

# SIGUARD Safety Systems

# 11



11/2	<b>Introduction</b>	
	<b>SIGUARD position switches</b>	
	<b>Standard position switches</b>	
11/4	General data	
11/6	Molded-plastic enclosures, 31 mm and 50 mm wide	
11/16	Molded-plastic enclosures, 40 mm wide	
11/21	Metal enclosures, 40 mm and 56 mm wide	
11/42	Position switches, open type	
11/44	Position switches with molded cable	
11/46	Accessories and spare parts	
	<b>Position switches with separate actuator</b>	
11/48	General data	
11/50	Molded-plastic enclosures, 31 mm wide	
11/53	Molded-plastic enclosures, 52 mm wide	
11/55	Metal enclosures, 40 mm wide	
	<b>Position switches with separate actuator and tumbler</b>	
11/57	General data	
11/59	Molded-plastic enclosures, locking force 1200 N	
11/61	Metal enclosures, locking force 1200 N	
11/63	Metal enclosures, locking force 2000 N	
	<b>AS-Interface position switches</b>	
IK PI <sup>1)</sup>	Molded-plastic and metal enclosures	
	<b>SIGUARD hinge switches</b>	
11/65	Molded-plastic enclosures	
	<b>SIGUARD magnetically operated switches</b>	
11/67	Magnetic monitoring systems	
	<b>SIGUARD cable-operated switches</b>	
11/69	Metal enclosures	
IK PI <sup>1)</sup>	AS-Interface cable-operated switches	
	<b>SIGUARD foot switches</b>	
11/75	Molded-plastic and metal enclosures	
	<b>SIGUARD two-hand operation consoles</b>	
11/77	Molded-plastic and metal enclosures	
	<b>SIGUARD safety combinations</b>	
11/78	General data	
11/80	Relay safety combinations	
11/85	Solid-state safety combinations	
	<b>Load feeders with integrated safety functions</b>	
11/92	General data	
11/95	Fuseless load feeders	
11/98	Fused load feeders	
	<b>SIGUARD light curtains and arrays</b>	
11/99	General data	
	<b>With integrated evaluation</b>	
11/102	Light curtains and arrays to Category 4	
	<b>With separate evaluation unit</b>	
11/107	Light curtains and arrays to Category 4	
IK PI <sup>1)</sup>	AS-Interface light curtains and arrays to Category 4	
11/110	Light curtains to Category 2	
11/112	Evaluation units	
	<b>Accessories</b>	
11/117	Mounting parts and other accessories	
	<b>SIGUARD laser scanners</b>	
11/120	Standard LS4 laser scanners	
11/124	– AS-Interface LS4 laser scanners	
11/124	– PROFIBUS DP LS4 laser scanners	
	<b>SIGUARD light barriers</b>	
11/125	Light barriers, Category 2 with evaluation unit	
11/125	Light barriers, Category 4	
	<b>SIGUARD switch strips</b>	
11/128	Switch strips to Category 4	
	<b>SIGUARD signaling columns</b>	
11/130	General data	
11/132	Signaling columns with 50 mm diameter	
11/134	Signaling columns with 70 mm diameter	
11/137	AS-Interface connection for signaling columns	
	<b>SIGUARD integrated signal lamps</b>	
11/138	Integrated signal lamps with 70 mm diameter	
	<b>Safety at work</b>	
11/140	System overview	
	1) See Catalog IK PI · 2004 Industrial Communication for Automation and Drives	

# SIGUARD Safety Systems

## Introduction

### Overview



3SE2



3SE2



3SE6



3SE7

	Position switches	Hinge switches	Magnetically operated switches	Cable-operated switches
<b>Enclosure</b>				
Molded plastic	✓	✓	✓	–
Metal	✓	–	–	✓
<b>Type</b>				
EN 50041	✓	–	–	–
EN 50047	✓	✓	–	–
Special type	✓	✓	✓	✓
Separate actuator	✓	–	–	–
<b>Switch blocks</b>				
Two-pole	✓	✓	✓	✓
Three-pole	✓	✓	–	–
Four-pole	✓	–	–	✓
<b>Terminals</b>				
Screw terminals	✓	✓	–	✓
Molded cable	–	–	✓	–
Plug-in connector	□	□	–	□
AS-Interface	✓	–	–	✓



3SE29



3SB38 6



8WD4



8WD5

	Foot switches	Two-hand operation consoles	Signaling columns	Integrated signal lamps
<b>Enclosure</b>				
Molded plastic	✓	✓	✓	✓
Metal	✓	✓	–	–
<b>Actuator</b>				
Pushbutton	✓	✓	–	–
Pressure switch	✓	✓	–	–
<b>Switch blocks</b>				
Two-pole	✓	✓	–	–
Four-pole	✓	–	–	–
<b>Terminals</b>				
Screw terminals	✓	✓	✓	✓
Spring-loaded terminals	–	–	✓	–
Molded cable	✓	–	–	–
AS-Interface	–	–	✓	–

✓ Standard  
 – not available  
 □ optional



	3TK28 3RA71 Safety combinations, load feeders	3RG78 4 Light curtains and arrays, light barriers	3RG78 3 Laser scanners	3RG78 5 Switch strips
<b>Enclosure</b>				
Molded plastic	✓	✓ (light barriers)	-	-
Metal	-	✓ (light curtains)	-	-
Molded plastic/metal	-	-	✓	✓
<b>Safety category</b>				
Up to Category 2 acc. to EN 954-1	-	✓	-	-
Up to Category 3 acc. to EN 954-1	✓	-	✓	-
Up to Category 4 acc. to EN 954-1	✓	✓	-	✓
Up to Type 2 acc. to EN 61496-1	-	✓	-	-
Up to Type 3 acc. to EN 61496-1	-	-	✓	-
Up to Type 4 acc. to EN 61496-1	-	✓	-	✓
<b>Evaluation</b>				
Separate evaluation device	-	✓	✓	✓
Integrated evaluation	-	✓	-	-
<b>Rated output, standard motors</b>				
Load feeders	up to 11 kW at 400 V	-	-	-
<b>Terminals</b>				
Plug-in connector	-	✓	-	-
Screw terminals	✓	✓	✓	-
Spring-loaded terminals	✓	-	-	-
Molded cable	-	-	-	✓
AS-Interface	-	✓	✓	-
PROFIBUS DP	-	-	✓	-

# SIGUARD Position Switches

## Standard Position Switches

### General data

#### Overview



#### Area of application

The function of the 3SE position switches is to generate electrical signals corresponding to the positions of the moving machine parts.

The units are suitable for use in any climate.

#### Specifications

IEC 60947-5-1 or EN 60947-5-1

The protective measure of "total insulation" by the molded-plastic enclosure is guaranteed by the use of molded-plastic screw-glands.

The 3SE2 200 and 3SE2 210 position switches with molded-plastic enclosures comply with the accident prevention guidelines of the Swiss Accident Insurance Authority (SUVA). The following actuator types have been approved:

- Plain plunger (metal enclosure)                    -. B
- Rounded plunger   -. C
- Roller plunger    -. D
- Roller lever   -. E
- Angular roller lever                                   -. F
- Twist lever   -. G or -. GW
- Rounded plunger M 18 x 1 (molded-plastic enclosure)                   -. L
- Roller plunger M 18 x 1 (molded-plastic enclosure)                   -. M

In addition, the open-type 3SE3 position switches and the 3SE3 replacement switch blocks are also permitted.

#### Safety position switch

For controls that comply with IEC 60204-1 or EN 60204-1, the 3SE devices are suitable for use as safety position switches.

To secure position switches with a safety function against changes in their position, keyed techniques must be employed on installation, such as:

- Fixing by means of round holes
- For longitudinal holes, guide pins and stops must also be used.

#### Design

The 3SE2 position switches are in either a narrow or wide enclosure made of fiber-glass strengthened, flame-retardant molded plastic or cast aluminum.

The position switches in a narrow enclosure comply with the standards in terms of their enclosure and actuator as well as their fixing dimensions and switching points:

- EN 50047 for rounded plunger, roller plunger, roller and twist lever actuators
  - 3SE2 200 series with molded-plastic enclosure.
- EN 50041 for rounded plunger, roller plunger, twist lever and rod actuators
  - 3SE2 230 series with molded-plastic enclosure
  - 3SE2 120 series with metal enclosure

The narrow enclosures have one and the wide enclosures have two or three cable entries. The cable entry has a metric thread M 20 x 1.5 for cable glands with 6 mm long threads (see [Accessories](#)).

#### Actuators

All actuators can be retro-fitted or exchanged for another version. They can also be repositioned every 90° so that the switches can be operated from any of the four sides.

- The position switches with roller lever are approached perpendicular to the plunger axis and position switches with angular roller lever are approached in parallel with the plunger axis.
- The actuators with twist levers and rods can be operated from both sides and be positioned in increments of 10° on the driving shaft. The rollers of the actuators are made of wear resistant molded plastic.
- The spring rod can be approached from any direction.
- For the fork lever actuators (metal enclosure only), there are two defined switching positions. The actuating element causes changeover from one position to the other. This actuator is suitable for two-channel operation.

The open-type 3SE3 0 position switches are only available with plunger actuators.

**Important:** The position switches must not be used as an end stop.

#### Contacts

The position switches with molded-plastic enclosures are available with 2 contacts; the position switches with metal enclosures are available with 2, 3 or 4 contacts. The contacts can be snap-action contacts, slow-action contacts or slow-action make-before-break contacts.

The movable normally closed and normally open switch contacts are electrically isolated from each other and are suitable for switching voltages of different potentials.

#### Contact reliability

The movable contacts are double-break contacts. This ensures an extremely high contact stability, even when the devices are switching low voltages and currents, e.g. DC 5 V/1 mA.

The switching point of the snap-action contacts is independent of the switching corrosion:

The contact chamber is covered to prevent ingress of foreign bodies.

#### Functions

##### Positive opening →

The NC contacts of the switch are forced open mechanically, positively-driven and reliably by the plunger (positive-opening).

In order to ensure this positive opening, the position switches must be actuated in such a way that the nominal values for the positive opening are substantially exceeded.

# SIGUARD Position Switches

## Standard Position Switches

### General data

#### Technical specifications

Type	3SE2 1, 3SE2 2, 3SE2 3, 3SE2 4, 3SE3 0		exception: 3SE2 1.0-8..00, 3SE2 2.0-8..00,	
<b>Standards</b>	IEC 60947-5-1, EN 60947-5-1			
<b>Rated insulation voltage <math>U_i</math></b>	V	500		
<b>Pollution degree</b> acc. to EN 60664		Class 3		
<b>Rated operating voltage <math>U_e</math></b>	V	AC 500; over AC 380 V only for equal potential		
<b>Conventional thermal current <math>I_{th}</math></b>	A	10		
<b>Rated operating current <math>I_e</math></b>				
<ul style="list-style-type: none"> <li>For alternating current 40 to 60 Hz</li> <li>- at 24 V</li> <li>- at 125 V</li> <li>- at 230 V</li> <li>- at 400 V</li> <li>- at 500 V</li> </ul>	A	$I_e$ / AC-12 10	$I_e$ / AC-15 10	
<ul style="list-style-type: none"> <li>For direct current</li> <li>- at 24 V</li> <li>- at 48 V</li> <li>- at 110 V</li> <li>- at 220 V</li> <li>- at 440 V</li> </ul>	A	$I_e$ / DC-12 10	$I_e$ / DC-13 10	
<ul style="list-style-type: none"> <li>- at 24 V</li> <li>- at 48 V</li> <li>- at 110 V</li> <li>- at 220 V</li> <li>- at 440 V</li> </ul>	A	6	4	
<ul style="list-style-type: none"> <li>- at 110 V</li> <li>- at 220 V</li> <li>- at 440 V</li> </ul>	A	4	1	
<ul style="list-style-type: none"> <li>- at 220 V</li> <li>- at 440 V</li> </ul>	A	1	0.4	
<ul style="list-style-type: none"> <li>- at 440 V</li> </ul>	A	0.5	0.2	
<b>Short circuit protection<sup>1)</sup></b> , DIAZED fuse links				
<ul style="list-style-type: none"> <li>Operational class gL/gG</li> <li>Characteristic quick</li> </ul>	A	6	10	
<b>Mechanical endurance</b>		30 × 10 <sup>6</sup> operating cycles		15 × 10 <sup>6</sup> operating cycles
<b>Electrical endurance</b>		10 × 10 <sup>6</sup> operating cycles		
<ul style="list-style-type: none"> <li>With 3RH11, 3RT10 16 to 3RT10 26 contactors</li> <li>For AC-15 duty</li> <li>For DC-13 duty</li> </ul>		0.5 × 10 <sup>6</sup> operating cycles when interrupting $I_e$ / AC-15 at 230 V		
		With DC the contact endurance depends not only on the breaking current but also on the voltage, the circuit inductance and the speed of switching. No generally valid information can be given.		
<b>Operating frequency</b> with 3RH11, 3RT10 16 to 3RT10 26 contactors		6 × 10 <sup>3</sup> operating cycles/h		
<b>Operating accuracy</b> for repeated switching, measured at the plunger of the switch block	mm	0.05		
<b>Operating point</b> with snap-action contacts		Independent of contact wear, constant throughout the life of the switch		
<b>Ⓢ, Ⓜ and Ⓜ ratings</b>				
<ul style="list-style-type: none"> <li>Rated voltage</li> <li>Continuous current</li> <li>Switching capacity</li> </ul>	V	600	300	
	A	10	10	
		Heavy Duty, A 600/Q 600	Heavy Duty, A 300/Q 300	

Type	3SE2 200	3SE2 230	3SE2 210	3SE2 120	3SE2 100, 3SE2 303, 3SE2 404	3SE3 0
<b>Enclosure</b>	Fiber-glass strengthened thermoplastic			Aluminum (GD - AlSi 12)		-
<b>Degree of protection</b> acc. to IEC 60529	IP67	IP66	IP67	IP67		IP20
<b>Ambient temperature</b>	-30 to +85 °C					
<ul style="list-style-type: none"> <li>in operation</li> <li>for storage, transport</li> </ul>						
<b>Mounting position</b>	Any					
<b>Cable entry</b>	1 × (M 20 × 1.5)		2 × (M 20 × 1.5)	1 × (M 20 × 1.5)	3 × (M 20 × 1.5)	-
<b>Conductor cross-sections</b>						
<ul style="list-style-type: none"> <li>Solid</li> <li>Finely stranded with end sleeve</li> </ul>	2 × 2.5 mm <sup>2</sup> 2 × 1.5 mm <sup>2</sup>					
<b>Protective conductor terminal</b> inside enclosure	-			M 3.5		-

1) Without any welds according to IEC 60947-5-1.









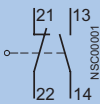
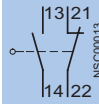

# SIGUARD Position Switches

## Standard Position Switches

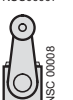
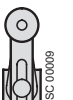
Molded-plastic enclosures, 31 and 50 mm wide

### Selection and ordering data

2 contacts · Moving double-break contacts · IP67 degree of protection · EN 50047 · Special width 50 mm

Actuator <sup>1)</sup>	Oper. mech. design to EN 50047	Enclosure width	DT	Position switches with 2 slow-action contacts	PS*	Weight per PU approx.	DT	Position switches with 2 snap-action contacts	PS*	Weight per PU approx.
		mm		 Ident. No. 11 acc. to EN 50013				 Ident. No. 11 acc. to EN 50013		
				Order No.		kg		Order No.		kg
 NSC00004	<b>Rounded plunger</b>	B	▶	→ <b>3SE2 200-0C</b>	1 unit	0.058	▶	→ <b>3SE2 200-1C</b>	1 unit	0.057
		–	B	→ <b>3SE2 210-0C</b>	1 unit	0.077	▶	→ <b>3SE2 210-1C</b>	1 unit	0.078
 NSC00005	<b>Roller plunger</b>	C	▶	→ <b>3SE2 200-0D</b>	1 unit	0.065	▶	→ <b>3SE2 200-1D</b>	1 unit	0.067
		–	B	→ <b>3SE2 210-0D</b>	1 unit	0.084	▶	→ <b>3SE2 210-1D</b>	1 unit	0.085
 NSC00006	<b>Roller lever</b>	E	▶	→ <b>3SE2 200-0E</b>	1 unit	0.064	▶	→ <b>3SE2 200-1E</b>	1 unit	0.065
		–	B	→ <b>3SE2 210-0E</b>	1 unit	0.083	▶	→ <b>3SE2 210-1E</b>	1 unit	0.085
 NSC00007	<b>Angular roller lever</b>	–	▶	→ <b>3SE2 200-0F</b>	1 unit	0.064	▶	→ <b>3SE2 200-1F</b>	1 unit	0.065
		–	B	→ <b>3SE2 210-0F</b>	1 unit	0.083	▶	→ <b>3SE2 210-1F</b>	1 unit	0.084
 NSC00008	<b>Twist lever <sup>2)</sup></b>	• finely adjustable from 10° to 10°	▶	→ <b>3SE2 200-0G</b>	1 unit	0.082	▶	→ <b>3SE2 200-1G</b>	1 unit	0.083
		–	B	→ <b>3SE2 210-0G</b>	1 unit	0.097	▶	→ <b>3SE2 210-1G</b>	1 unit	0.098
 NSC00009	• adjustable length, finely adjustable from 10° to 10°	–	B	<b>3SE2 200-0U</b>	1 unit	0.095	B	<b>3SE2 200-1U</b>	1 unit	0.098
		–	B	<b>3SE2 210-0U</b>	1 unit	0.110	B	<b>3SE2 210-1U</b>	1 unit	0.113
 NSC00010	<b>Rod actuator, finely adjustable from 10° to 10°</b>	• Molded-plastic rod	–	<b>3SE2 200-0W</b>	1 unit	0.099	B	<b>3SE2 200-1W</b>	1 unit	0.098
		–	B	<b>3SE2 210-0W</b>	1 unit	0.114	B	<b>3SE2 210-1W</b>	1 unit	0.117
	• Aluminum rod	–	B	<b>3SE2 200-0V</b>	1 unit	0.105	B	<b>3SE2 200-1V</b>	1 unit	0.105
		–	B	<b>3SE2 210-0V</b>	1 unit	0.120	B	<b>3SE2 210-1V</b>	1 unit	0.121
	• Spring rod	–	B	<b>3SE2 200-0S</b>	1 unit	0.113	B	<b>3SE2 200-1S</b>	1 unit	0.113
		–	B	<b>3SE2 210-0S</b>	1 unit	0.130	B	<b>3SE2 210-1S</b>	1 unit	0.130
 NSC00015	<b>Spring rod</b>	–	–	–			B	<b>3SE2 200-1R</b>	1 unit	0.090
		–	B	–			B	<b>3SE2 210-1R</b>	1 unit	0.106
 NSC00011	<b>Rounded plunger, central fixing with M 18 x 1 thread</b>	–	B	→ <b>3SE2 200-0L</b>	1 unit	0.084	B	→ <b>3SE2 200-1L</b>	1 unit	0.085
		–	B	→ <b>3SE2 210-0L</b>	1 unit	0.100	B	→ <b>3SE2 210-1L</b>	1 unit	0.100
 NSC00012	<b>Roller plunger, central fixing with M 18 x 1 thread</b>	–	B	→ <b>3SE2 200-0M</b>	1 unit	0.085	B	→ <b>3SE2 200-1M</b>	1 unit	0.086
		–	B	→ <b>3SE2 200-0M</b>	1 unit	0.085	B	→ <b>3SE2 210-1M</b>	1 unit	0.100
 NSC00004	<b>Position switch with teflon plunger</b> Optimized for lateral operation and enhanced wear characteristics	31	–	–			B	<b>3SE2 200-1XH</b>	1 unit	0.065
		50	–	–			B	<b>3SE2 210-1XH</b>	1 unit	0.075
 NSC00004	<b>Position switches with short-stroke switch block</b> operating travel 1.2 mm, differential travel 0.6 mm	31	–	–			B	<b>3SE2 200-1CV01</b>	1 unit	0.058
		50	–	–			B	<b>3SE2 210-1CV01</b>	1 unit	0.075

For operation, operating speed and travel, see Pages 11/11 to 11/15.  
For reusable packaging, see Appendix.

→ Positive opening according to IEC 60947-5-1, Appendix K.

- 1) The actuator heads can be subsequently replaced with other designs (see Accessories, Page 11/9).
- 2) Special version for applications in extremely dusty environments. Order No. has to be modified as follows:  
3SE2 200-0G in 3SE2 200-0XJ  
3SE2 200-1G in 3SE2 200-1XG.











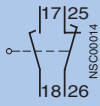

# SIGUARD Position Switches

## Standard Position Switches

Molded-plastic enclosures, 31 and 50 mm wide

2 contacts · Moving double-break contacts · IP67 degree of protection · EN 50047 · Special width 50 mm

Actuator 1)	Actuator design to EN 50047	Enclosure width	DT	Position switches with 2 slow-action make-before-break contacts	PS*	Weight per PU approx.	DT	Position switches with 2 slow-action contacts	PS*	Weight per PU approx.	
		mm		 Ident. No. <b>11</b> acc. to EN 50013				 Ident. No. <b>20</b> acc. to EN 50013			
				Order No.		kg		Order No.		kg	
	<b>Rounded plunger</b>	B	31	C	→ <b>3SE2 200-3C</b>	1 unit	0.057	B	<b>3SE2 200-7C</b>	1 unit	0.056
		–	50	C	→ <b>3SE2 210-3C</b>	1 unit	0.076		–		
	<b>Roller plunger</b>	C	31	B	→ <b>3SE2 200-3D</b>	1 unit	0.065	B	<b>3SE2 200-7D</b>	1 unit	0.065
		–	50	B	→ <b>3SE2 210-3D</b>	1 unit	0.083		–		
	<b>Roller lever</b>	E	31	C	→ <b>3SE2 200-3E</b>	1 unit	0.063	B	<b>3SE2 200-7E</b>	1 unit	0.063
		–	50	B	→ <b>3SE2 210-3E</b>	1 unit	0.080		–		
	<b>Angular roller lever</b>	–	31	C	→ <b>3SE2 200-3F</b>	1 unit	0.064	B	<b>3SE2 200-7F</b>	1 unit	0.066
		–	50	B	→ <b>3SE2 210-3F</b>	1 unit	0.070		–		
	<b>Twist lever</b>										
	• finely adjustable from 10° to 10°	A	31	B	→ <b>3SE2 200-3G</b>	1 unit	0.082	B	<b>3SE2 200-7G</b>	1 unit	0.081
		–	50	B	→ <b>3SE2 210-3G</b>	1 unit	0.097		–		
	• adjustable length, finely adjustable from 10° to 10°	–	31	B	<b>3SE2 200-3U</b>	1 unit	0.097	B	<b>3SE2 200-7U</b>	1 unit	0.096
		–	50	C	<b>3SE2 210-3U</b>	1 unit	0.090		–		
	<b>Rod actuator,</b> finely adjustable from 10° to 10°										
	• Molded-plastic rod	–	31	B	<b>3SE2 200-3W</b>	1 unit	0.095	C	<b>3SE2 200-7W</b>	1 unit	0.060
		–	50	B	<b>3SE2 210-3W</b>	1 unit	0.090		–		
	• Aluminium rod	–	31	B	<b>3SE2 200-3V</b>	1 unit	0.103	B	<b>3SE2 200-7V</b>	1 unit	0.060
		–	50	B	<b>3SE2 210-3V</b>	1 unit	0.090		–		
	• Spring rod	–	31	B	<b>3SE2 200-3S</b>	1 unit	0.112	B	<b>3SE2 200-7S</b>	1 unit	0.111
		–	50	B	<b>3SE2 210-3S</b>	1 unit	0.100		–		
	<b>Rounded plunger,</b> central fixing with M 18 × 1 thread	–	31	B	→ <b>3SE2 200-3L</b>	1 unit	0.085	B	<b>3SE2 200-7L</b>	1 unit	0.085
		–	50	B	→ <b>3SE2 210-3L</b>	1 unit	0.060		–		
	<b>Roller plunger,</b> central fixing with M 18 × 1 thread	–	31	B	→ <b>3SE2 200-3M</b>	1 unit	0.087	B	<b>3SE2 200-7M</b>	1 unit	0.060
		–	50	B	→ <b>3SE2 210-3M</b>	1 unit	0.100		–		

For operation, operating speed and travel, see Pages 11/11 to 11/15.  
For reusable packaging, see Appendix.

→ Positive opening according to IEC 60947-5-1, Appendix K.







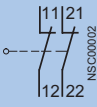
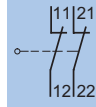

1) The actuator heads can be subsequently replaced with other versions (see Accessories, Page 11/9).

# SIGUARD Position Switches

## Standard Position Switches

Molded-plastic enclosures, 31 and 50 mm wide

2 contacts · Moving double-break contacts · IP67 degree of protection · EN 50047 · Special width 50 mm

Actuator 1)	Actuator design to EN 50047	Enclosure width	DT	Position switches with 2 slow-action contacts	PS*	Weight per PU approx.	DT	Position switches with 2 snap-action contacts	PS*	Weight per PU approx.
		mm		 Ident.No. <b>02</b> acc. to EN 50013				 Ident.No. <b>02</b> acc. to EN 50013		
				Order No.		kg		Order No.		kg
 NSC00004	<b>Rounded plunger</b>	B	31	B	→ 3SE2 200-6C	1 unit	0.070	▶ → 3SE2 200-8CV00	1 unit	0.098
	–	–	50	–	–	–	–	→ 3SE2 210-8CV00	1 unit	0.105
 NSC00005	<b>Roller plunger</b>	C	31	B	→ 3SE2 200-6D	1 unit	0.065	A → 3SE2 200-8DV00	1 unit	0.104
	–	–	50	–	–	–	–	A → 3SE2 210-8DV00	1 unit	0.114
 NSC00006	<b>Roller lever</b>	E	31	B	→ 3SE2 200-6E	1 unit	0.063	A → 3SE2 200-8EV00	1 unit	0.105
	–	–	50	–	–	–	–	A → 3SE2 210-8EV00	1 unit	0.113
 NSC00007	<b>Angular roller lever</b>	–	31	B	→ 3SE2 200-6F	1 unit	0.070	A → 3SE2 200-8FV00	1 unit	0.106
	–	–	50	–	–	–	–	A → 3SE2 210-8FV00	1 unit	0.124
 NSC00008	<b>Twist lever</b>			B	→ 3SE2 200-6G	1 unit	0.080	A → 3SE2 200-8GV00	1 unit	0.134
	• finely adjustable from 10° to 10°	A	31	B	–	–	–	A → 3SE2 210-8GV00	1 unit	0.147
	• adjustable length, finely adjustable from 10° to 10°	–	31	B	3SE2 200-6U	1 unit	0.095	B 3SE2 200-8UV00	1 unit	0.152
	–	–	50	–	–	–	–	B 3SE2 210-8UV00	1 unit	0.145
 NSC00009	<b>Rod actuator, finely adjustable from 10° to 10°</b>									
	• Molded-plastic rod	–	31	B	3SE2 200-6W	1 unit	0.096	B 3SE2 200-8WV00	1 unit	0.158
	–	–	50	–	–	–	–	B 3SE2 210-8WV00	1 unit	0.174
	• Aluminium rod	–	31	B	3SE2 200-6V	1 unit	0.060	B 3SE2 200-8V00	1 unit	0.167
	–	–	50	–	–	–	–	B 3SE2 210-8V00	1 unit	0.179
	• Spring rod	–	31	B	3SE2 200-6S	1 unit	0.110	B 3SE2 200-8SV00	1 unit	0.090
 NSC00010	–	–	50	–	–	–	–	B 3SE2 210-8SV00	1 unit	0.130
	<b>Spring rod</b>	–	31	–	–	–	–	A 3SE2 200-8RV00	1 unit	0.125
 NSC00011	<b>Rounded plunger, central fixing with M 18 x 1 thread</b>	–	31	B	→ 3SE2 200-6L	1 unit	0.060	–	–	–
	<b>Roller plunger, central fixing with M 18 x 1 thread</b>	–	31	B	→ 3SE2 200-6M	1 unit	0.085	–	–	–

For operation, operating speed and travel, see Pages 11/11 to 11/15.

For reusable packaging, see Appendix.

→ Positive opening according to IEC 60947-5-1, Appendix K.

1) The actuator heads can be subsequently replaced with other versions (see Accessories, Page 11/9).



# SIGUARD Position Switches

## Standard Position Switches









Molded-plastic enclosures, 31 and 50 mm wide

### Accessories

#### Actuators for 3SE2 200 and 3SE2 210 position switches

The actuator heads of the position switches can be subsequently exchanged.

The basic version is the 3SE2 2.0-C rounded plunger. The other actuator heads can be plugged onto it (exception: position switch with teflon plunger).

	Actuator with fixing screws	Can be used for position switches	DT	Order No.	PS*	Weight per PU approx. kg
	<b>Roller plunger</b>	3SE2 200-. D, 3SE2 210-. D	▶	<b>3SX3 170</b>	1 unit	0.011
	<b>Roller lever</b>	3SE2 200-. E, 3SE2 210-. E	▶	<b>3SX3 171</b>	1 unit	0.010
	<b>Angular roller lever</b>	3SE2 200-. F, 3SE2 210-. F	▶	<b>3SX3 172</b>	1 unit	0.010
	<b>Twist lever</b> • finely adjustable from 10° to 10°	3SE2 200-. G, 3SE2 210-. G	▶	<b>3SX3 173</b>	1 unit	0.025
	• adjustable length, finely adjustable from 10° to 10°	3SE2 200-. U, 3SE2 210-. U	▶	<b>3SX3 174</b>	1 unit	0.040
	<b>Rod actuator,</b> finely adjustable from 10° to 10° • Molded-plastic rod	3SE2 200-. W, 3SE2 210-. W	▶	<b>3SX3 175</b>	1 unit	0.040
	• Aluminum rod	3SE2 200-. V, 3SE2 210-. V	▶	<b>3SX3 176</b>	1 unit	0.048
	• Spring rod	3SE2 200-. S, 3SE2 210-. S	B	<b>3SX3 177</b>	1 unit	0.055
	<b>Spring rod <sup>1)</sup></b>	3SE2 200-. R, 3SE2 210-. R	▶	<b>3SX3 178</b>	1 unit	0.025
	<b>Rounded plunger,</b> central fixing with M 18 × 1 thread	3SE2 200-. L, 3SE2 210-. L	B	<b>3SX3 180</b>	1 unit	0.030
	<b>Roller plunger,</b> central fixing with M 18 × 1 thread	3SE2 200-. M, 3SE2 210-. M	▶	<b>3SX3 181</b>	1 unit	0.027

1) Only for snap-action contacts.

# SIGUARD Position Switches

## Standard Position Switches

Molded-plastic enclosures, 31 and 50 mm wide

### Dimension drawings

**3SE2 200, narrow enclosure acc. to EN 50047, with rounded plunger, Type B**

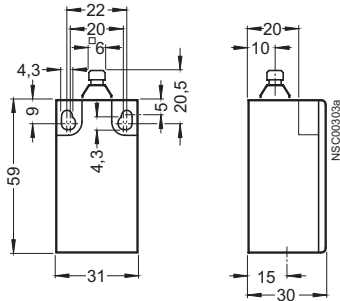

**3SE2 210, wide enclosure, with rounded plunger**

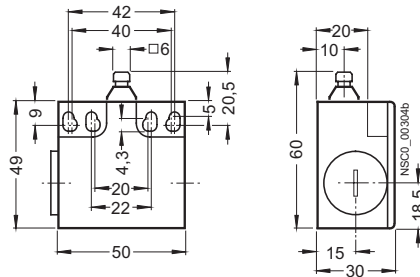

**Roller plunger, Type C**

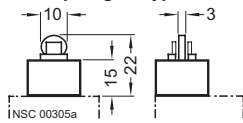

**Roller lever, Type E**

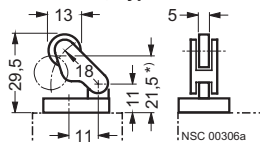

\* Lever in final position

**Angular roller lever**

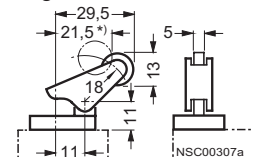

\* Lever in final position

**Twist lever, Type A**

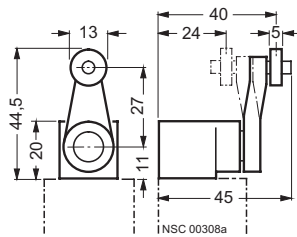

**Rounded plunger, central fixing with M 18 x 1 thread**

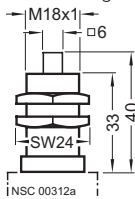

**Roller plunger, central fixing with M 18 x 1 thread**

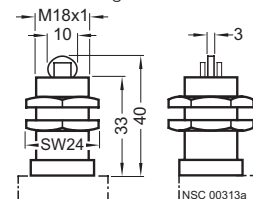

**Twist lever, adjustable length**

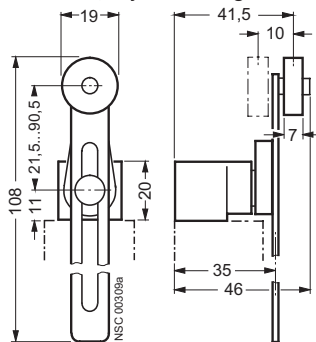

**Rod actuator**

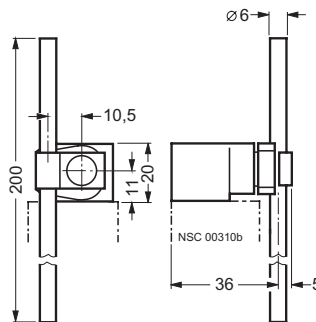

**Spring rod**

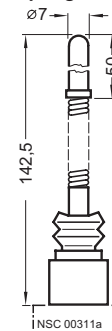

# SIGUARD Position Switches

## Standard Position Switches

Molded-plastic enclosures, 31 and 50 mm wide

### Further information

#### Operation, operating speed and travel or angle of actuators

Bars, cams, stops, etc. are used as actuating devices. The shape of the actuating device must provide the given angles for the leading and trailing edges.

#### Actuating speed in the direction of plunger axis

The actuating speed in the case of position switches with slow-action contacts is not permitted to go lower than 15 mm/s for DC and 1 mm/s for AC. Position switches with snap-action contacts should be used when the speeds are lower.

Operation by a bar	Switch blocks	Nominal travel	Switch blocks	Nominal travel
○ operating point acc. to EN 50047	Terminal designation acc. to EN 50013	0-line reference line acc. to EN 50047		
$V_{max}$ max. operating speed		S travel acc. to EN 50047		
S travel difference		■ contact closed		
H direction of operation		□ contact open		
→		* operating point on return		
		** positive opening to IEC 60947-5-1		

### Rounded plungers, Type B

3SE2 200-C,  
3SE2 210-C

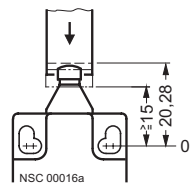

$V_{max} = 1 \text{ m/s}$

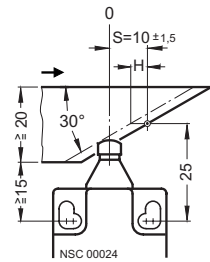

$V_{max} = 0.5 \text{ m/s}$   
Minimum force required in direction of operation: 9 N

#### Slow-action contacts

1 NO + 1 NC

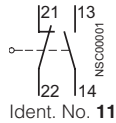

Ident. No. 11

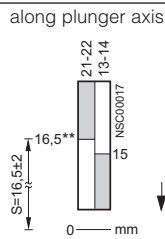

1 NO + 1 NC with make-before-break

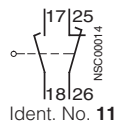

Ident. No. 11

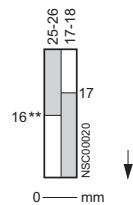

lateral actuation

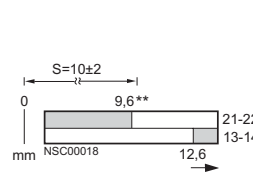

2 NC

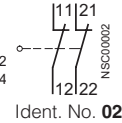

Ident. No. 02

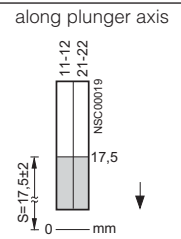

2 NO

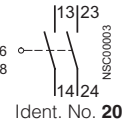

Ident. No. 20

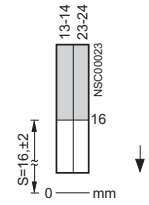

#### Snap-action contacts

1 NO + 1 NC

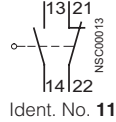

Ident. No. 11

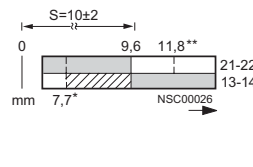
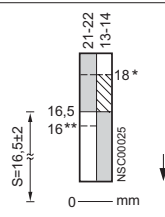

### Roller plungers, Type C

3SE2 200-D,  
3SE2 210-D

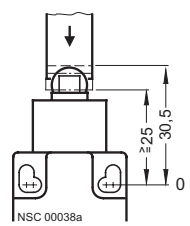

$V_{max} = 1 \text{ m/s}$

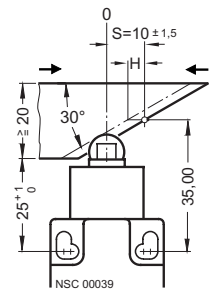

$V_{max} = 1 \text{ m/s}$   
Minimum force required in direction of operation: 9 N

#### Slow-action contacts

1 NO + 1 NC

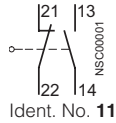

Ident. No. 11

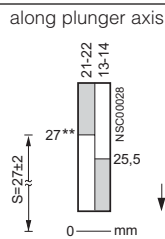

1 NO + 1 NC with make-before-break

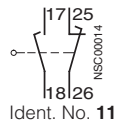

Ident. No. 11

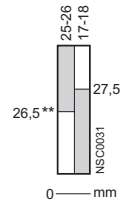

lateral actuation

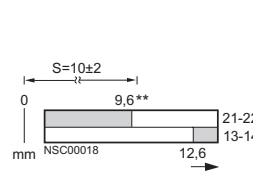

2 NC

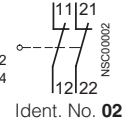

Ident. No. 02

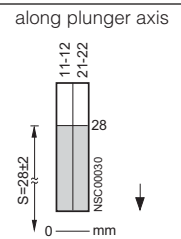

2 NO

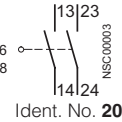

Ident. No. 20

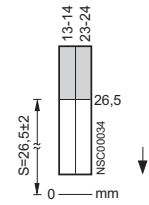

#### Snap-action contacts

1 NO + 1 NC

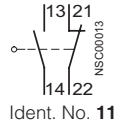

Ident. No. 11

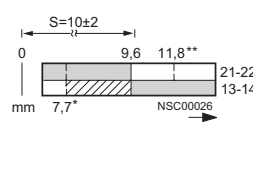
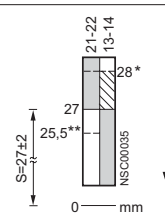

# SIGUARD Position Switches

## Standard Position Switches

Molded-plastic enclosures, 31 and 50 mm wide

Operation by a bar		Switch blocks	Nominal travel	Switch blocks	Nominal travel
○	operating point acc. to EN 50047	Terminal designation acc. to EN 50013	O-line S		reference line acc. to EN 50047 travel acc. to EN 50047
$v_{max}$	max. operating speed		■		contact closed
S	travel acc. to EN 50047		□		contact open
H	travel difference		*		operating point on return
→	direction of operation		**		positive opening to IEC 60947-5-1

### Roller levers, Type E

3SE2 200-E,  
3SE2 210-E

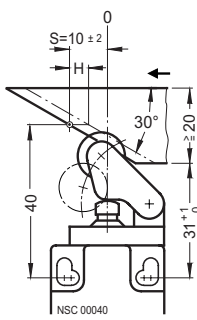

$v_{max} = 1 \text{ m/s}$

Minimum force required in direction of operation: 9 N

#### Slow-action contacts

1 NO + 1 NC

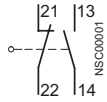

Ident. No. 11

1 NO + 1 NC  
with make-before-break

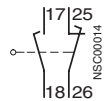

Ident. No. 11

lateral actuation

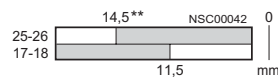
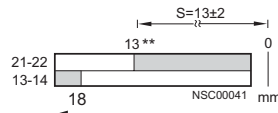

#### Snap-action contacts

1 NO + 1 NC

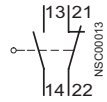

Ident. No. 11

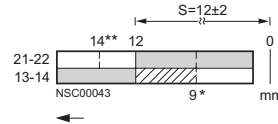

### Angular roller levers

3SE2 200-F,  
3SE2 210-F

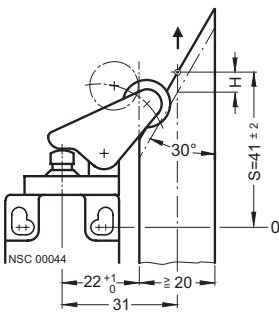

$v_{max} = 1 \text{ m/s}$

Minimum force required in direction of plunger axis: 9 N

The example for approach is only applicable to 3SE2 200.

It is not possible in this way for 3SE2 210.

#### Slow-action contacts

1 NO + 1 NC

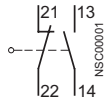

Ident. No. 11

along plunger axis

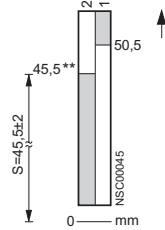

1 NO + 1 NC  
with make-before-break

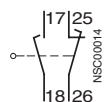

Ident. No. 11

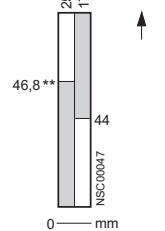

along plunger axis

2 NC

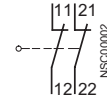

Ident. No. 02

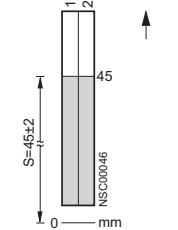

2 NO

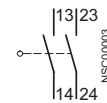

Ident. No. 20

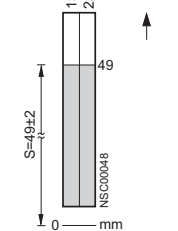

#### Snap-action contacts

1 NO + 1 NC

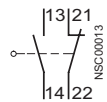

Ident. No. 11

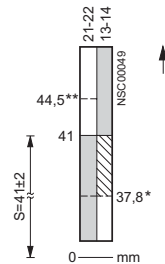

2 NC

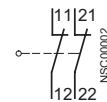

Ident. No. 02

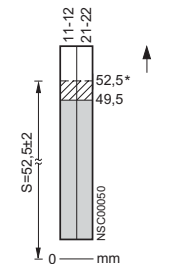

# SIGUARD Position Switches

## Standard Position Switches

Molded-plastic enclosures, 31 and 50 mm wide

Operation by a bar		Switch blocks	Nominal travel	Switch blocks	Nominal travel
○	operating point acc. to EN 50047	Terminal designation acc. to EN 50013	O-line reference line acc. to EN 50047		
$v_{max}$	max. operating speed		S travel acc. to EN 50047		
S	travel acc. to EN 50047		■ contact closed		
H	travel difference		□ contact open		
→	direction of operation		* operating point on return		
			** positive opening to IEC 60947-5-1		

### Twist levers, Type A

finely adjustable from 10° to 10°

3SE2 200-G

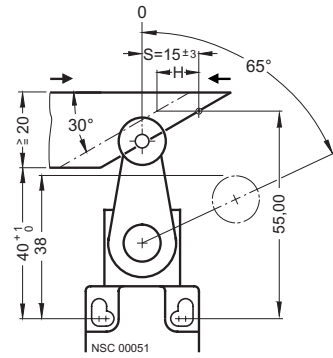

$v_{max} = 1$  m/s

Minimum force required in direction of operation: 18 N

### Slow-action contacts

1 NO + 1 NC

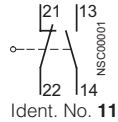

lateral actuation

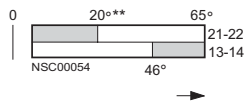
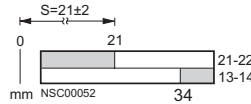

1 NO + 1 NC with make-before-break

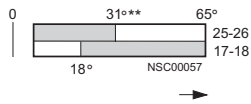
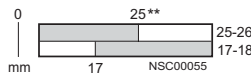
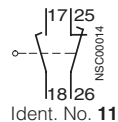

2 NC

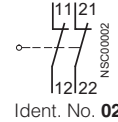

lateral actuation

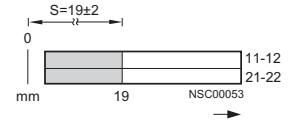

2 NO

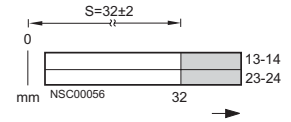
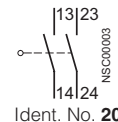

### Snap-action contacts

1 NO + 1 NC

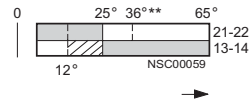
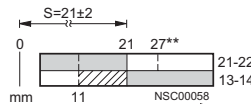
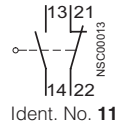

### Twist levers

adjustable length, finely adjustable from 10° to 10°

3SE2 200-U, 3SE2 210-U

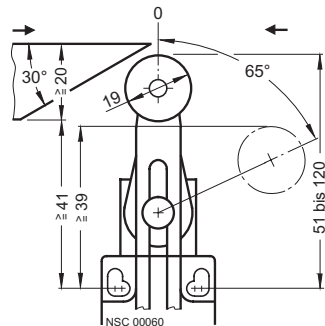

$v_{max} = 1$  m/s

Minimum force required in direction of operation: 18 N

### Slow-action contacts

1 NO + 1 NC

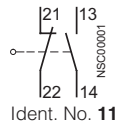

lateral actuation

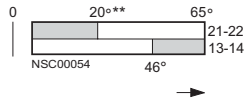

1 NO + 1 NC with make-before-break

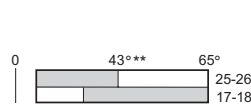
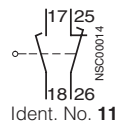

2 NC

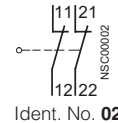

lateral actuation

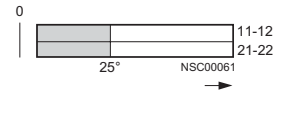

2 NO

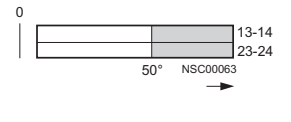
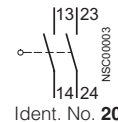

### Snap-action contacts

1 NO + 1 NC

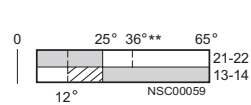
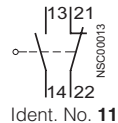

11

# SIGUARD Position Switches

## Standard Position Switches

Molded-plastic enclosures, 31 and 50 mm wide

Operation by a bar		Switch blocks	Nominal travel		Switch blocks	Nominal travel
○	operating point acc. to EN 50047	Terminal designation acc. to EN 50013	0-line	reference line acc. to EN 50047		
$v_{max}$	max. operating speed		■	contact closed		
→	direction of operation		□	contact open		
			*	operating point on return		

### Rod actuators

finely adjustable from 10° to 10°

3SE2 200-W,  
3SE2 210-W

3SE2 200-V,  
3SE2 210-V

3SE2 200-S,  
3SE2 210-S

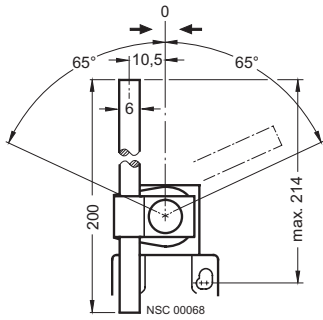

$v_{max} = 1.5$  m/s

Minimum force required  
in direction of operation: 18 N

### Spring rods

3SE2 200-1R,  
3SE2 210-1R

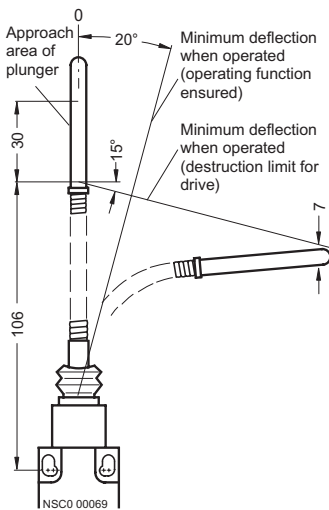

$v_{max} = 1.5$  m/s

Minimum force required  
in direction of operation: 18 N

### Slow-action contacts

1 NO + 1 NC

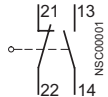

Ident. No. 11

1 NO + 1 NC  
with make-before-break

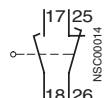

Ident. No. 11

### Snap-action contacts

1 NO + 1 NC

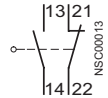

Ident. No. 11

in direction of rotation

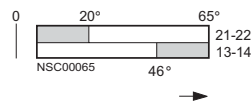

2 NC

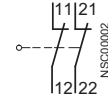

Ident. No. 02

2 NO

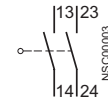

Ident. No. 20

in direction of rotation

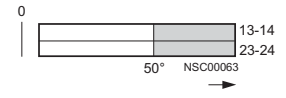
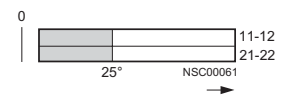

lateral actuation

### Snap-action contacts

1 NO + 1 NC

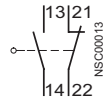

Ident. No. 11

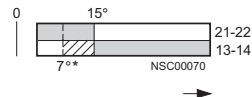





# SIGUARD Position Switches

## Standard Position Switches

Molded-plastic enclosures, 31 and 50 mm wide

Operation by a bar	Switch blocks	Nominal travel	Switch blocks	Nominal travel
○ operating point acc. to EN 50047	Terminal designation acc. to EN 50013	0-line reference line acc. to EN 50047		
$v_{max}$ max. operating speed		S travel acc. to EN 50047		
S travel acc. to EN 50047		 contact closed		
H travel difference		 contact open		
→ direction of operation		* operating point on return		
		** positive opening to IEC 60947-5-1		

### Rounded plungers

Central fixing with M 18 thread

3SE2 200-L,  
3SE2 210-L

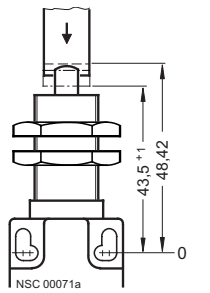

$v_{max} = 1 \text{ m/s}$

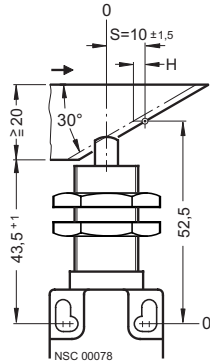

$v_{max} = 0.5 \text{ m/s}$

Minimum force required in direction of operation: 9 N

### Slow-action contacts

1 NO + 1 NC

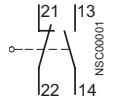

Ident. No. 11

along plunger axis

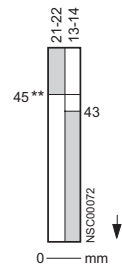

lateral actuation

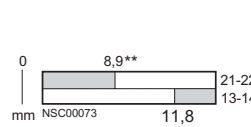

2 NC

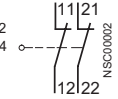

Ident. No. 02

along plunger axis

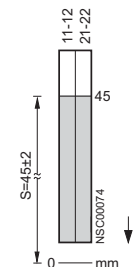

1 NO + 1 NC  
with make-before-break

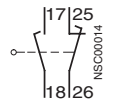

Ident. No. 11

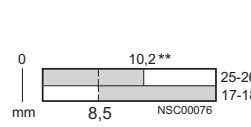
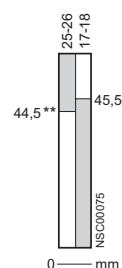

2 NO

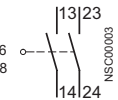

Ident. No. 20

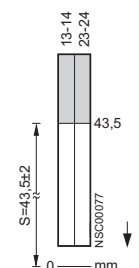

### Snap-action contacts

1 NO + 1 NC

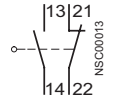

Ident. No. 11

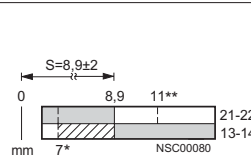
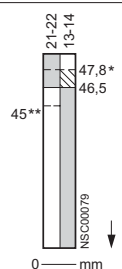

### Roller plungers

Central fixing with M 18 thread

3SE2 200-M,  
3SE2 210-M

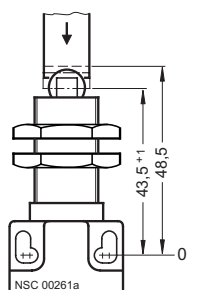

$v_{max} = 1 \text{ m/s}$

Minimum force required in direction of operation: 9 N

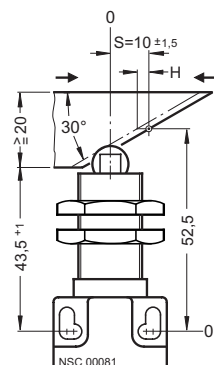

$v_{max} = 1 \text{ m/s}$

Minimum force required in direction of operation: 9 N









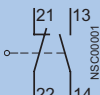

# SIGUARD Position Switches

## Standard Position Switches

Molded-plastic enclosures, 40 mm wide

### Selection and ordering data

2 contacts · Moving double break contacts · IP66 degree of protection · EN 50041

Actuator <sup>1)</sup>	Actuator design to EN 50041	Enclosure width	DT	Position switches with 2 slow-action contacts	PS*	Weight per PU approx.	DT	Position switches with 2 snap-action contacts	PS*	Weight per PU approx.	
		mm		 Ident. No. <b>11</b> acc. to EN 50013		kg		 Ident. No. <b>11</b> acc. to EN 50013		kg	
				Order No.				Order No.			
 NSC00090	<b>Rounded plunger</b>	B	40	B	→ <b>3SE2 230-0C</b>	1 unit	0.115	B	→ <b>3SE2 230-1C</b>	1 unit	0.117
 NSC 00091	<b>Roller plunger</b>	C	40	B	→ <b>3SE2 230-0D</b>	1 unit	0.120	B	→ <b>3SE2 230-1D</b>	1 unit	0.120
 NSC00092	<b>Roller lever</b>	–	40	B	→ <b>3SE2 230-0E</b>	1 unit	0.129	B	→ <b>3SE2 230-1E</b>	1 unit	0.131
 NSC00093	<b>Angular roller lever</b>	–	40	B	→ <b>3SE2 230-0F</b>	1 unit	0.135	B	→ <b>3SE2 230-1F</b>	1 unit	0.140
 NSC 00094	<b>Twist lever</b>										
	• finely adjustable from 10° to 10°	A	40	B	→ <b>3SE2 230-0GW</b>	1 unit	0.153	B	→ <b>3SE2 230-1GW</b>	1 unit	0.154
 NSC 00095	• adjustable length, finely adjustable from 10° to 10°	–	40	B	<b>3SE2 230-0U</b>	1 unit	0.160	B	<b>3SE2 230-1U</b>	1 unit	0.162
 NSC 00096	<b>Rod actuator, finely adjustable from 10° to 10°</b>	D									
	• Molded-plastic rod		40	B	<b>3SE2 230-0W</b>	1 unit	0.164	B	<b>3SE2 230-1W</b>	1 unit	0.162
 NSC 00097	• Aluminium rod		40	C	<b>3SE2 230-0V</b>	1 unit	0.172	B	<b>3SE2 230-1V</b>	1 unit	0.170
 NSC 00098	<b>Spring rod</b>		40		–			B	<b>3SE2 230-1R</b>	1 unit	0.152

For operation, operating speed and travel, see Pages 11/31 to 11/35.

→ Positive opening according to IEC 60947-5-1, Appendix K.







1) The actuator heads can be subsequently replaced with other versions (see Accessories).

# SIGUARD Position Switches

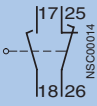
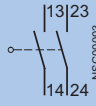
## Standard Position Switches

Molded-plastic enclosures, 40 mm wide

2 contacts · Moving double break contacts · IP66 degree of protection · EN 50041

Actuator 1)	Actuator design to EN 50041	Enclosure width	DT	Position switches with 2 slow-action make-before-break contacts	PS*	Weight per PU approx.	DT	Position switches with 2 slow-action contacts	PS*	Weight per PU approx.			
		mm		 Ident. No. <b>11</b> acc. to EN 50013 Order No.		kg		 Ident. No. <b>20</b> acc. to EN 50013 Order No.		kg			
	<b>Rounded plunger</b>	B	40	B	→	<b>3SE2 230-3C</b>	1 unit	0.115	B	→	<b>3SE2 230-7C</b>	1 unit	0.115
	<b>Roller plunger</b>	C	40	B	→	<b>3SE2 230-3D</b>	1 unit	0.117	B	→	<b>3SE2 230-7D</b>	1 unit	0.116
	<b>Roller lever</b>	–	40	B	→	<b>3SE2 230-3E</b>	1 unit	0.127	B	→	<b>3SE2 230-7E</b>	1 unit	0.130
	<b>Angular roller lever</b>	–	40	B	→	<b>3SE2 230-3F</b>	1 unit	0.115	C	→	<b>3SE2 230-7F</b>	1 unit	0.140
	<b>Twist lever</b>												
	• finely adjustable from 10° to 10°	A	40	B	→	<b>3SE2 230-3GW</b>	1 unit	0.152	B	→	<b>3SE2 230-7GW</b>	1 unit	0.147
	• adjustable length, finely adjustable from 10° to 10°	–	40		–				B		<b>3SE2 230-7U</b>	1 unit	0.350
	<b>Rod actuator,</b> finely adjustable from 10° to 10°	D											
	• Molded-plastic rod		40		–				B		<b>3SE2 230-7W</b>	1 unit	0.310
	• Aluminium rod		40		–				B		<b>3SE2 230-7V</b>	1 unit	0.320

For operation, operating speed and travel, see Pages 11/31 to 11/35.

→ Positive opening according to IEC 60947-5-1, Appendix K.







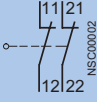
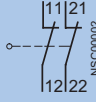

1) The actuator heads can be subsequently replaced with other versions (see Accessories).

# SIGUARD Position Switches

## Standard Position Switches

Molded-plastic enclosures, 40 mm wide

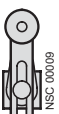
2 contacts · Moving double break contacts · IP66 degree of protection · EN 50041

Actuator 1)	Actuator design to EN 50041	Enclosure width	DT	Position switches with 2 slow-action contacts	PS*	Weight per PU approx.	DT	Position switches with 2 snap-action contacts	PS*	Weight per PU approx.	
		mm		 Ident.No. <b>02</b> acc. to EN 50013 Order No.		kg	 Ident.No. <b>02</b> acc. to EN 50013 Order No.		kg		
	<b>Rounded plunger</b>	B	40	B	→ <b>3SE2 230-6C</b>	1 unit	0.114	A	→ <b>3SE2 230-8CV00</b>	1 unit	0.130
	<b>Roller plunger</b>	C	40	B	→ <b>3SE2 230-6D</b>	1 unit	0.116	A	→ <b>3SE2 230-8DV00</b>	1 unit	0.138
	<b>Roller lever</b>	–	40	B	→ <b>3SE2 230-6E</b>	1 unit	0.125	A	→ <b>3SE2 230-8EV00</b>	1 unit	0.146
	<b>Angular roller lever</b>	–	40	B	→ <b>3SE2 230-6F</b>	1 unit	0.140	A	→ <b>3SE2 230-8FV00</b>	1 unit	0.149
	<b>Twist lever</b>			B	→ <b>3SE2 230-6GW</b>	1 unit	0.145	A	→ <b>3SE2 230-8GW00</b>	1 unit	0.176
	• finely adjustable from 10° to 10°	A	40								
	• adjustable length, finely adjustable from 10° to 10°	–	40	C	<b>3SE2 230-6U</b>	1 unit	0.160	B	<b>3SE2 230-8UV00</b>	1 unit	0.193
	<b>Rod actuator, finely adjustable from 10° to 10°</b>	D									
	• Molded-plastic rod		40	B	<b>3SE2 230-6W</b>	1 unit	0.310	B	<b>3SE2 230-8WW00</b>	1 unit	0.194
	• Aluminium rod		40	B	<b>3SE2 230-6V</b>	1 unit	0.320	B	<b>3SE2 230-8VV00</b>	1 unit	0.320
	<b>Spring rod</b>		40		–			B	<b>3SE2 230-8RV00</b>	1 unit	0.158

For operation, operating speed and travel, see Pages 11/31 to 11/35.

→ Positive opening according to IEC 60947-5-1, Appendix K.

1) The actuator heads can be subsequently replaced with other versions (see Accessories).

# SIGUARD Position Switches

## Standard Position Switches

Molded-plastic enclosures, 40 mm wide

### Accessories

The actuator heads of the position switches can be subsequently exchanged.

	Actuator with fixing screws and gasket	Can be used for position switches	DT	Order No.	PS*	Weight per PU approx. kg
	<b>Rounded plunger</b>	3SE2 230--C	▶	<b>3SX3 160</b>	1 unit	0.021
	<b>Roller plunger</b>	3SE2 230--D	▶	<b>3SX3 161</b>	1 unit	0.024
	<b>Roller lever</b>	3SE2 230--E	▶	<b>3SX3 164</b>	1 unit	0.034
	<b>Angular roller lever</b>	3SE2 230--F	B	<b>3SX3 168</b>	1 unit	0.036
	<b>Twist lever</b> • finely adjustable from 10° to 10° (supplied with plunger)	3SE2 230--GW	B	<b>3SX3 167</b>	1 unit	0.048
	• adjustable length (supplied with plunger)	3SE2 230--U	B	<b>3SX3 163</b>	1 unit	0.058
	<b>Rod actuator,</b> adjustable length • with aluminum rod	3SE2 230--V	B	<b>3SX3 165</b>	1 unit	0.069
	• with molded-plastic rod (supplied with plunger)	3SE2 230--W	B	<b>3SX3 166</b>	1 unit	0.061
	<b>Spring rod</b> <sup>1)</sup> (different lengths on request)	3SE2 230--R	B	<b>3SX3 210</b>	1 unit	0.051

1) Only for snap-action contacts.

# SIGUARD Position Switches

## Standard Position Switches

Molded-plastic enclosures, 40 mm wide

### Dimension drawings

3SE2 230, enclosure acc. to EN 50041, with rounded plunger, Type B

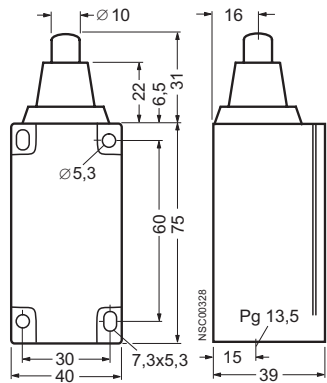

Roller plunger, Type C

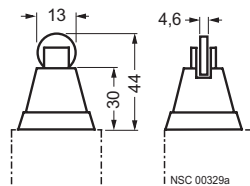

Roller lever

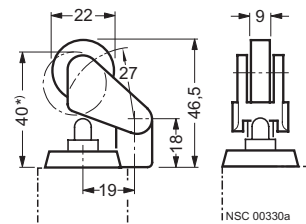

\* Lever in final position

Angular roller lever

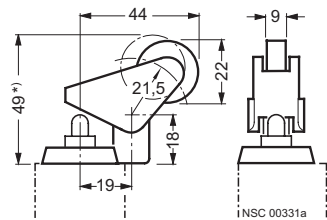

\* Lever in final position

Twist lever, Type A

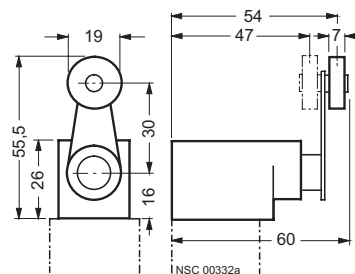

Twist lever, adjustable length

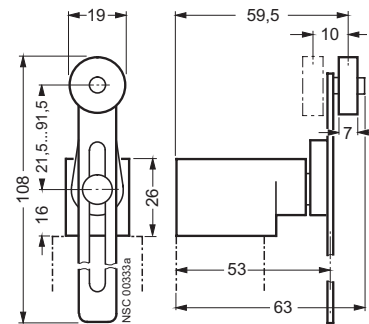

Rod actuator, Type D

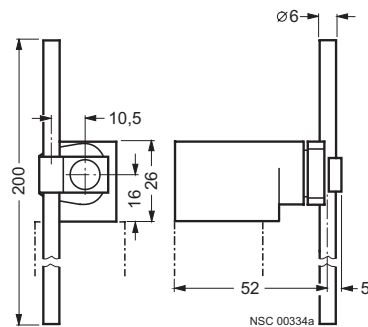

Spring rod

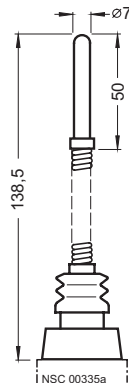













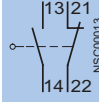

# SIGUARD Position Switches

## Standard Position Switches

Metal enclosures, 40 and 56 mm wide

### Selection and ordering data

2 contacts · Moving double-break contacts · IP67 degree of protection · EN 50041 · Special width 56 mm

Actuator <sup>1)</sup>	Actuator design to EN 50041	Enclosure width	DT	Position switches with 2 slow-action contacts	PS*	Weight per PU approx.	DT	Position switches with 2 snap-action contacts	PS*	Weight per PU approx.		
		mm		 Ident. No. 11 acc. to EN 50013				 Ident. No. 11 acc. to EN 50013				
				Order No.		kg		Order No.		kg		
 NSC00096	<b>Plunger</b>	–	40	▶ →	<b>3SE2 120-0B</b>	1 unit	0.190	▶ →	<b>3SE2 120-1B</b>	1 unit	0.192	
		–	56	B	▶ →	<b>3SE2 100-0B</b>	1 unit	0.220	B ▶ →	<b>3SE2 100-1B</b>	1 unit	0.220
 NSC00097	<b>Rounded plunger</b>	B	40	▶ →	<b>3SE2 120-0C</b>	1 unit	0.232	▶ →	<b>3SE2 120-1C</b>	1 unit	0.232	
		–	56	B	▶ →	<b>3SE2 100-0C</b>	1 unit	0.250	B ▶ →	<b>3SE2 100-1C</b>	1 unit	0.260
 NSC 00098	<b>Roller plunger</b>	C	40	▶ →	<b>3SE2 120-0D</b>	1 unit	0.251	▶ →	<b>3SE2 120-1D</b>	1 unit	0.255	
		–	56	B	▶ →	<b>3SE2 100-0D</b>	1 unit	0.280	B ▶ →	<b>3SE2 100-1D</b>	1 unit	0.279
 NSC 00099	<b>Roller lever</b>	–	40	▶ →	<b>3SE2 120-0E</b>	1 unit	0.207	▶ →	<b>3SE2 120-1E</b>	1 unit	0.210	
		Molded-plastic roller	–	56	▶ →	<b>3SE2 100-0E</b>	1 unit	0.240	B ▶ →	<b>3SE2 100-1E</b>	1 unit	0.237
 NSC00093	<b>Angular roller lever</b>	–	40	▶ →	<b>3SE2 120-0F</b>	1 unit	0.215	▶ →	<b>3SE2 120-1F</b>	1 unit	0.225	
		Molded-plastic roller	–	56	B	<b>3SE2 100-0F</b>	1 unit	0.240	B ▶ →	<b>3SE2 100-1F</b>	1 unit	0.240
 NSC 00094	<b>Twist lever</b>	• finely adjustable from 10° to 10°	A	40	▶ →	<b>3SE2 120-0GW</b>	1 unit	0.308	▶ →	<b>3SE2 120-1GW</b>	1 unit	0.306
		–	–	56	B	<b>3SE2 100-0GW</b>	1 unit	0.335	B ▶ →	<b>3SE2 100-1GW</b>	1 unit	0.331
 NSC 00095	• adjustable length, finely adjustable from 10° to 10°	–	40	B	<b>3SE2 120-0UW</b>	1 unit	0.314	▶ →	<b>3SE2 120-1UW</b>	1 unit	0.316	
		–	56	B	<b>3SE2 100-0UW</b>	1 unit	0.362	B ▶ →	<b>3SE2 100-1UW</b>	1 unit	0.336	
 NSC 00010	<b>Rod actuator, finely adjustable from 10° to 10°</b>	D										
		• Molded-plastic rod	40	B	<b>3SE2 120-0WW</b>	1 unit	0.315	B	<b>3SE2 120-1WW</b>	1 unit	0.316	
			56	B	<b>3SE2 100-0WW</b>	1 unit	0.340	B	<b>3SE2 100-1WW</b>	1 unit	0.346	
		• Aluminium rod	40	B	<b>3SE2 120-0VW</b>	1 unit	0.321	▶ →	<b>3SE2 120-1VW</b>	1 unit	0.322	
		56	B	<b>3SE2 100-0VW</b>	1 unit	0.354	B	<b>3SE2 100-1VW</b>	1 unit	0.355		
 NSC 00015	<b>Spring rod</b>	–	40	–	–			B	<b>3SE2 120-1R</b>	1 unit	0.233	
		–	56	–	–			B	<b>3SE2 100-1R</b>	1 unit	0.270	
 NSC 00101	<b>Fork lever</b>	–	40	–	–			B	<b>3SE2 120-1T</b>	1 unit	0.340	
		Latching	–	56	–	–			B	<b>3SE2 100-1T</b>	1 unit	0.330

For operation, operating speed and travel, see Pages 11/30 to 11/35.

For reusable packaging, see Appendix.

▶ → Positive opening according to IEC 60947-5-1, Appendix K.









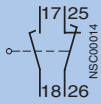

1) The actuator heads can be subsequently replaced with other versions (see Accessories, Page 11/28).

# SIGUARD Position Switches

## Standard Position Switches

Metal enclosures, 40 and 56 mm wide

2 contacts · Moving double-break contacts · IP67 degree of protection · EN 50041 · Special width 56 mm

Actuator 1)	Actuator design to EN 50041	Enclosure width	DT	Position switches with 2 slow-action make-before-break contacts	PS*	Weight per PU approx.	DT	Position switches with 2 slow-action contacts	PS*	Weight per PU approx.	
		mm		 Ident. No. <b>11</b> acc. to EN 50013 Order No.		kg		 Ident. No. <b>20</b> acc. to EN 50013 Order No.		kg	
 NSC00096	Plunger	–	40	B	→ <b>3SE2 120-3B</b>	1 unit	0.195	B	→ <b>3SE2 120-7B</b>	1 unit	0.192
		–	56	B	→ <b>3SE2 100-3B</b>	1 unit	0.222	C	→ <b>3SE2 100-7B</b>	1 unit	0.220
 NSC00097	Rounded plunger	B	40	C	→ <b>3SE2 120-3C</b>	1 unit	0.257	B	→ <b>3SE2 120-7C</b>	1 unit	0.233
		–	56	B	→ <b>3SE2 100-3C</b>	1 unit	0.251	C	→ <b>3SE2 100-7C</b>	1 unit	0.250
 NSC 00098	Roller plunger	C	40	B	→ <b>3SE2 120-3D</b>	1 unit	0.252	B	→ <b>3SE2 120-7D</b>	1 unit	0.251
		–	56	C	→ <b>3SE2 100-3D</b>	1 unit	0.252	C	→ <b>3SE2 100-7D</b>	1 unit	0.276
 NSC 00099	Roller lever	–	40	B	→ <b>3SE2 120-3E</b>	1 unit	0.209	B	→ <b>3SE2 120-7E</b>	1 unit	0.210
	Molded-plastic roller	–	56	B	→ <b>3SE2 100-3E</b>	1 unit	0.236	B	→ <b>3SE2 100-7E</b>	1 unit	0.235
 NSC00093	Angular roller lever	–	40	C	→ <b>3SE2 120-3F</b>	1 unit	0.225	C	→ <b>3SE2 120-7F</b>	1 unit	0.219
	Molded-plastic roller	–	56	B	→ <b>3SE2 100-3F</b>	1 unit	0.253	B	→ <b>3SE2 100-7F</b>	1 unit	0.236
 NSC 00094	Twist lever										
	• finely adjustable from 10° to 10°	A	40	B	→ <b>3SE2 120-3GW</b>	1 unit	0.304	B	→ <b>3SE2 120-7GW</b>	1 unit	0.307
		–	56	C	→ <b>3SE2 100-3GW</b>	1 unit	0.350	B	→ <b>3SE2 100-7GW</b>	1 unit	0.335
 NSC 00099	• adjustable length, finely adjustable from 10° to 10°	–	40	C	<b>3SE2 120-3UW</b>	1 unit	0.190	C	<b>3SE2 120-7UW</b>	1 unit	0.314
		–	56	B	<b>3SE2 100-3UW</b>	1 unit	0.336	C	<b>3SE2 100-7UW</b>	1 unit	0.350
 NSC 00010	Rod actuator, finely adjustable from 10° to 10°	D									
	• Molded-plastic rod		40	C	<b>3SE2 120-3WW</b>	1 unit	0.190	C	<b>3SE2 120-7WW</b>	1 unit	0.310
			56	B	<b>3SE2 100-3WW</b>	1 unit	0.235	B	<b>3SE2 100-7WW</b>	1 unit	0.346
	• Aluminium rod		40	C	<b>3SE2 120-3VW</b>	1 unit	0.190	B	<b>3SE2 120-7VW</b>	1 unit	0.315
			56	B	<b>3SE2 100-3VW</b>	1 unit	0.235	C	<b>3SE2 100-7VW</b>	1 unit	0.350

For operation, operating speed and travel, see Pages 11/30 to 11/35.  
For reusable packaging, see Appendix.

→ Positive opening according to IEC 60947-5-1, Appendix K.







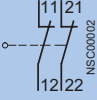
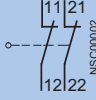

1) The actuator heads can be subsequently replaced with other versions (see Accessories, Page 11/28).

# SIGUARD Position Switches

## Standard Position Switches

Metal enclosures, 40 and 56 mm wide

2 contacts · Moving double-break contacts · IP67 degree of protection · EN 50041 · Special width 56 mm

Actuator 1)	Actuator design to EN 50041	Enclosure width	DT	Position switches with 2 slow-action contacts	PS*	Weight per PU approx.	DT	Position switches with 2 snap-action contacts	PS*	Weight per PU approx.		
		mm		 Ident.No. <b>02</b> acc. to EN 50013				 Ident.No. <b>02</b> acc. to EN 50013				
				Order No.		kg		Order No.		kg		
	<b>Plunger</b>	–	40	B	→ <b>3SE2 120-6B</b>	1 unit	0.193	A	→ <b>3SE2 120-8BV00</b>	1 unit	0.200	
		–	56	B	→ <b>3SE2 100-6B</b>	1 unit	0.218	B	→ <b>3SE2 100-8BV00</b>	1 unit	0.230	
	<b>Rounded plunger</b>	B	40	B	→ <b>3SE2 120-6C</b>	1 unit	0.232	A	→ <b>3SE2 120-8CV00</b>	1 unit	0.344	
		–	56	B	→ <b>3SE2 100-6C</b>	1 unit	0.248	B	→ <b>3SE2 100-8CV00</b>	1 unit	0.315	
	<b>Roller plunger</b>	C	40	B	→ <b>3SE2 120-6D</b>	1 unit	0.245	A	→ <b>3SE2 120-8DV00</b>	1 unit	0.359	
		–	56	B	→ <b>3SE2 100-6D</b>	1 unit	0.280	B	→ <b>3SE2 100-8DV00</b>	1 unit	0.319	
	<b>Roller lever</b>	–	40	B	→ <b>3SE2 120-6E</b>	1 unit	0.210	A	→ <b>3SE2 120-8EV00</b>	1 unit	0.370	
		Molded-plastic roller	–	56	B	→ <b>3SE2 100-6E</b>	1 unit	0.235	B	→ <b>3SE2 100-8EV00</b>	1 unit	0.323
	<b>Angular roller lever</b>	–	40	B	→ <b>3SE2 120-6F</b>	1 unit	0.220	A	→ <b>3SE2 120-8FV00</b>	1 unit	0.369	
		Molded-plastic roller	–	56	B	→ <b>3SE2 100-6F</b>	1 unit	0.240	B	→ <b>3SE2 100-8FV00</b>	1 unit	0.330
	<b>Twist lever</b>	• finely adjustable from 10° to 10°	A	40	B	→ <b>3SE2 120-6GW</b>	1 unit	0.305	A	→ <b>3SE2 120-8GW00</b>	1 unit	0.393
		–	–	56	C	→ <b>3SE2 100-6GW</b>	1 unit	0.330	B	→ <b>3SE2 100-8GW00</b>	1 unit	0.353
		• adjustable length, finely adjustable from 10° to 10°	–	40	B	<b>3SE2 120-6UW</b>	1 unit	0.308	B	<b>3SE2 120-8UW00</b>	1 unit	0.411
		–	–	56	C	<b>3SE2 100-6UW</b>	1 unit	0.350	B	<b>3SE2 100-8UW00</b>	1 unit	0.365
	<b>Rod actuator, finely adjustable from 10° to 10°</b>	D										
		• Molded-plastic rod	40	C	<b>3SE2 120-6WW</b>	1 unit	0.310	B	<b>3SE2 120-8WW00</b>	1 unit	0.421	
			56	C	<b>3SE2 100-6WW</b>	1 unit	0.340	B	<b>3SE2 100-8WW00</b>	1 unit	0.378	
		• Aluminium rod	40	C	<b>3SE2 120-6VW</b>	1 unit	0.320	B	<b>3SE2 120-8VW00</b>	1 unit	0.419	
			56	C	<b>3SE2 100-6VW</b>	1 unit	0.350	B	<b>3SE2 100-8VW00</b>	1 unit	0.384	
	<b>Spring rod</b>	–	40		–			B	<b>3SE2 120-8RV00</b>	1 unit	0.230	
			56		–			B	<b>3SE2 100-8RV00</b>	1 unit	0.250	

For operation, operating speed and travel, see Pages 11/30 to 11/35.  
For reusable packaging, see Appendix.

→ Positive opening according to IEC 60947-5-1, Appendix K.







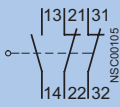
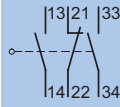

1) The actuator heads can be subsequently replaced with other versions (see Accessories, Page 11/28).

# SIGUARD Position Switches

## Standard Position Switches

Metal enclosures, 40 and 56 mm wide

3 contacts · Moving double-break contacts · Wide enclosure · Degree of protection IP67

Actuator <sup>1)</sup>	Enclosure width	DT	Position switches with 3 slow-action contacts	PS*	Weight per PU approx.	DT	Position switches with 3 snap-action contacts	PS*	Weight per PU approx.	
	mm		 Ident. No. <b>12</b> acc. to EN 50013				 Ident. No. <b>21</b> acc. to EN 50013			
			Order No.		kg		Order No.		kg	
 NSC00096	<b>Plunger</b>	56	C	→ <b>3SE2 303-0B</b>	1 unit	0.296	B	→ <b>3SE2 303-1B</b>	1 unit	0.290
 NSC00097	<b>Rounded plunger</b>	56	B	→ <b>3SE2 303-0C</b>	1 unit	0.332	B	→ <b>3SE2 303-1C</b>	1 unit	0.325
 NSC 00098	<b>Roller plunger</b>	56	B	→ <b>3SE2 303-0D</b>	1 unit	0.355	B	→ <b>3SE2 303-1D</b>	1 unit	0.356
 NSC 00099	<b>Roller lever</b> Molded-plastic roller	56	B	→ <b>3SE2 303-0E</b>	1 unit	0.312	B	→ <b>3SE2 303-1E</b>	1 unit	0.314
 NSC00093	<b>Angular roller lever</b> Molded-plastic roller	56	B	→ <b>3SE2 303-0F</b>	1 unit	0.315	B	→ <b>3SE2 303-1F</b>	1 unit	0.311
 NSC 00094	<b>Twist lever</b> • finely adjustable from 10° to 10°	56	B	→ <b>3SE2 303-0GW</b>	1 unit	0.411	B	→ <b>3SE2 303-1GW</b>	1 unit	0.411
 NSC 00095	• adjustable length, finely adjustable from 10° to 10°	56	B	<b>3SE2 303-0UW</b>	1 unit	0.414	B	<b>3SE2 303-1UW</b>	1 unit	0.415
 NSC 00099	<b>Rod actuator</b> , finely adjustable from 10° to 10°									
	• Molded-plastic rod	56	C	<b>3SE2 303-0WW</b>	1 unit	0.310	C	<b>3SE2 303-1WW</b>	1 unit	0.310
	• Aluminium rod	56	B	<b>3SE2 303-0VW</b>	1 unit	0.420	C	<b>3SE2 303-1VW</b>	1 unit	0.425

For operation, operating speed and travel, see Pages 11/36 to 11/41.

→ Positive opening according to IEC 60947-5-1, Appendix K.







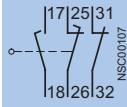
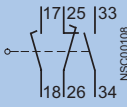

1) The actuator heads can be subsequently replaced with other versions (see Accessories, Page 11/28).

# SIGUARD Position Switches

## Standard Position Switches

Metal enclosures, 40 and 56 mm wide

3 contacts · Moving double-break contacts · Wide enclosure · Degree of protection IP67

Actuator <sup>1)</sup>	Enclosure width	DT	Position switches with 3 slow-action make before-break contacts	PS*	Weight per PU approx.	DT	Position switches with 3 snap-action make before-break contacts	PS*	Weight per PU approx.	
	mm		 Ident. No. <b>12</b> acc. to EN 50013				 Ident. No. <b>21</b> acc. to EN 50013			
			Order No.		kg		Order No.		kg	
 NSC00096	<b>Plunger</b>	56	C	→ <b>3SE2 303-2B</b>	1 unit	0.310	C	→ <b>3SE2 303-3B</b>	1 unit	0.310
 NSC00097	<b>Rounded plunger</b>	56	B	→ <b>3SE2 303-2C</b>	1 unit	0.330	B	→ <b>3SE2 303-3C</b>	1 unit	0.330
 NSC 00098	<b>Roller plunger</b>	56	B	→ <b>3SE2 303-2D</b>	1 unit	0.350	B	→ <b>3SE2 303-3D</b>	1 unit	0.350
 NSC 00099	<b>Roller lever</b> Molded-plastic roller	56	C	→ <b>3SE2 303-2E</b>	1 unit	0.330	C	→ <b>3SE2 303-3E</b>	1 unit	0.330
 NSC00093	<b>Angular roller lever</b> Molded-plastic roller	56	B	→ <b>3SE2 303-2F</b>	1 unit	0.316	C	→ <b>3SE2 303-3F</b>	1 unit	0.330
 NSC 00094	<b>Twist lever</b> • finely adjustable from 10° to 10°	56	C	→ <b>3SE2 303-2GW</b>	1 unit	0.410	B	→ <b>3SE2 303-3GW</b>	1 unit	0.411
 NSC 00095	• adjustable length, finely adjustable from 10° to 10°	56	B	<b>3SE2 303-2UW</b>	1 unit	0.310	C	<b>3SE2 303-3UW</b>	1 unit	0.310
 NSC 00010	<b>Rod actuator</b> , finely adjustable from 10° to 10° • Molded-plastic rod	56	B	<b>3SE2 303-2WW</b>	1 unit	0.310	C	<b>3SE2 303-3WW</b>	1 unit	0.310
	• Aluminium rod	56	C	<b>3SE2 303-2VW</b>	1 unit	0.310	B	<b>3SE2 303-3VW</b>	1 unit	0.310

For operation, operating speed and travel, see Pages 11/36 to 11/41.

→ Positive opening according to IEC 60947-5-1, Appendix K.









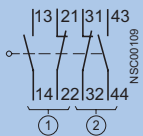
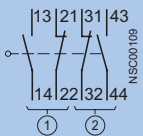

1) The actuator heads can be subsequently replaced with other versions (see Accessories, Page 11/28).

# SIGUARD Position Switches

## Standard Position Switches

Metal enclosures, 40 and 56 mm wide

4 contacts · Moving double-break contacts · Wide enclosure · Degree of protection IP67

Actuator 1)	Enclosure width	DT	Position switches with 4 slow-action contacts	PS*	Weight per PU approx.	DT	Position switches with 4 snap-action contacts	PS*	Weight per PU approx.
	mm		 Ident. No. <b>22</b> acc. to EN 50013 1) 3SE3 000 switch block 2) 3SE3 010 switch block				 Ident. No. <b>22</b> acc. to EN 50013 1) 3SE3 000 switch block 2) 3SE3 010 switch block		
			Order No.		kg		Order No.		kg
	56	B	→ <b>3SE2 404-0B</b>	1 unit	0.355	B	→ <b>3SE2 404-1B</b>	1 unit	0.353
	56	B	→ <b>3SE2 404-0C</b>	1 unit	0.395	B	→ <b>3SE2 404-1C</b>	1 unit	0.385
	56	C	→ <b>3SE2 404-0D</b>	1 unit	0.403	B	→ <b>3SE2 404-1D</b>	1 unit	0.420
	56	B	→ <b>3SE2 404-0E</b> Molded-plastic roller	1 unit	0.381	B	→ <b>3SE2 404-1E</b>	1 unit	0.380
	56	C	→ <b>3SE2 404-0F</b> Molded-plastic roller	1 unit	0.380	B	→ <b>3SE2 404-1F</b>	1 unit	0.383
	56	B	→ <b>3SE2 404-0GW</b> • finely adjustable from 10° to 10°	1 unit	0.470	B	→ <b>3SE2 404-1GW</b>	1 unit	0.469
	56	C	<b>3SE2 404-0UW</b> • adjustable length, finely adjustable from 10° to 10°	1 unit	0.477	B	<b>3SE2 404-1UW</b>	1 unit	0.479
	56	C	<b>3SE2 404-0WW</b> • Molded-plastic rod	1 unit	0.380	B	<b>3SE2 404-1WW</b>	1 unit	0.476
	56	C	<b>3SE2 404-0VW</b> • Aluminium rod	1 unit	0.490	C	<b>3SE2 404-1VW</b>	1 unit	0.488
	56		–			B	<b>3SE2 404-1T</b>	1 unit	0.465

For operation, operating speed and travel, see Pages 11/30 to 11/35.

→ Positive opening according to IEC 60947-5-1, Appendix K.

1) The actuator heads can be subsequently replaced with other versions (see Accessories, Page 11/28).









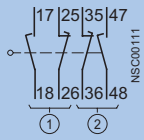

# SIGUARD Position Switches

## Standard Position Switches

Metal enclosures, 40 and 56 mm wide

4 contacts · Moving double-break contacts · Wide enclosure · Degree of protection IP67

Actuator 1)	Enclosure width	DT	Position switches with 4 slow-action contacts	PS*	Weight per PU approx.
			 <p>Ident. No. <b>22</b> acc. to EN 50013 1) 3SE3 000 switch block 2) 3SE3 010 switch block</p>		
	mm		Order No.		kg
	56	C	→ <b>3SE2 404-2B</b>	1 unit	0.380
	56	C	→ <b>3SE2 404-2C</b>	1 unit	0.400
	56	C	→ <b>3SE2 404-2D</b>	1 unit	0.420
	56	B	→ <b>3SE2 404-2E</b>	1 unit	0.380
	56	C	→ <b>3SE2 404-2F</b>	1 unit	0.400
	56	C	→ <b>3SE2 404-2GW</b>	1 unit	0.480
	56	C	<b>3SE2 404-2UW</b>	1 unit	0.380
	56	B	<b>3SE2 404-2WW</b>	1 unit	0.490
	56	C	<b>3SE2 404-2VW</b>	1 unit	0.380

For operation, operating speed and travel, see Pages 11/30 to 11/35.

→ Positive opening according to IEC 60947-5-1, Appendix K.

1) The actuator heads can be subsequently replaced with other versions (see Accessories, Page 11/28).











# SIGUARD Position Switches

## Standard Position Switches

Metal enclosures, 40 and 56 mm wide

### Accessories

The actuator heads of the position switches can be subsequently exchanged.

		Actuators with fixing screws	Can be used for position switches	DT	Order No.	PS*	Weight per PU approx. kg
		<b>Plunger</b> with screws and gasket	3SE2 ...-.B	▶	<b>3SX3 100</b>	1 unit	0.018
		<b>Rounded plunger</b> with screws and gasket	3SE2 ...-.C	▶	<b>3SX3 106</b>	1 unit	0.056
		<b>Roller plunger</b> with screws and gasket	3SE2 ...-.D	▶	<b>3SX3 107</b>	1 unit	0.076
		<b>Roller lever</b> with screws and gasket	3SE2 ...-.E	▶	<b>3SX3 102</b>	1 unit	0.034
		<b>Angular roller lever</b> with screws and gasket	3SE2 ...-.F	▶	<b>3SX3 104</b>	1 unit	0.037
		<b>Actuator head</b> • with round spindle, screws and gasket	3SE2 ...-.GW, 3SE2 ...-.UW, 3SE2 ...-.VW, 3SE2 ...-.WW	▶	<b>3SX3 211</b>	1 unit	0.112
		• for fork lever	3SE2 ...-1T	▶	<b>3SX3 127</b>	1 unit	0.131
		<b>Twist lever, 30 mm</b> for round spindle	3SE2 ...-.GW	▶	<b>3SX3 212</b>	1 unit	0.017
		<b>Fork lever</b>	3SE2 ...-1T	▶	<b>3SX3 115</b>	1 unit	0.032
		<b>Twist lever with clamp</b> adjustable length	3SE2 ...-.UW	▶	<b>3SX3 213</b>	1 unit	0.024
		<b>Roller rod</b> adjustable length (without clamp)	3SE2 ...-.UW	▶	<b>3SY3 024</b>	1 unit	0.036
		<b>Spring rod</b> with screws and gasket	3SE2 ...-1R	▶	<b>3SX3 126</b>	1 unit	0.051
		<b>Rod actuator with support</b> • Molded-plastic rod	3SE2 ...-.WW	▶	<b>3SX3 215</b>	1 unit	0.025
		• Aluminum rod	3SE2 ...-.VW	▶	<b>3SX3 214</b>	1 unit	0.032
		<b>Rod actuator (without support)</b> • Molded-plastic rod	3SE2 ...-.WW	▶	<b>3SX3 000</b>	1 unit	0.011
		• Aluminum rod	3SE2 ...-.VW	▶	<b>3SX3 001</b>	1 unit	0.016
		<b>Lampholder, complete</b> • with glow lamp, AC 230 V	3SE2 120-..	▶	<b>3SX3 135</b>	1 unit	0.003
		• with LED (green), AC/DC 24 V	3SE2 120-..	▶	<b>3SX3 136</b>	1 unit	0.007
		• with LED (green, yellow), AC/DC 24 V	3SE2 120-..	▶	<b>3SX3 232</b>	1 unit	0.005
		<b>Cover with lens, clear</b>	3SE2 120-..	B	<b>3SX3 137</b>	1 unit	0.044

11

# SIGUARD Position Switches

## Standard Position Switches

Metal enclosures, 40 and 56 mm wide

### Dimension drawings

**3SE2 120**  
narrow enclosure, 2 contacts,  
with plunger

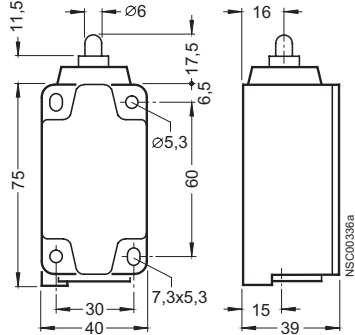

**3SE2 100**  
wide enclosure, 2 contacts,  
with plunger

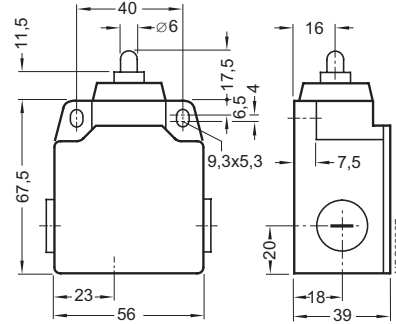

**3SE2 303**  
wide enclosure, 3 contacts

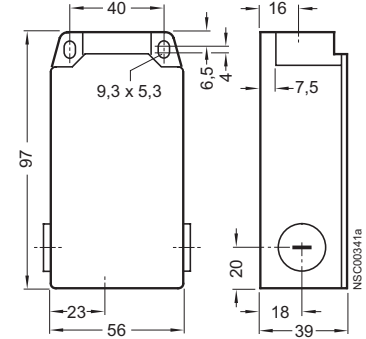

**3SE2 404**  
wide enclosure, 4 contacts

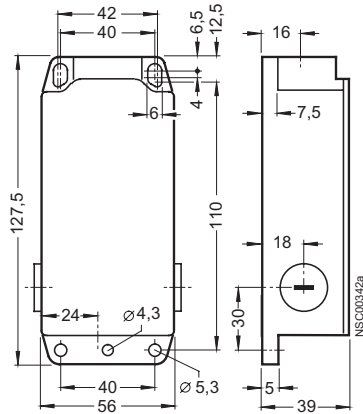

**Rounded plunger, Type B**

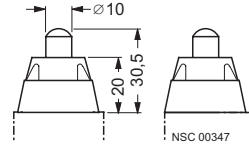

**Roller plunger, Type C**

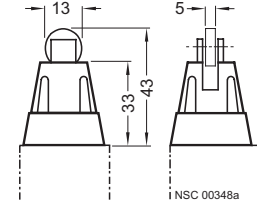

**Roller lever**

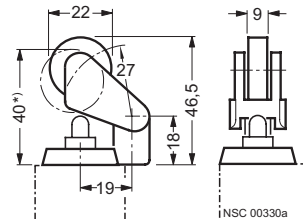

**Angular roller lever**

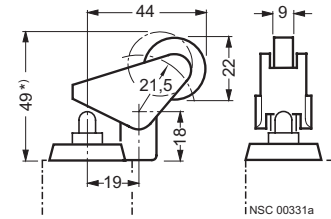

\* Lever in final position

\* Lever in final position

**Twist lever, Type A**

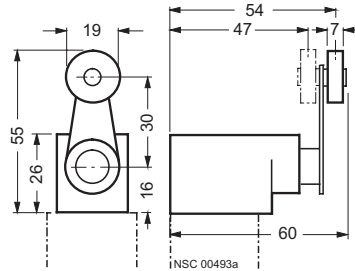

**Fork lever**

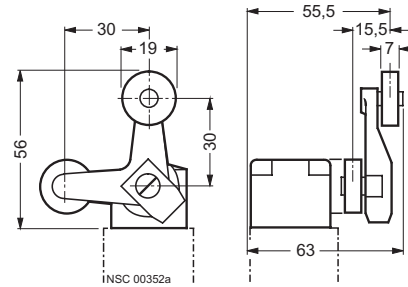

**Twist lever, adjustable length**

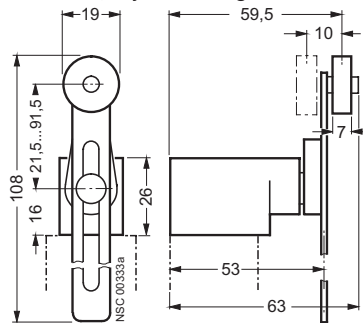

**Twist lever, adjustable length, Type D**

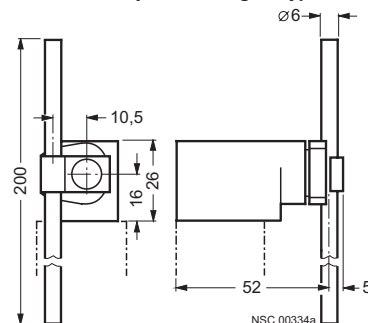

**Spring rod**

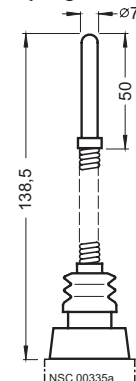

# SIGUARD Position Switches

## Standard Position Switches

Metal enclosures, 40 and 56 mm wide

### Further information



#### Operation, operating speed and travel or angle of actuators

Bars, cams, stops, etc. are used as actuating devices. The shape of the actuating device must provide the given angles for the leading and trailing edges.

#### Actuating speed in the direction of the plunger axis

The actuating speed in the case of position switches with slow-action contacts is not permitted to go lower than 15 mm/s for DC and 1 mm/s for AC. Position switches with snap-action contacts should be used when the speeds are lower.

### Position switches with 2 or 4 contacts

Operation by a bar	Switch blocks	Nominal travel	Switch blocks	Nominal travel
○ operating point acc. to EN 50041	Terminal designation acc. to EN 50013	0-line reference line acc. to EN 50041		
$v_{max}$ max. operating speed		S travel acc. to EN 50041		
0-line reference line acc. to EN 50041		 contact closed		
H travel difference		 contact open		
→ direction of operation		* operating point on return		
		** positive opening to IEC 60947-5-1		

### Plungers

3SE2 100-B,  
3SE2 120-B,  
3SE2 404-B

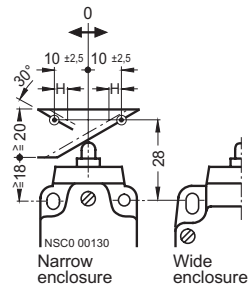
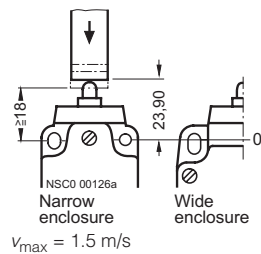

Minimum force required in direction of operation: 12 N

#### Slow-action contacts

1 NO + 1 NC

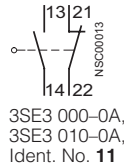

3SE3 000-0A,  
3SE3 010-0A,  
Ident. No. 11

along plunger axis lateral actuation

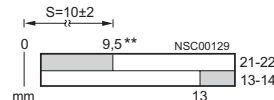
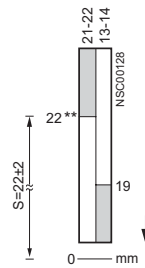

2 NC

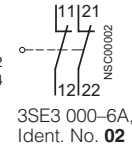

3SE3 000-6A,  
Ident. No. 02

along plunger axis

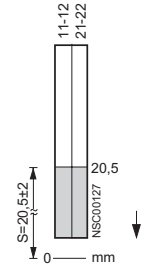

1 NO + 1 NC  
with make-before-break

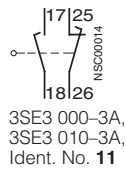

3SE3 000-3A,  
3SE3 010-3A,  
Ident. No. 11

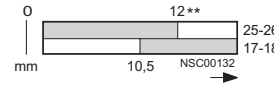
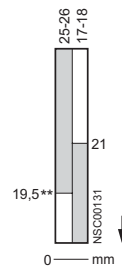

2 NO

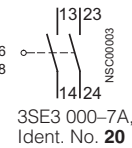

3SE3 000-7A,  
Ident. No. 20

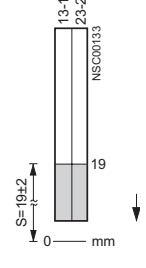

#### Snap-action contacts

1 NO + 1 NC

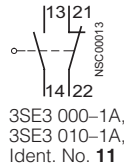

3SE3 000-1A,  
3SE3 010-1A,  
Ident. No. 11

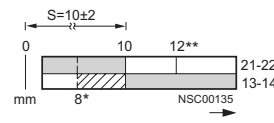
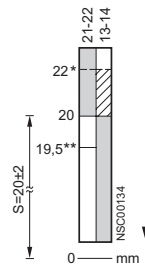



# SIGUARD Position Switches

## Standard Position Switches

Metal enclosures, 40 and 56 mm wide

### Position switches with 2 or 4 contacts

Operation by a bar		Switch blocks	Nominal travel		Switch blocks	Nominal travel
○	operating point acc. to EN 50041	Terminal designation acc. to EN 50013	0-line	reference line acc. to EN 50041		
$v_{max}$	max. operating speed		S	travel acc. to EN 50041		
0-line	reference line acc. to EN 50041			contact closed		
H	travel difference			contact open		
→	direction of operation		*	operating point on return		
			**	positive opening to IEC 60947-5-1		

### Rounded plungers, Type B

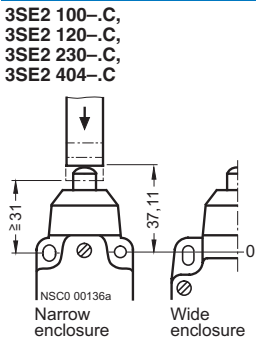

$v_{max} = 1.5 \text{ m/s}$

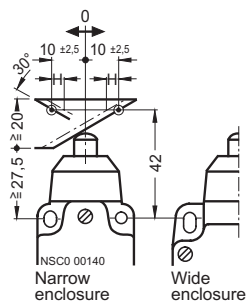

$v_{max} = 0.5 \text{ m/s}$

Minimum force required in direction of operation: 32 N

### Slow-action contacts

#### 1 NO + 1 NC

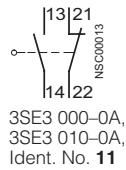

along plunger axis      lateral actuation

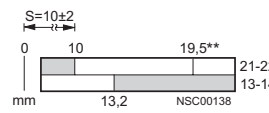
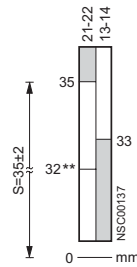

#### 2 NC

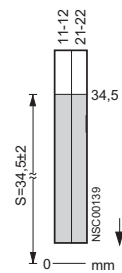
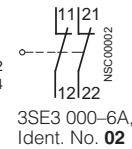

#### 1 NO + 1 NC with make-before-break

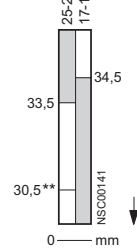
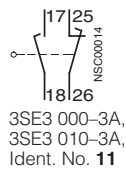

#### 2 NO

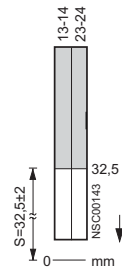
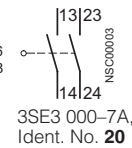

### Snap-action contacts

#### 1 NO + 1 NC

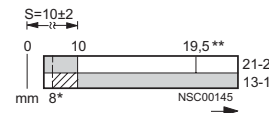
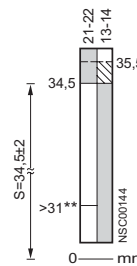
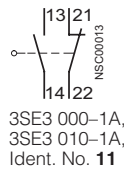

# SIGUARD Position Switches

## Standard Position Switches

### Metal enclosures, 40 and 56 mm wide

#### Position switches with 2 or 4 contacts

Operation by a bar	Switch blocks	Nominal travel	Switch blocks	Nominal travel
○ operating point acc. to EN 50041	Terminal designation acc. to EN 50013	0-line reference line acc. to EN 50041		
$v_{max}$ max. operating speed		S travel acc. to EN 50041		
0-line reference line acc. to EN 50041		■ contact closed		
H travel difference		□ contact open		
→ direction of operation		* operating point on return		
		** positive opening to IEC 60947-5-1		

#### Roller plungers, Type C

3SE2 100-D,  
3SE2 120-D,  
3SE2 230-D,  
3SE2 404-D

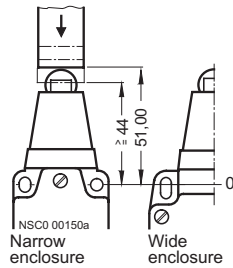

$v_{max} = 1.5 \text{ m/s}$

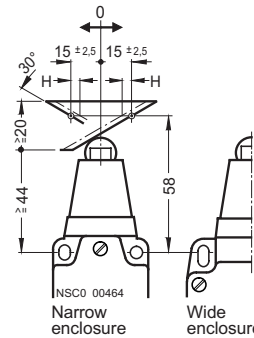

$v_{max} = 1 \text{ m/s}$  (3SE3 230-1D),  
 $v_{max} = 0.5 \text{ m/s}$  (3SE3 1.0-1D),  
Minimum force required in direction of operation: 32 N

#### Slow-action contacts

1 NO + 1 NC

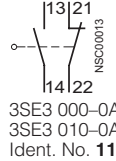

3SE3 000-0A,  
3SE3 010-0A,  
Ident. No. 11

along plunger axis lateral actuation

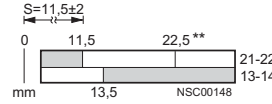
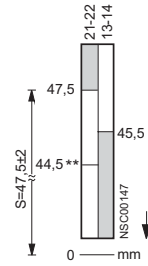

2 NC

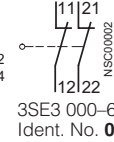

3SE3 000-6A,  
Ident. No. 02

along plunger axis

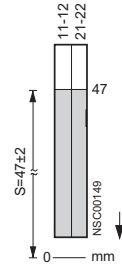

1 NO + 1 NC with make-before-break

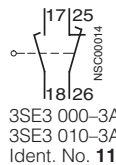

3SE3 000-3A,  
3SE3 010-3A,  
Ident. No. 11

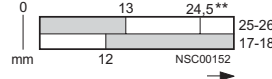
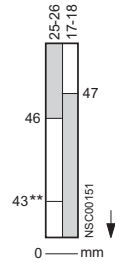

2 NO

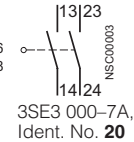

3SE3 000-7A,  
Ident. No. 20

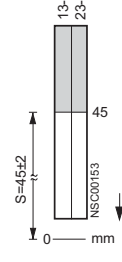

#### Snap-action contacts

1 NO + 1 NC

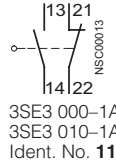

3SE3 000-1A,  
3SE3 010-1A,  
Ident. No. 11

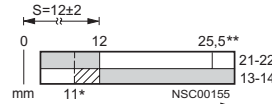
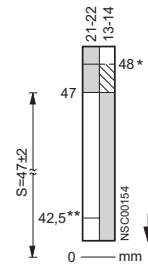

2 NO

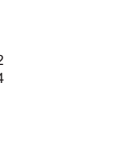

3SE3 000-7A,  
Ident. No. 20

#### Fork levers

3SE2 100-1T,  
3SE2 120-1T,  
3SE2 404-1T

Lateral actuation

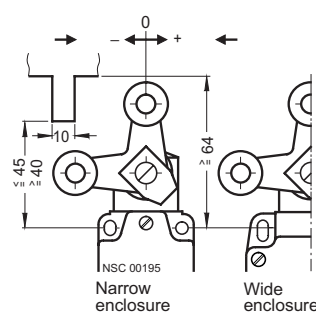

$v_{max} = 2 \text{ m/s}$

#### Snap-action contacts

1 NO + 1 NC

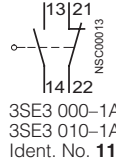

3SE3 000-1A,  
3SE3 010-1A,  
Ident. No. 11

Deflection in direction of rotation

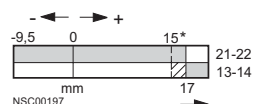
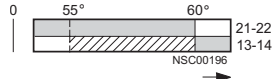

# SIGUARD Position Switches

## Standard Position Switches

Metal enclosures, 40 and 56 mm wide

### Position switches with 2 or 4 contacts

Operation by a bar	Switch blocks	Nominal travel	Switch blocks	Nominal travel
○ operating point acc. to EN 50041	Terminal designation acc. to EN 50013	0-line reference line acc. to EN 50041		
a, g approach angle		S travel acc. to EN 50041		
$v_{max}$ max. operating speed		■ contact closed		
0-line reference line acc. to EN 50041		□ contact open		
H travel difference		* operating point on return		
→ direction of operation		** positive opening to IEC 60947-5-1		

### Roller levers

3SE2 100-E, 3SE2 120-E,  
3SE2 230-E, 3SE2 404-E

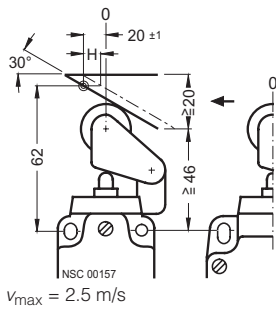

$v_{max} = 2.5 \text{ m/s}$

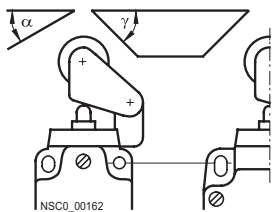

$v_{max} = 1 \text{ m/s}$ ,  $\alpha_{max} = 30^\circ$ ,  $\gamma_{max} = 45^\circ$

Minimum force required in direction of operation: 12 N

### Slow-action contacts

1 NO + 1 NC

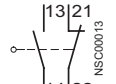

3SE3 000-0A,  
3SE3 010-0A,  
Ident. No. 11

1 NO + 1 NC  
with make-before-break

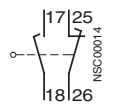

3SE3 000-3A,  
3SE3 010-3A,  
Ident. No. 11

lateral actuation

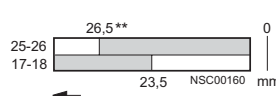
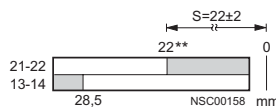

2 NC

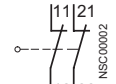

3SE3 000-6A,  
Ident. No. 02

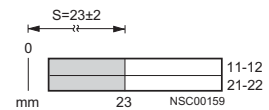

2 NO

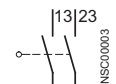

3SE3 000-7A,  
Ident. No. 20

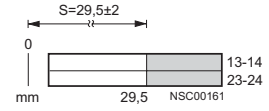

### Snap-action contacts

1 NO + 1 NC

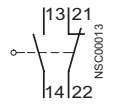

3SE3 000-1A,  
3SE3 010-1A,  
Ident. No. 11

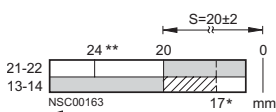

### Angular roller levers

3SE2 100-F, 3SE2 120-F,  
3SE2 230-F, 3SE2 404-F

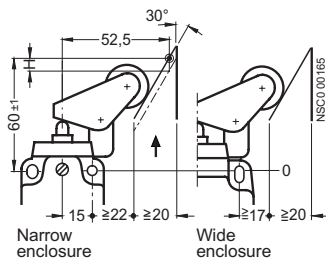

Narrow enclosure Wide enclosure

$v_{max} = 2.5 \text{ m/s}$

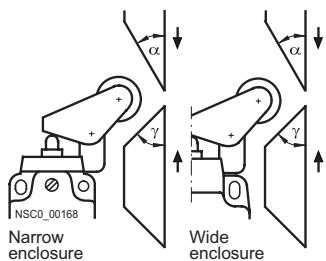

$v_{max} = 1 \text{ m/s}$ ,  $\alpha_{max} = 30^\circ$ ,  $\gamma_{max} = 45^\circ$

Minimum force required in direction of operation: 12 N

### Slow-action contacts

1 NO + 1 NC

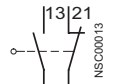

3SE3 000-0A,  
3SE3 010-0A,  
Ident. No. 11

1 NO + 1 NC  
with make-before-break

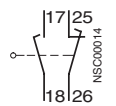

3SE3 000-3A,  
3SE3 010-3A,  
Ident. No. 11

along plunger axis

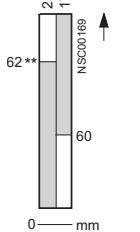
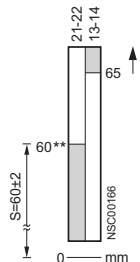

along plunger axis

2 NC

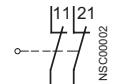

3SE3 000-6A,  
Ident. No. 02

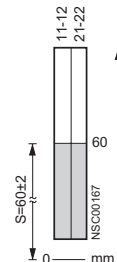

2 NO

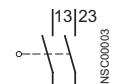

3SE3 000-7A,  
Ident. No. 20

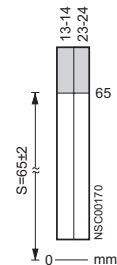

### Snap-action contacts

1 NO + 1 NC

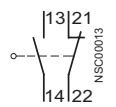

3SE3 000-1A,  
3SE3 010-1A,  
Ident. No. 11

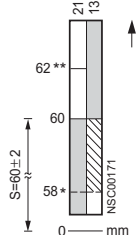

# SIGUARD Position Switches

## Standard Position Switches

Metal enclosures, 40 and 56 mm wide

### Position switches with 2 or 4 contacts

Operation by a bar	Switch blocks	Nominal travel	Switch blocks	Nominal travel
○ operating point acc. to EN 50041	Terminal designation acc. to EN 50013	0-line reference line acc. to EN 50041		
a approach angle		S travel acc. to EN 50041		
b trailing angle		■ contact closed		
$v_{max}$ max. operating speed		□ contact open		
0-line reference line acc. to EN 50041		* operating point on return		
S travel acc. to EN 50041		** positive opening acc. to IEC 60947-5-1		
H travel difference				
→ direction of operation				

### Twist levers, Type A

repositionable and finely adjustable from 10° to 10°

3SE2 100-.GW, 3SE2 120-.GW, 3SE2 230-.GW, 3SE2 404-.GW

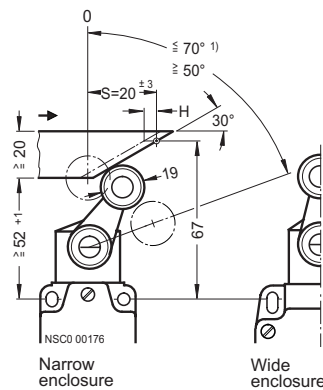

$v_{max} = 3 \text{ m/s}$

Minimum torque required in direction of operation: 25 Ncm

In special designs (Z = A31), contacts can only be operated from right or left. By twisting the plunger from the right and left.

#### Slow-action contacts

1 NO + 1 NC

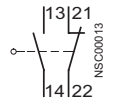

3SE3 000-0A, 3SE3 010-0A, Ident. No. 11

lateral actuation

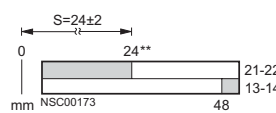

1 NO + 1 NC with make-before-break

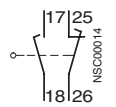

3SE3 000-3A, 3SE3 010-3A, Ident. No. 11

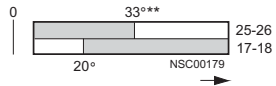
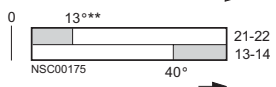

lateral actuation

2 NC

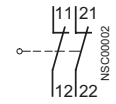

3SE3 000-6A, Ident. No. 02

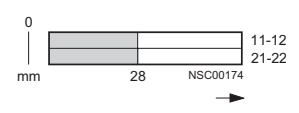

2 NO

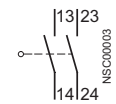

3SE3 000-7A, Ident. No. 20

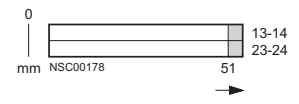

#### Snap-action contacts

1 NO + 1 NC

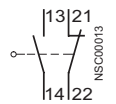

3SE3 000-1A, 3SE3 010-1A, Ident. No. 11

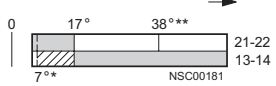
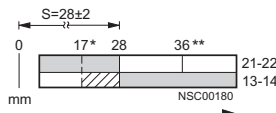

### Twist levers, adjustable length

finely adjustable from 10° to 10°

3SE2 100-.UW, 3SE2 120-.UW, 3SE2 230-.U, 3SE2 404-.UW

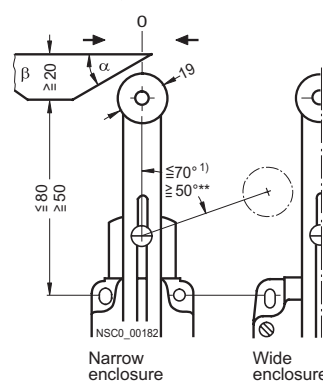

$v_{max} = 1 \text{ m/s}$ ,  $\alpha_{max} = 30^\circ$ ,  $\beta_{max} = 30^\circ$

Minimum torque required in direction of operation: 25 Ncm

Contact operation either from right or left or from right and left.

#### Slow-action contacts

1 NO + 1 NC

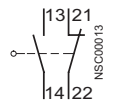

3SE3 000-0A, 3SE3 010-0A, Ident. No. 11

Deflection in direction of rotation

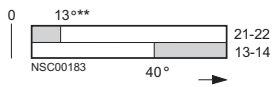

1 NO + 1 NC with make-before-break

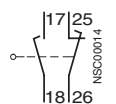

3SE3 000-3A, 3SE3 010-3A, Ident. No. 11

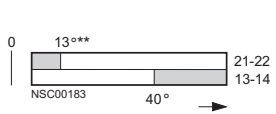

Deflection in direction of rotation

2 NC

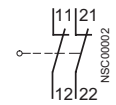

3SE3 000-6A, Ident. No. 02

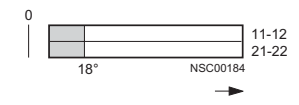

2 NO

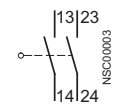

3SE3 000-7A, Ident. No. 20

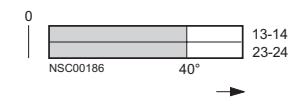

#### Snap-action contacts

1 NO + 1 NC

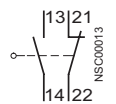

3SE3 000-1A, 3SE3 010-1A, Ident. No. 11

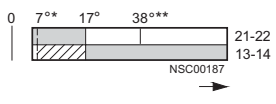

1) Max. operating angle 70°.



# SIGUARD Position Switches

## Standard Position Switches

Metal enclosures, 40 and 56 mm wide

### Position switches with 2 or 4 contacts

Operation by a bar	Switch blocks	Nominal travel	Switch blocks	Nominal travel
○ operating point acc. to EN 50041	Terminal designation acc. to EN 50013	0-line reference line acc. to EN 50041		
$v_{max}$ max. operating speed		■ contact closed		
0-line reference line acc. to EN 50041		□ contact open		
→ direction of operation		* operating point on return		
		** positive opening to IEC 60947-5-1		

### Rod actuators

finely adjustable from 10° to 10°

**3SE2 100-WW, 3SE2 120-WW, 3SE2 230-W, 3SE2 404-WW**

**3SE2 100-VW, 3SE2 120-VW, 3SE2 230-V, 3SE2 404-VW**

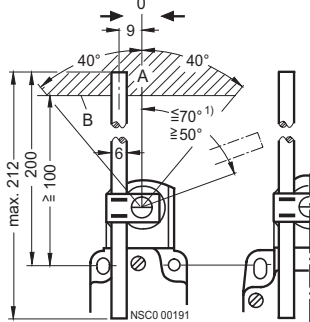

A = Operating range  
B = Lower edge of actuator

$v_{max} = 3 \text{ m/s}$

Minimum torque required in direction of operation: 25 Ncm

In special designs (Z = A31), contacts can only be operated from right or left. By twisting the plunger from the right and left.

### Slow-action contacts

#### 1 NO + 1 NC

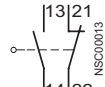

3SE3 000-0A, 3SE3 010-0A, Ident. No. 11

#### 1 NO + 1 NC with make-before-break

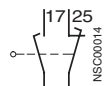

3SE3 000-3A, 3SE3 010-3A, Ident. No. 11

in direction of rotation

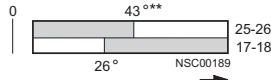
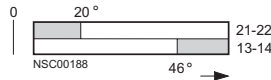

in direction of rotation

#### 2 NC

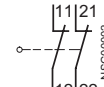

3SE3 000-6A, Ident. No. 02

#### 2 NO

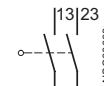

3SE3 000-7A, Ident. No. 20

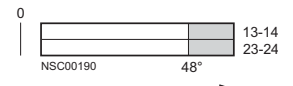
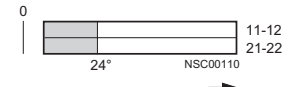

### Snap-action contacts

#### 1 NO + 1 NC

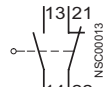

3SE3 000-1A, 3SE3 010-1A, Ident. No. 11

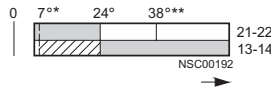

### Spring rods

**3SE2 100-1R, 3SE2 120-1R, 3SE2 230-1R**

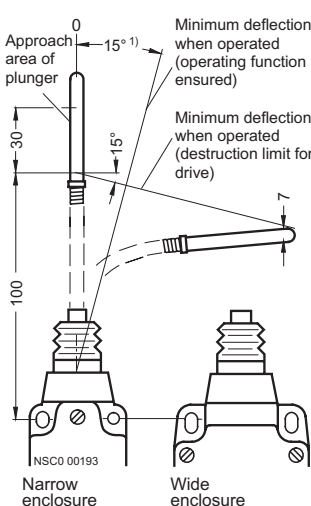

$v_{max} = 1 \text{ m/s}$ , approachable from all sides

Minimum force required in direction of operation: 12 N with lateral deflection at the tip: 2.5 N

### Snap-action contacts

#### 1 NO + 1 NC

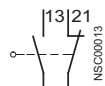

3SE3 000-1A, 3SE3 010-1A, Ident. No. 11

Deflection of spring rod

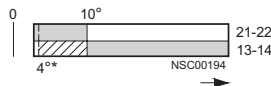

1) Max. operating angle 70°.

# SIGUARD Position Switches

## Standard Position Switches

Metal enclosures, 40 and 56 mm wide

### Position switches with 3 contacts

Operation by a bar	Switch blocks	Nominal travel	Minimum force required in direction of operation
<ul style="list-style-type: none"> <li>○ operating point acc. to EN 50041</li> <li><math>V_{max}</math> max. operating speed</li> <li>O-line reference line acc. to EN 50041</li> <li>H travel difference</li> <li>→ direction of operation</li> </ul>	Terminal designations acc. to EN 50013	<ul style="list-style-type: none"> <li>O-line reference line acc. to EN 50041</li> <li>S travel acc. to EN 50041</li> <li> contact closed</li> <li> contact open</li> <li>* operating point on return</li> <li>** positive opening to IEC 60947-5-1</li> </ul>	

Plungers	Slow-action contacts	along plunger axis	lateral actuation	
----------	----------------------	--------------------	-------------------	--

<b>3SE2 303-B</b>	<b>1 NO + 2 NC</b>			16 N
-------------------	--------------------	--	--	------

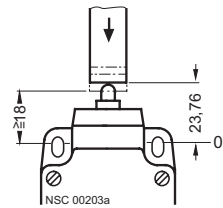

$V_{max} = 1.5 \text{ m/s}$

**Slow-action contacts**

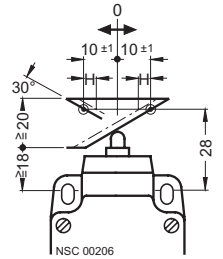
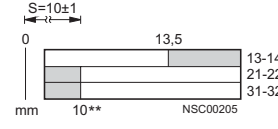
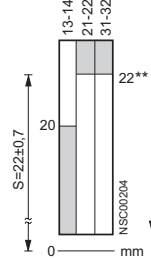
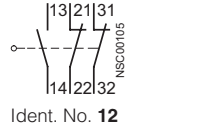

$V_{max} = 0.5 \text{ m/s}$

**2 NO + 1 NC**

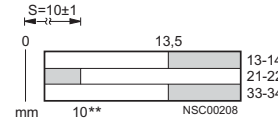
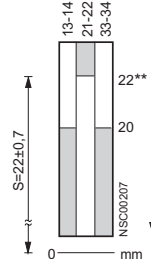
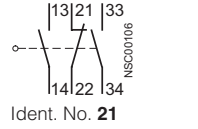

	<b>1 NO + 2 NC with make-before-break</b>			16 N
--	---	--	--	------

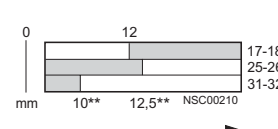
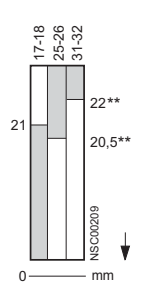
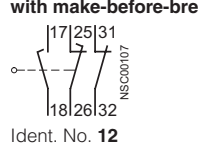

**2 NO + 1 NC with make-before-break**

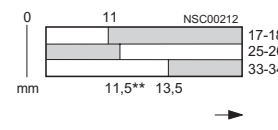
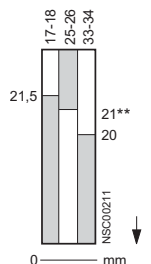
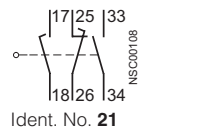

# SIGUARD Position Switches

## Standard Position Switches

Metal enclosures, 40 and 56 mm wide

### Position switches with 3 contacts

Operation by a bar	Switch blocks	Nominal travel	Minimum force required in direction of operation
<ul style="list-style-type: none"> <li>○ operating point acc. to EN 50041</li> <li><math>v_{max}</math> max. operating speed</li> <li>0-line reference line acc. to EN 50041</li> <li>H travel difference</li> <li>→ direction of operation</li> </ul>	Terminal designation acc. to EN 50013	<ul style="list-style-type: none"> <li>0-line reference line acc. to EN 50041</li> <li>S travel acc. to EN 50041</li> <li>■ contact closed</li> <li>□ contact open</li> <li>* operating point on return</li> <li>** positive opening to IEC 60947-5-1</li> </ul>	

#### Rounded plungers

##### 3SE2 303-C

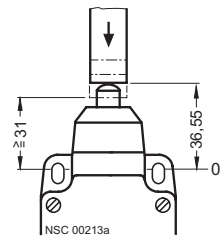

$v_{max} = 1.5 \text{ m/s}$

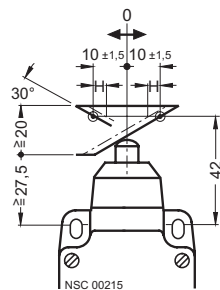

$v_{max} = 0.5 \text{ m/s}$

#### Slow-action contacts

##### 1 NO + 2 NC

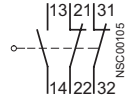

Ident. No. 12

along plunger axis

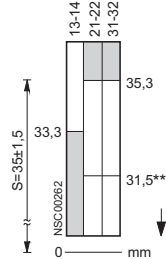

lateral actuation

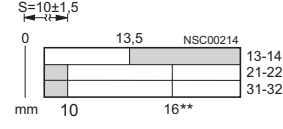

35 N

##### 2 NO + 1 NC

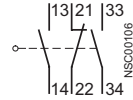

Ident. No. 21

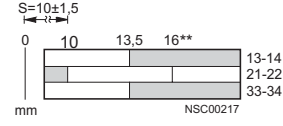
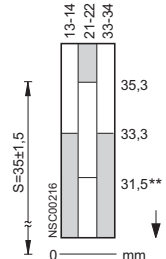

37 N

##### 1 NO + 2 NC with make-before-break

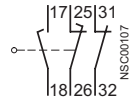

Ident. No. 12

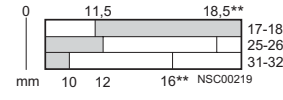
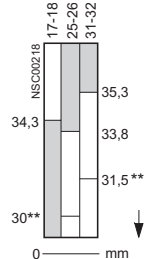

35 N

##### 2 NO + 1 NC with make-before-break

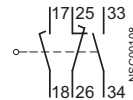

Ident. No. 21

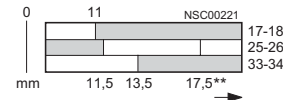
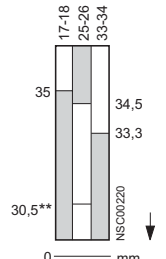

37 N

# SIGUARD Position Switches

## Standard Position Switches

Metal enclosures, 40 and 56 mm wide

### Position switches with 3 contacts

Operation by a bar	Switch blocks	Nominal travel	Minimum force required in direction of operation
<ul style="list-style-type: none"> <li>○ operating point acc. to EN 50041</li> <li><math>V_{max}</math> max. operating speed</li> <li>O-line reference line acc. to EN 50041</li> <li>H travel difference</li> <li>→ direction of operation</li> </ul>	Terminal designation acc. to EN 50013	<ul style="list-style-type: none"> <li>O-line reference line acc. to EN 50041</li> <li>S travel acc. to EN 50041</li> <li>■ contact closed</li> <li>□ contact open</li> <li>* operating point on return</li> <li>** positive opening to IEC 60947-5-1</li> </ul>	

### Roller plungers

#### 3SE2 303-D

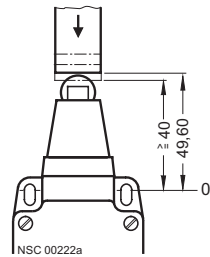

NSC 00222a  
 $V_{max} = 1.5 \text{ m/s}$

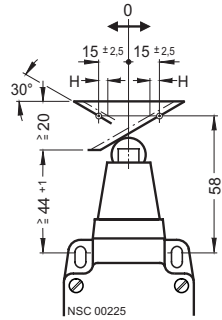

NSC 00225  
 $V_{max} = 1 \text{ m/s}$

### Slow-action contacts

#### 1 NO + 2 NC

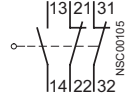

Ident. No. 12

#### 2 NO + 1 NC

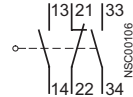

Ident. No. 21

#### 1 NO + 2 NC with make-before-break

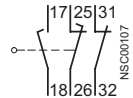

Ident. No. 12

#### 2 NO + 1 NC with make-before-break

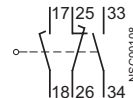

Ident. No. 21

along plunger axis

lateral actuation

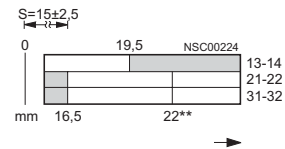
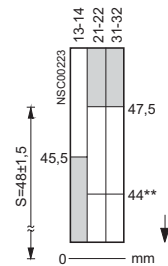

35 N

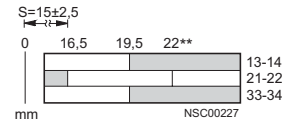
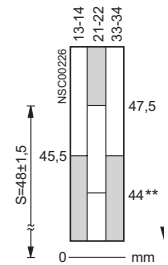

37 N

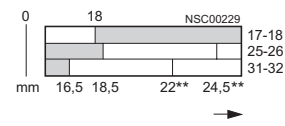
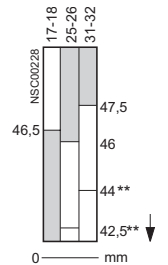

35 N

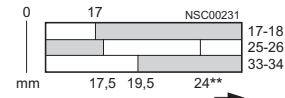
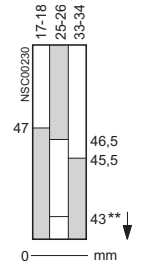

37 N

# SIGUARD Position Switches

## Standard Position Switches

Metal enclosures, 40 and 56 mm wide

### Position switches with 3 contacts

Operation by a bar	Switch blocks	Nominal travel	Minimum force required in direction of operation
○ operating point acc. to EN 50041	Terminal designation acc. to EN 50013	0-line reference line acc. to EN 50041	
a approach angle		S travel acc. to EN 50041	
b trailing angle		▒ contact closed	
g approach angle		□ contact open	
$v_{max}$ max. operating speed		** positive opening to IEC 60947-5-1	
0-line reference line acc. to EN 50041			
H travel difference			
→ direction of operation			

### Roller levers

#### 3SE2 303--E

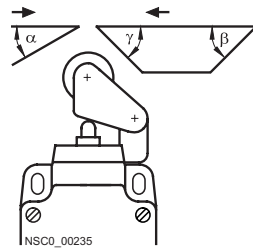
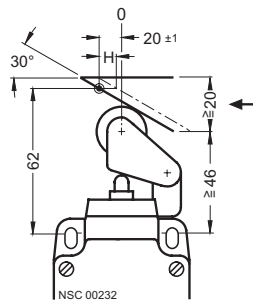

For lateral actuation:  
 $v_{max} = 1 \text{ m/s}$  at  $\alpha_{max} = 30^\circ$   
 $v_{max} = 2.5 \text{ m/s}$  at  $\gamma_{max} = 45^\circ$   
 $\beta_{max} = 45^\circ$

For operation along plunger axis:  $v_{max} = 1.5 \text{ m/s}$

### Slow-action contacts

#### 1 NO + 2 NC

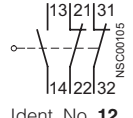

Ident. No. 12

#### 2 NO + 1 NC

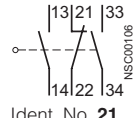

Ident. No. 21

lateral actuation

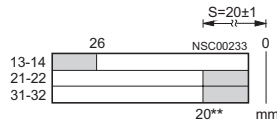

15 N

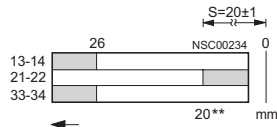

17 N

#### 1 NO + 2 NC with make-before-break

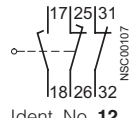

Ident. No. 12

#### 2 NO + 1 NC with make-before-break

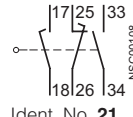

Ident. No. 21

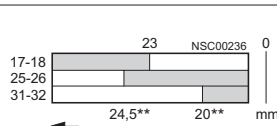

15 N

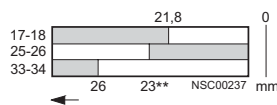

17 N

### Angular roller levers

#### 3SE2 303--F

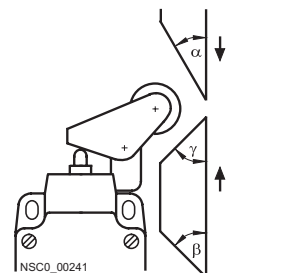
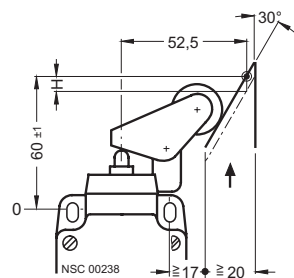

For operation along plunger axis:  
 $v_{max} = 1 \text{ m/s}$  at  $\alpha_{max} = 30^\circ$   
 $v_{max} = 2.5 \text{ m/s}$  at  $\gamma_{max} = 45^\circ$   
 $v_{max} = 2.5 \text{ m/s}$  at  $\beta_{max} = 45^\circ$

### Slow-action contacts

#### 1 NO + 2 NC

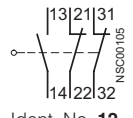

Ident. No. 12

#### 2 NO + 1 NC

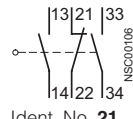

Ident. No. 21

along plunger axis

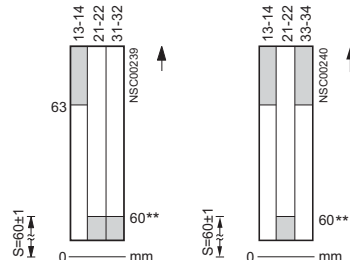

15 N

17 N

#### 1 NO + 2 NC with make-before-break

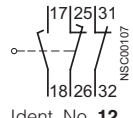

Ident. No. 12

#### 2 NO + 1 NC with make-before-break

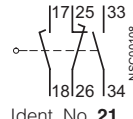

Ident. No. 21

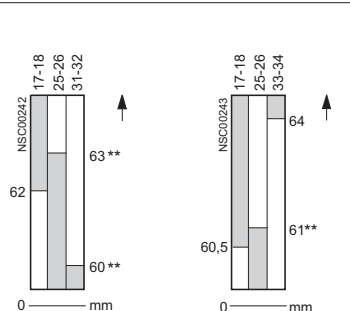

15 N

17 N

11

# SIGUARD Position Switches

## Standard Position Switches

Metal enclosures, 40 and 56 mm wide

### Position switches with 3 contacts

Operation by a bar	Switch blocks	Nominal travel	Minimum torque in direction of rotation
<ul style="list-style-type: none"> <li>○ operating point acc. to EN 50041</li> <li><math>v_{max}</math> max. operating speed</li> <li>0-line reference line acc. to EN 50041</li> <li>H travel difference</li> <li>→ direction of operation</li> </ul>	Terminal designation acc. to EN 50013	<ul style="list-style-type: none"> <li>0-line reference line acc. to EN 50041</li> <li>S travel acc. to EN 50041</li> <li>■ contact closed</li> <li>□ contact open</li> <li>** positive opening to IEC 60947-5-1</li> </ul>	

### Twist levers

finely adjustable from 10° to 10°

**3SE2 303-.GW-Z A31**

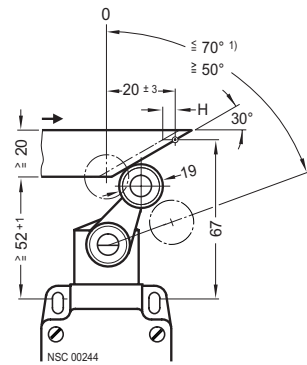

$v_{max} = 3 \text{ m/s}$

In special designs (Z = A31), contacts can only be operated from right or left. By twisting the plunger from the right and left.

### Slow-action contacts

**1 NO + 2 NC**

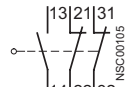

Ident. No. **12**

**2 NO + 1 NC**

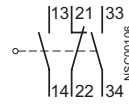

Ident. No. **21**

lateral actuation

25 Ncm

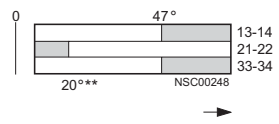
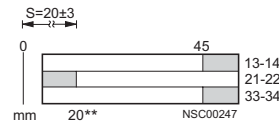
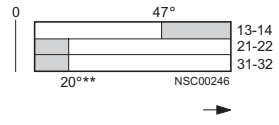
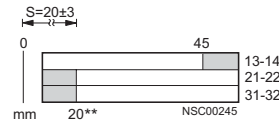

**1 NO + 2 NC with make-before-break**

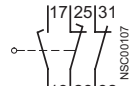

Ident. No. **12**

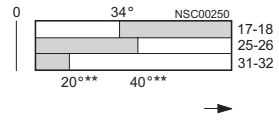
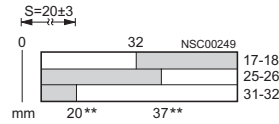

**2 NO + 1 NC with make-before-break**

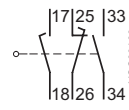

Ident. No. **21**

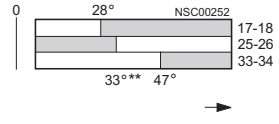
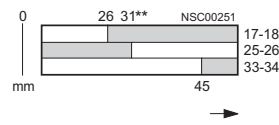

1) Max. operating angle 70°.  
Max. deflection for adjustment purposes 90°.

# SIGUARD Position Switches

## Standard Position Switches

Metal enclosures, 40 and 56 mm wide

### Position switches with 3 contacts

Operation by a bar	Switch blocks	Nominal travel	Minimum torque in direction of rotation
$\odot$ operating point acc. to EN 50041 $\alpha$ approach angle $\beta$ trailing angle $v_{max}$ max. operating speed 0-line reference line acc. to EN 50041 $\rightarrow$ direction of operation	Terminal designation acc. to EN 50013	0-line reference line acc. to EN 50041 S travel acc. to EN 50041 ■ contact closed □ contact open ** positive opening to IEC 60947-5-1	Minimum torque in direction of rotation

### Twist levers, adjustable length

finely adjustable from 10° to 10°

#### 3SE2 303-.UW

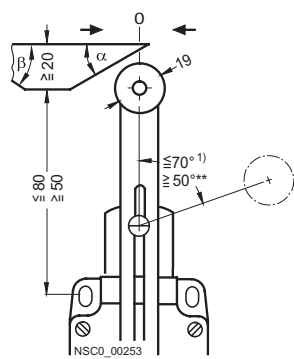

$v_{max} = 3 \text{ m/s}$ ,  
 $\alpha_{max} = 30^\circ$ ,  
 $\beta_{max} = 30^\circ$

In special designs (Z = A31), contacts can only be operated from right or left. By twisting the plunger from the right and left.

### Slow-action contacts

#### 1 NO + 2 NC

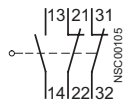

Ident. No. 12

#### 2 NO + 1 NC

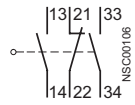

Ident. No. 21

#### 1 NO + 2 NC with make-before-break

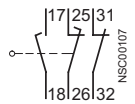

Ident. No. 12

#### 2 NO + 1 NC with make-before-break

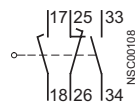

Ident. No. 21

lateral actuation

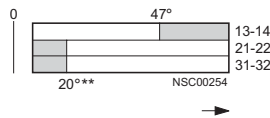

25 Ncm

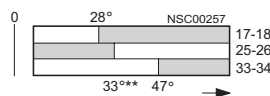
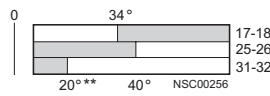
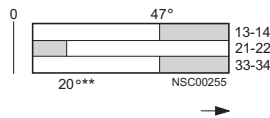

### Rod actuators

finely adjustable from 10° to 10°

#### 3SE2 303-.WW, 3SE2 303-.VW

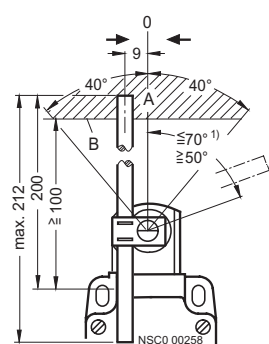

A = Operating range  
 B = Lower edge of actuator

$v_{max} = 3 \text{ m/s}$

In special designs (Z = A31), contacts can only be operated from right or left. By twisting the plunger from the right and left.

### Slow-action contacts

#### 1 NO + 2 NC

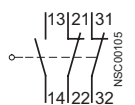

Ident. No. 12

#### 2 NO + 1 NC

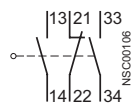

Ident. No. 21

#### 1 NO + 2 NC with make-before-break

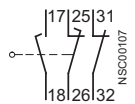

Ident. No. 12

#### 2 NO + 1 NC with make-before-break

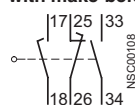

Ident. No. 21

Deflection in direction of rotation

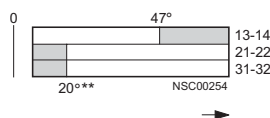

25 Ncm

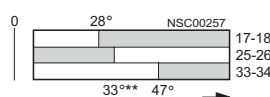
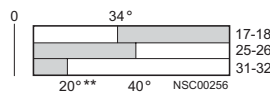
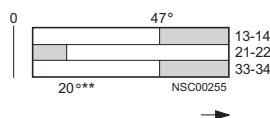

1) Max. operating angle 70°.  
Max. deflection for adjustment purposes 90°.





# SIGUARD Position Switches

## Standard Position Switches

### Position switches, open-type

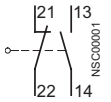
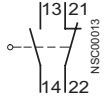
#### Selection and ordering data

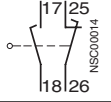
2 or 3 contacts · Moving double break contacts · Degree of protection: IP20 terminals, IP40 contact chamber

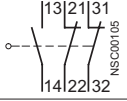
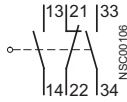
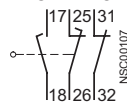
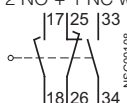
Version	Switch block	DT	Order No.	PS*	Weight per PU approx. kg	
Terminal designation acc. to EN 50013						
<b>2 contacts</b>						
	<b>Rounded plunger</b> , 21 mm long 6 mm stroke	Slow-action contacts 1 NO + 1 NC	▶ → <b>3SE3 020-0A</b>	1 unit	0.036	
			▶ → <b>3SE3 020-1A</b>	1 unit	0.036	
		Snap-action contacts 1 NO + 1 NC		▶ → <b>3SE3 020-3A</b>	1 unit	0.036
	<b>Adapter</b> for tandem arrangement (2 × 2 contacts)	Slow action contacts with 1 NO + 1 NC make-before-break	B ▶ → <b>3SE3 020-3A</b>	1 unit	0.036	
			▶ <b>3SY3 121</b>	1 unit	0.001	
<b>3 slow-action contacts</b>						
	<b>Rounded plunger</b> , 21 mm long, and repeat plunger for tandem arrangement 6 mm stroke	1 NO + 2 NC	B ▶ <b>3SE3 023-0A</b>	1 unit	0.051	
			B ▶ <b>3SE3 023-1A</b>	1 unit	0.051	
		2 NO + 1 NC		B ▶ <b>3SE3 023-2A</b>	1 unit	0.051
		1 NO + 2 NC with make-before-break		B ▶ <b>3SE3 023-3A</b>	1 unit	0.052
		2 NO + 1 NC with make-before-break				

→ Positive opening according to IEC 60947-5-1, Appendix K.



# SIGUARD Position Switches

## Standard Position Switches

Position switches, open-type

### Further information

#### Operation, operating speed and travel of actuators

Actuation	Switch blocks	Nominal travel	Minimum force required in direction of plunger axis
A	Actuating bar spacing = distance from center of the fixing hole up to lower edge of contact bar Terminal designation acc. to EN 50013	0-line ■ contact closed □ contact open * operating point on return ** positive opening acc. to IEC 60947-5-1-3	
A**	Actuating bar spacing for positive opening to IEC 60204-1 for snap-action contacts		

#### Rounded plungers

##### 3SE3 02

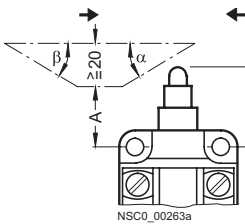

$A \geq 15$  mm;  $A^{**} \geq 17.5$  mm

Actuators can be in the form of a bar, cam, stop etc.

For lateral actuation:

$\alpha_{\max} = 30^\circ$ ;  $\beta_{\max} = 30^\circ$ ;  $v_{\max} = 0.5$  m/s

For operation along plunger axis:

$v_{\max} = 1.5$  m/s

##### 3SE3 020-A

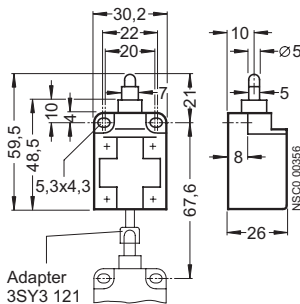

Adapter 3SY3 121

##### 3SE3 023-A

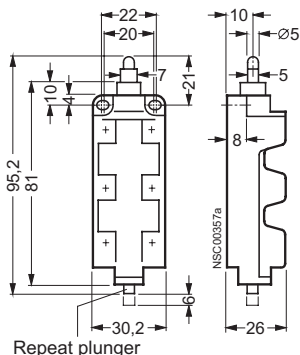

Repeat plunger

#### Slow-action contacts

1 NO + 1 NC

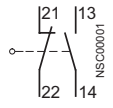

Ident. No. 11

along plunger axis

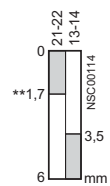

lateral actuation  $\alpha = 30^\circ$

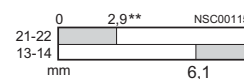

8 N

#### Snap-action contacts

1 NO + 1 NC

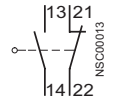

Ident. No. 11

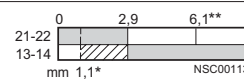
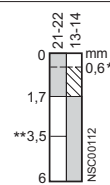

6 N

#### Slow-action contacts

1 NO + 1 NC with make-before-break

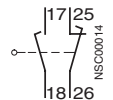

Ident. No. 11

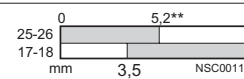
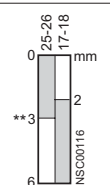

8 N

#### Slow-action contacts

1 NO + 2 NC

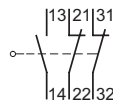

Ident. No. 12

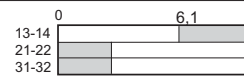
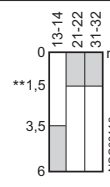

11 N

2 NO + 1 NC

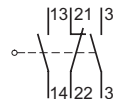

Ident. No. 21

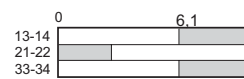
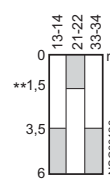

13 N

1 NO + 2 NC with make-before-break

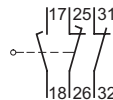

Ident. No. 12

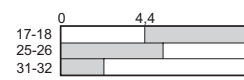
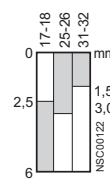

11 N

2 NO + 1 NC with make-before-break

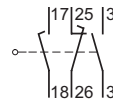

Ident. No. 21

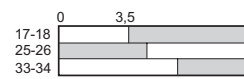
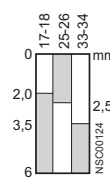

13 N

# SIGUARD Position Switches

## Standard Position Switches

### Position switches with molded cable

#### Overview

In harsh industrial environments and in installations with limited space, the small 3SE3 160 and 3SE3 180 compact switches are ideal. The switches are already equipped with a molded cable of 2 m in length and can therefore be installed in the smallest spaces.

Both the enclosure and the actuator head are made of metal and comply with the high IP67 degree of protection. The roller plunger, rounded plunger and roller lever are available as actuator heads.

The switch block is designed with snap-action contacts 1 NO + 1 NC. The NC contact complies with the requirements for positive opening according to EN 60947-5-1.

The 3SE3 1 position switch with molded cable is available in different sizes:

- The 3SE3 180 series complies with the EU standard and features a 30 mm wide enclosure with drilled holes at a spacing of 20 mm.
- The 3SE3 160 series meets the requirements of the US market and features a 40 mm wide enclosure with drilled holes at a spacing of 25 mm.

#### Technical specifications

Switching frequency	30 operating cycles/min	Degree of protection	IP67
Rated insulation voltage $U_i$	500 V	Ambient temperature	-30 ... +85 °C
Pollution degree	Class 3	Operating speed up to 80% operating distance	<ul style="list-style-type: none"> <li>• 3SE3 1.0-.C. ≤ 1 m/s</li> <li>• 3SE3 1.0-.D. Vertical ≤ 1 m/s</li> <li>Lateral ≤ 0.5 m/s</li> <li>• 3SE3 1.0-.G. ≤ 1.5 m/s</li> </ul>
Continuous thermal current $I_{th}$	10 A		
Mechanical endurance	$10 \times 10^6$ operations		
Electrical endurance	500 000 operations		
Contact opening	$2 \times 1.25$ mm		
Connecting cable (2 m)	PVC-5 x 0.75 mm <sup>2</sup> (18 AWG); br-bl: NO, bk-bk: NC, ye/gy: 0 V		

#### Selection and ordering data

##### 2 contacts · IP67 degree of protection

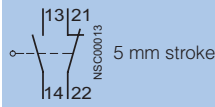
Actuator	Enclosure width	DT	Position switches with 2 snap-action contacts	PS*	Weight per PU approx.
			 <p>Ident. No. <b>11</b> acc. to EN 50013</p> <p>Order No.</p>		kg
<b>Rounded plunger</b> <ul style="list-style-type: none"> <li>• with M 12 connecting thread</li> </ul>	30	A	→ <b>3SE3 180-1C</b>	1 unit	0.316
	40	A	→ <b>3SE3 160-1C</b>	1 unit	0.332
	30	A	→ <b>3SE3 180-1CJ</b>	1 unit	0.335
	40	A	→ <b>3SE3 160-1CJ</b>	1 unit	0.351
<b>Roller plunger</b> <ul style="list-style-type: none"> <li>• with M 12 connecting thread</li> </ul>	30	A	→ <b>3SE3 180-1D</b>	1 unit	0.323
	40	A	→ <b>3SE3 160-1D</b>	1 unit	0.348
	30	A	→ <b>3SE3 180-1DJ</b>	1 unit	0.343
	40	A	→ <b>3SE3 160-1DJ</b>	1 unit	0.364
<b>Twist lever</b>	30	A	→ <b>3SE3 180-1G</b>	1 unit	0.376
	40	A	→ <b>3SE3 160-1G</b>	1 unit	0.395

→ Positive opening according to IEC 60947-5-1, Appendix K.

# SIGUARD Position Switches

## Standard Position Switches

Position switches with molded cable

### Dimension drawings

3SE3 180-1C

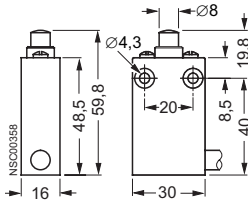

3SE3 160-1C

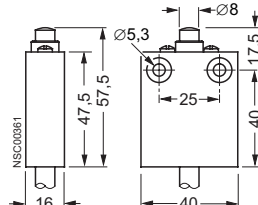

3SE3 180-1CJ

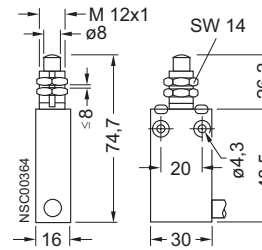

3SE3 160-1CJ

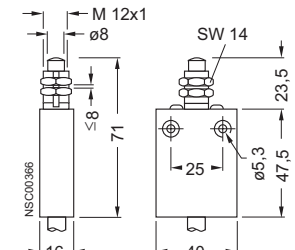

3SE3 180-1D

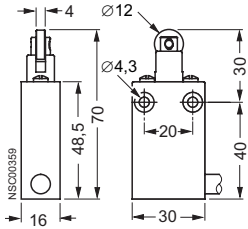

3SE3 160-1D

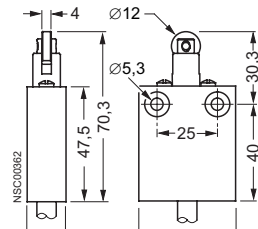

3SE3 180-1DJ

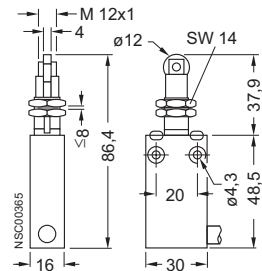

3SE3 160-1DJ

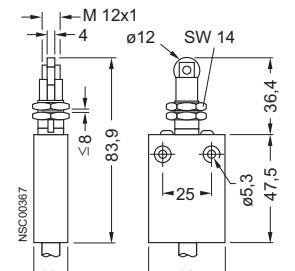

3SE3 180-1G

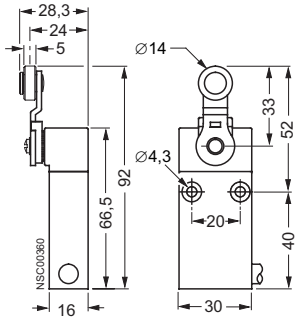

3SE3 160-1G

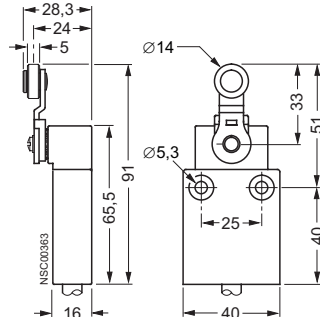

All devices complete with cable, 2 m long

11

### Further information

#### Travel

#### Switch block

Terminal designations acc. to EN 50013

Snap-action contacts 1 NO + 1 NC

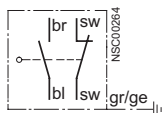

#### Nominal travel

0-line reference line acc. to EN 50041

\*\* positive opening to IEC 60947-5-1

3SE3 1.0-1C., -1D.

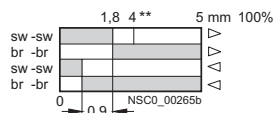

■ contact closed

□ contact open

3SE3 1.0-1G

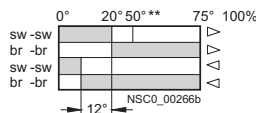













# SIGUARD Position Switches

## Standard Position Switches

### Accessories and spare parts

#### Selection and ordering data

The quick-release devices and plug connectors are used for fast installation and replacement of position switches.





		Version	DT	Order No.	PS*	Weight per PU approx. kg
<b>Quick-release devices for 3SE2 120 and 3SE2 230 position switches</b>						
3SY3 110	3SY3 027	<b>Adapter plate with screws</b> <b>Base plate with locking lever</b>	▶	<b>3SY3 110</b>	1 unit	0.054
			▶	<b>3SY3 027</b>	1 unit	0.079
						
<b>Plug connectors for all 3SE2 position switches</b>						
3SY3 131	3SY3 123	<b>Connector socket (6-pole + PE/ground), for M 20 × 1.5</b> for max. 250 V, 10 A with 0.75 mm <sup>2</sup> connecting lead, for 3SY3 123 cable plug, molded plastic, IP65 degree of protection <b>Cable plug <sup>1)</sup></b> Molded plastic, IP65 degree of protection	A	<b>3SY3 131</b>	1 unit	0.060
			B	<b>3SY3 123</b>	1 unit	0.062
3SY3 128	3RX1 505, 3RX1 584	<b>Connector socket (4-pole), M 12 for M 20 × 1.5, fixed</b> for max 250 V, 4 A with 0.75 mm <sup>2</sup> connecting lead, for 3RX1 505 coupling plug, molded plastic, IP67 degree of protection <b>Coupling plug (4-pole), M 12</b> with terminal compartment, can be pre-assembled <b>Socket (5-pole), M 12 for M 20 × 1.5, fixed</b> for max 125 V, 4 A with 0.75 mm <sup>2</sup> connecting lead, molded plastic, IP67 degree of protection <b>Coupling plug (5-pole), M 12</b> with terminal compartment, can be pre-assembled	B	<b>3SY3 127</b>	1 unit	0.020
			A	<b>3RX1 505</b>	1 unit	0.015
			B	<b>3SY3 128</b>	1 unit	0.020
			A	<b>3RX1 584</b>	1 unit	0.016
<b>Adapters and cable glands for 3SE2 position switches</b>						
3SX9 910	3SY3 124	<b>Adapter acc. to ,  and </b> , for cable entry from M 20 × 1.5 to NPT 1/2 • Metal • Molded plastic	A	<b>3SX9 917</b>	1 unit	0.100
			A	<b>3SX9 918</b>	1 unit	0.010
			B	<b>3SB39 01-0CK</b>	1 unit	0.011
<b>Adapters for 3SE3 position switches</b>						
3SX9 915		<b>Adapters</b> for cable entry from Pg 13.5 to M 20 × 1.5 • Metal • Molded plastic	A	<b>3SX9 915</b>	1 unit	0.022
			A	<b>3SX9 916</b>	1 unit	0.004

1) For wiring, a crimping tool is necessary, max. conductor size 1 mm<sup>2</sup>.

# SIGUARD Position Switches

## Standard Position Switches

### Accessories and spare parts

Version	Fig.	For position switches	DT	Order No.	PS*	Weight per PU approx. kg	
<b>Spare parts for 3SE2 100, 3SE2 120, 3SE2 230 and 3SE2 404</b>							
1	2	<b>Switch blocks with 2 contacts with moving double-break contacts</b> (2nd block for position switches with 4 contacts)					
							
		• with snap-action contacts					
		- 1 NO + 1 NC	1	3SE2 100-1., 3SE2 120-1., 3SE2 230-1., 3SE2 404-1.	B	<b>3SE3 000-1A</b>	1 unit 0.031
		- 2 NC		3SE2 100-8., 3SE2 120-8., 3SE2 230-8.	B	<b>3SE3 000-8AV00</b>	1 unit 0.030
		• with slow-action contacts					
		- 1 NO + 1 NC	2	3SE2 100-0., 3SE2 120-0., 3SE2 230-0., 3SE2 404-0.	B	<b>3SE3 000-0A</b>	1 unit 0.031
		- 2 NC		3SE2 100-6., 3SE2 120-6., 3SE2 230-6.	B	<b>3SE3 000-6A</b>	1 unit 0.029
		- 2 NO		3SE2 100-7., 3SE2 120-7., 3SE2 230-7.	B	<b>3SE3 000-7A</b>	1 unit 0.029
		• with slow-action make-before-break contacts					
		- 1 NO + 1 NC	2	3SE2 100-3., 3SE2 120-3., 3SE2 230-3., 3SE2 404-2.	B	<b>3SE3 000-3A</b>	1 unit 0.031
3	4	<b>Switch blocks with repeat plunger with 2 contacts</b> (1st block for position switches with 4 contacts)					
							
		• with snap-action contacts	3	3SE2 404-1.	B	<b>3SE3 010-1A</b>	1 unit 0.033
		1 NO + 1 NC					
		• with slow-action contacts	4	3SE2 404-0.	B	<b>3SE3 010-0A</b>	1 unit 0.032
		1 NO + 1 NC					
		• with slow-action make-before-break contacts	4	3SE2 404-2.	B	<b>3SE3 010-3A</b>	1 unit 0.034
		1 NO + 1 NC					
<b>Spare parts for 3SE2 303</b>							
5		<b>Switch blocks with 3 contacts with moving double-break contacts</b>					
							
		• with slow-action contacts					
		- 1 NO + 2 NC	5	3SE2 303-0.	B	<b>3SE3 003-0A</b>	1 unit 0.047
		- 2 NO + 1 NC	5	3SE2 303-1.	B	<b>3SE3 003-1A</b>	1 unit 0.047
		• with slow-action make-before-break contacts					
		- 1 NO + 2 NC	5	3SE2 303-2.	B	<b>3SE3 003-2A</b>	1 unit 0.048
		- 2 NO + 1 NC	5	3SE2 303-3.	B	<b>3SE3 003-3A</b>	1 unit 0.050

\* This quantity or a multiple thereof can be ordered

# SIGUARD Position Switches

## Position Switches with Separate Actuator

### General data

#### Overview



#### Area of application

SIGUARD position switches with separate actuator are used where the position of doors, covers or safety screens must be monitored for safety reasons. For example, they are used in safety circuits together with 3TK28 safety combinations, up to Category 4.

#### Approvals

The 3SE2 200 molded-plastic enclosed position switches and the 3SE2 120 metal-enclosed position switches have been given an approval test certificate from the BIA (Berufsgenossenschaftliches Institut für Arbeitssicherheit) and the Schweizer Unfallversicherungsanstalt (SUVA).

#### Design

These compact SIGUARD position switches are available in three versions:

- With molded-plastic enclosure and fixing dimensions acc. to EN 50047,
- With metal enclosure and fixing dimensions acc. to EN 50041
- With molded-plastic enclosure outside of the standards that has arisen in this form in accordance with general market requirements.

When used as a safety position switch, mounting at a spacing of 20 mm (molded-plastic enclosure) or 30 mm (metal enclosure) is necessary. Or the switch must be fitted with a pin or with a stop.

#### Actuation

The position switch can only be operated with the matching triple-coded actuator. Simple overruling by hand or auxiliary devices is impossible.

The actuators are not included in the scope of supply of the switch and must be ordered separately.

The actuator with lateral actuation can be adjusted through  $4 \times 90^\circ$ . It cannot be replaced with actuators of the standard type.

The actuator heads of the 3SE2 243 and 3SE2 257 switches with special enclosures cannot be changed.

#### Radius actuator

The position switches with radius actuators are particularly suitable for rotatable protection devices. The movable actuation key allows even small radii to be approached. Damage to the switch and the actuator due to inaccurate approach is prevented.

#### → Positive opening

The switch can be used in safety circuits due to the positive opening of the NC and positive closing of the NO contacts by pulling the actuator. A position switch must not be used as an end stop.

#### Contact reliability

The movable contacts of the 3SE2 120 and 3SE2 200 switches are designed as double-break contacts. This ensures an extremely high contact stability, even when the devices are switching low voltages and currents, e.g. DC 5 V/1 mA.

# SIGUARD Position Switches

## Position Switches with Separate Actuator

General data

### Technical specifications

Type	3SE2 1, 3SE2 2	
<b>Standards</b>	IEC 60947-5-1, EN 60947-5-1	
<b>Rated insulation voltage <math>U_i</math></b>	V	500
<b>Pollution degree</b> acc. to EN 60664	Class 3	
<b>Rated operating voltage <math>U_e</math></b>	V	AC 500; over AC 380 V only for equal potential
<b>Continuous thermal current <math>I_{th}</math></b>	A	10
<b>Rated operating current <math>I_e</math></b>		
<ul style="list-style-type: none"> <li>For alternating current 40 ... 60 Hz</li> <li>- at 24 V</li> <li>- at 125 V</li> <li>- at 230 V</li> <li>- at 400 V</li> <li>- at 500 V</li> </ul>	$I_e$ / AC-12 A 10 10 10 10 10	$I_e$ / AC-15 10 10 6 4 3
<ul style="list-style-type: none"> <li>For direct current</li> <li>- at 24 V</li> <li>- at 48 V</li> <li>- at 110 V</li> <li>- at 220 V</li> <li>- at 440 V</li> </ul>	$I_e$ / DC-12 A 10 6 4 1 0.5	$I_e$ / DC-13 10 4 1 0.4 0.2
<b>Short circuit protection<sup>1)</sup></b> , DIAZED fuse links		
<ul style="list-style-type: none"> <li>Operational class gL/gG</li> <li>Quick response characteristic</li> </ul>	A	6 10
<b>Mechanical endurance</b>	> $1 \times 10^6$ operating cycles	
<b>Electrical endurance</b>		
<ul style="list-style-type: none"> <li>With 3RH11, 3RT10 16 to 3RT10 26 contactors</li> <li>For AC-15 duty</li> <li>For DC-13 duty</li> </ul>	> $1 \times 10^6$ operating cycles  $0.5 \times 10^6$ operating cycles when interrupting $I_e$ / AC-15 at 230 V  With DC the contact endurance depends not only on the breaking current but also on the voltage, the circuit inductance and the speed of switching. No generally valid information can be given.	
<b>Operating frequency</b> with 3RH11, 3RT10 16 to 3RT10 26 contactors	$6 \times 10^3$ operating cycles/h	

Type	3SE2 200	3SE2 243, 3SE2 257	3SE2 120
<b>Enclosure</b>	Fiber-glass strengthened thermoplastic		Aluminum (GD - AlSi 12)
<b>Degree of protection</b> acc. to IEC 60529	IP65	IP67	IP67
<b>Ambient temperature</b>			
<ul style="list-style-type: none"> <li>in operation</li> <li>for storage, transport</li> </ul>	-30 ... +85 °C		-35 ... +85 °C
<b>Mounting position</b>	Any		
<b>Cable entry</b>	1 × (M 20 × 1.5)		1 × (M 20 × 1.5)
<b>Conductor cross-sections</b>			
<ul style="list-style-type: none"> <li>Solid</li> <li>Finely stranded with end sleeve</li> </ul>	2 × 2.5 mm <sup>2</sup>  2 × 1.5 mm <sup>2</sup>	1 × (0.5 ... 1.5 mm <sup>2</sup> ), 2 × (0.5 ... 1 mm <sup>2</sup> )  1 × (0.5 ... 1.5 mm <sup>2</sup> ), 2 × (0.5 ... 1 mm <sup>2</sup> )	2 × 2.5 mm <sup>2</sup>  2 × 1.5 mm <sup>2</sup>
<b>Protective conductor terminal</b> inside enclosure	-		M 3.5

1) Without any welds according to IEC 60947-5-1.

11



# SIGUARD Position Switches

## Position Switches with Separate Actuator

Molded-plastic enclosures, 31 mm wide

### Selection and ordering data

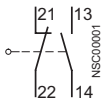
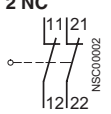
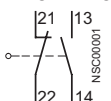
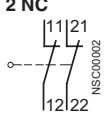
2 contacts · Moving double break contacts · IP65 degree of protection

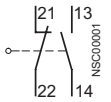
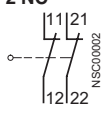
	Actuation/Fixing	Enclosure width/ actuator length mm	Slow-action contacts/ Ident. No. acc. to EN 50013	DT	Order No.	PS*	Weight per PU approx. kg
<b>Molded-plastic enclosures acc. to EN 50047</b>							
	<b>Lateral actuation</b> <sup>1)</sup>		6 mm stroke				
	• with M 20 × 1.5 connecting thread	31	<b>1 NO + 1 NC</b>  Ident. No. <b>11</b>	B	→ <b>3SE2 200-0XX03</b>	1 unit	0.084
	• with M 20 × 1.5 connecting thread	31	<b>2 NC</b>  Ident. No. <b>02</b>	B	→ <b>3SE2 200-6XX03</b>	1 unit	0.084
	<b>Front-end actuation</b> <sup>1)</sup>		6 mm stroke				
• with M 20 × 1.5 connecting thread	31	<b>1 NO + 1 NC</b>  Ident. No. <b>11</b>	B	→ <b>3SE2 200-0XX04</b>	1 unit	0.098	
• with M 20 × 1.5 connecting thread	31	<b>2 NC</b>  Ident. No. <b>02</b>	B	→ <b>3SE2 200-6XX04</b>	1 unit	0.097	
	<b>Actuators</b>						
	• Standard	50		B	<b>3SX3 196</b>	1 unit	0.011
	• Standard	70		B	<b>3SX3 195</b>	1 unit	0.012
	<b>5 directions of approach</b> <sup>1)</sup>		6 mm stroke				
	• with Pg 13.5 connecting thread	31	<b>1 NO + 1 NC</b>  Ident. No. <b>11</b>	B	→ <b>3SE3 200-0XX13</b>	1 unit	0.108
	• with Pg 13.5 connecting thread	31	<b>2 NC</b>  Ident. No. <b>02</b>	B	→ <b>3SE3 200-6XX13</b>	1 unit	0.109
	<b>Actuators</b>						
	• Standard	44		A	<b>3SX3 220</b>	1 unit	0.012
	• With transverse fixing	36		A	<b>3SX3 221</b>	1 unit	0.012
	• Universal radius actuator	44		B	<b>3SX3 254</b>	1 unit	0.017

→ Positive opening according to IEC 60947-5-1, Appendix K.

1) Supplied without actuator.



# SIGUARD Position Switches

## Position Switches with Separate Actuator

Molded-plastic enclosures, 31 mm wide

### Dimension drawings

**3SE2 200-XX03, lateral actuation**

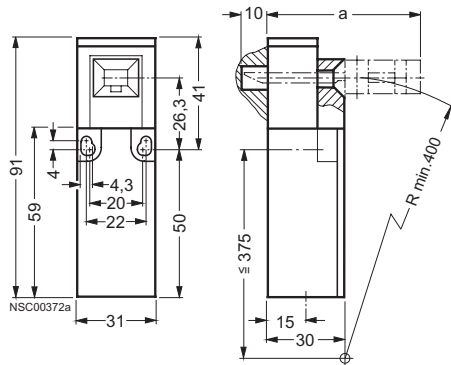

**3SE2 200-XX04, front-end actuation**

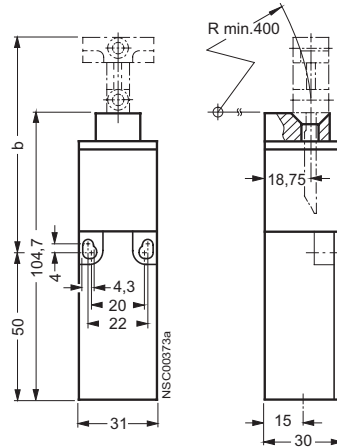

Permissible center offset  
of actuator to position switch:  
vertical and horizontal  $\pm 1$  mm

Actuator	A	B
Short	42 ... 45	66.5 ... 69
Long	62 ... 65	86.5 ... 89

Radius actuation:  
For all radii  $\geq 50$  mm,  
lateral and front-end actuation

**3SX3 196 short actuator**

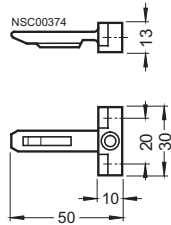

**3SX3 195 long actuator**

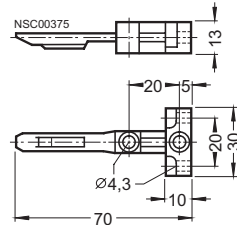

**3SE3 200-XX13, 5 directions of approach**

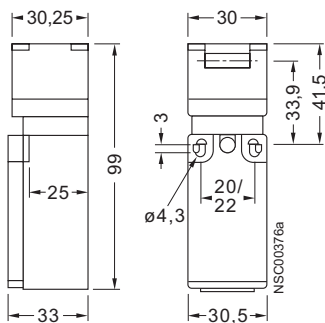

Radius actuation:  
For all radii  $\geq 50$  mm,  
lateral and front-end actuation

**3SX3 220 standard actuator**

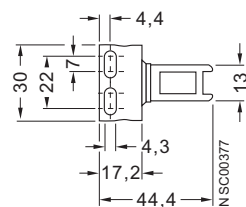

**3SX3 221 actuator for transverse fixing**

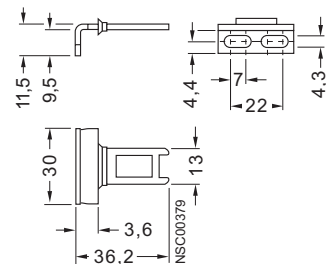

**3SX3 254 radius actuator**

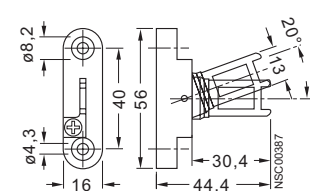

# SIGUARD Position Switches

## Position Switches with Separate Actuator

Molded-plastic enclosures, 31 mm wide

### Further information

#### Operation, operating speed and travel of actuators

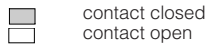
Actuator	Operation by a separate bar	Switch blocks	Nominal travel	Minimum force required in operating direction on retraction
	$v_{max}$ max. operating speed → direction of operation  Radius actuation: for all approach directions	Terminal designation acc. to EN 50013	 contact closed contact open  Actuator in actuator head; NC is closed	

#### Separate actuators

#### Slow-action contacts

**3SE2 200-XX03**      **3SE2 200-XX04**

Lateral actuation  
 $v_{max} = 1.5 \text{ m/s}$

Axial and front-end actuation  
 $v_{max} = 1 \text{ m/s}$

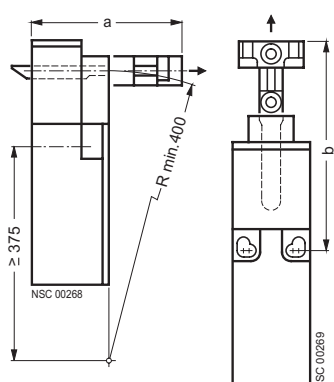

**1 NO + 1 NC**

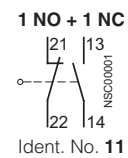

Ident. No. **11**

**2 NC**

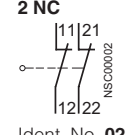

Ident. No. **02**

Actuator	a	b
Short	42 ... 45	66.5 ... 69
Long	62 ... 65	86.5 ... 89

lateral actuation      for front-end operation

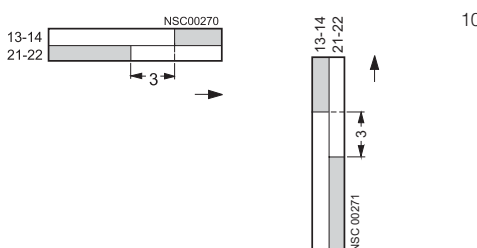

10 N

**3SE3 200-XX13**

Axial and lateral actuation (4 × 90°)

Vertical actuation

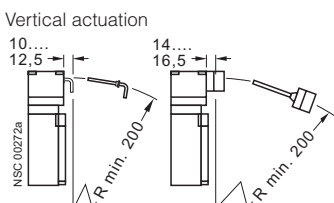

**1 NO + 1 NC**

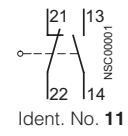

Ident. No. **11**

**2 NC**

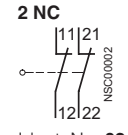

Ident. No. **02**

10 N

Horizontal actuation

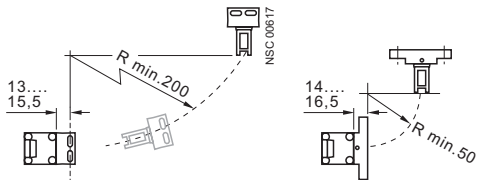

11

# SIGUARD Position Switches

## Position Switches with Separate Actuator

Molded-plastic enclosures, 52 mm wide

### Selection and ordering data

1 or 3 contacts · Moving double break contacts · IP67 degree of protection

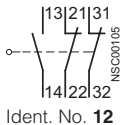
Actuation	Enclosure width/ actuator length mm	Slow-action contacts/ Ident. No. acc. to EN 50013	DT	Order No.	PS*	Weight per PU approx. kg	
<b>Molded-plastic enclosures in special widths</b>							
 <p><b>Lateral and front-end actuation <sup>1)</sup></b></p> <ul style="list-style-type: none"> <li>• Extraction force 5 N</li> <li>• Extraction force 30 N</li> <li>• With automatic ejection</li> </ul>	52	6 mm stroke <b>1 NO + 2 NC</b>  Ident. No. <b>12</b>		<ul style="list-style-type: none"> <li>→ <b>3SE2 243-0XX40</b></li> <li>→ <b>3SE2 243-0XX</b></li> <li>→ <b>3SE2 243-0XX30</b></li> </ul>	1 unit	0.139	
	52			<ul style="list-style-type: none"> <li>→ <b>3SE2 257-6XX40</b></li> <li>→ <b>3SE2 257-6XX</b></li> <li>→ <b>3SE2 257-6XX30</b></li> </ul>	1 unit	0.117	
	52			<ul style="list-style-type: none"> <li>→ <b>3SE2 257-6XX</b></li> <li>→ <b>3SE2 257-6XX30</b></li> </ul>	1 unit	0.118	
	52				1 unit	0.118	
	27			A	<b>3SX3 218</b>	1 unit	0.021
	33			A	<b>3SX3 228</b>	1 unit	0.023
			A	<b>3SX3 217</b>	1 unit	0.032	
			A	<b>3SX3 234</b>	1 unit	0.032	
<b>Actuators</b>							
			A	<b>3SX3 233</b>	3 units	0.003	
<b>Accessories</b>							
			A				

→ Positive opening according to IEC 60947-5-1, Appendix K.

1) Supplied without actuator.

# SIGUARD Position Switches

## Position Switches with Separate Actuator

Molded-plastic enclosures, 52 mm wide

### Dimension drawings

**3SE2 243, side and front-end actuation, with 3SX3 218 standard actuator**

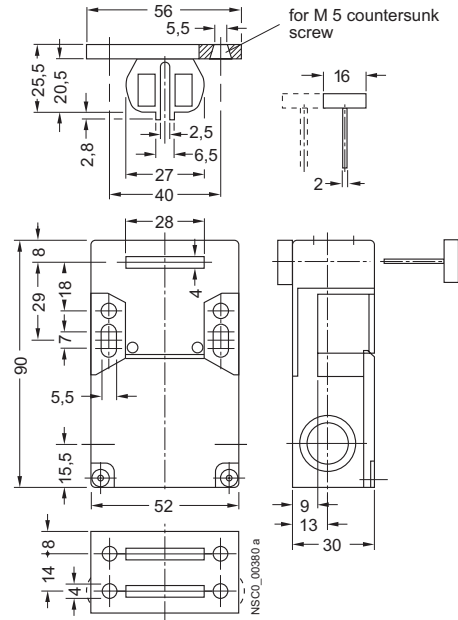

**3SE2 257, side and front-end actuation**

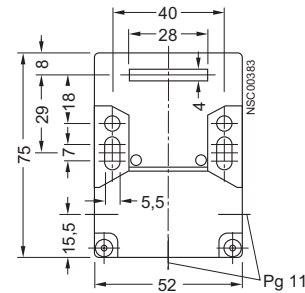

**3SX3 228 universal radius actuator**

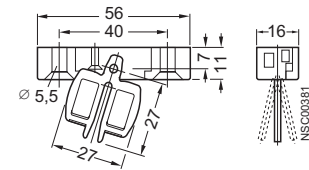

**3SX3 217 ball locating**

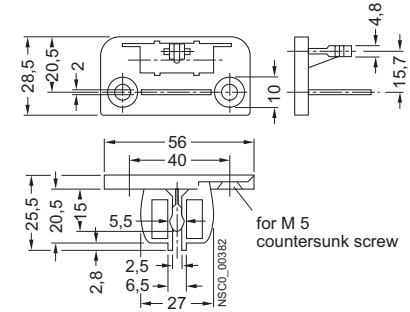

### Further information

#### Operation, operating speed and travel of actuators

Actuator	Operation by a separate bar	Switch blocks	Nominal travel	Minimum force required in operating direction on retraction
	$v_{max}$ max. operating speed → direction of operation  Radius actuation: for all approach directions	Terminal designation acc. to EN 50013	<div style="display: flex; align-items: center;"> <div style="width: 15px; height: 10px; background-color: #ccc; margin-right: 5px;"></div> contact closed  <div style="width: 15px; height: 10px; border: 1px solid #ccc; margin-right: 5px;"></div> contact open                       Actuator in actuator head; NC is closed                 </div>	

#### Separate actuator

Side and front-end actuation  
**3SE2 243--XX., 3SE2 257--XX.**

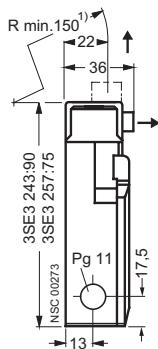

#### Slow-action contacts

**1 NO + 2 NC**

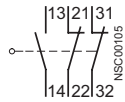

Ident. No. **12**

**1 NC**



Ident. No. **01**

#### lateral actuation

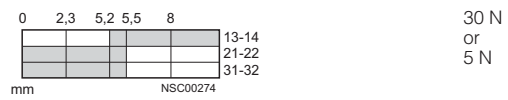

30 N  
or  
5 N

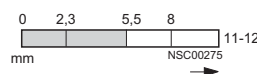

1) Radius actuator:  $R_{min} > 38$  mm.





# SIGUARD Position Switches

## Position Switches with Separate Actuator

Metal enclosures, 40 mm wide

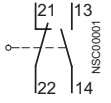
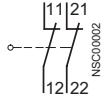
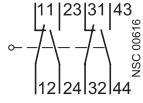
### Selection and ordering data

2 or 4 contacts · Moving double break contacts · IP67 degree of protection

Actuation/Fixing	Enclosure width/ actuator length mm	Slow-action contacts/ Ident. No. acc. to EN 50013	DT	Order No.	PS*	Weight per PU approx. kg
<b>Metal enclosures acc. to EN 50041</b>						
 <p><b>Lateral actuation</b> <sup>1)</sup></p> <ul style="list-style-type: none"> <li>with M 20 × 1,5 connecting thread</li> </ul>	40	6 mm stroke <b>1 NO + 1 NC</b>  Ident. No. <b>11</b>	B	→ <b>3SE2 120-0XX</b>	1 unit	0.350
	40	<b>2 NC</b>  Ident. No. <b>02</b>	B	→ <b>3SE2 120-6XX</b>	1 unit	0.350
	40	<b>2 NO + 2 NC</b>  Ident. No. <b>22</b>	B	→ <b>3SE2 120-4XX</b>	1 unit	0.354
<b>Actuator</b>						
 <ul style="list-style-type: none"> <li>Standard</li> </ul>	79		▶	<b>3SX3 197</b>	1 unit	0.027
 <ul style="list-style-type: none"> <li>With transverse fixing</li> </ul>	50		▶	<b>3SX3 206</b>	1 unit	0.024
 <ul style="list-style-type: none"> <li>Universal radius actuator</li> </ul>	80		A	<b>3SX3 203</b>	1 unit	0.113

→ Positive opening according to IEC 60947-5-1, Appendix K.

1) Supplied without actuator.

2) Radius actuator (universal):  $R_{\min} > 70$  mm.

# SIGUARD Position Switches

## Position Switches with Separate Actuator

Metal enclosures, 40 mm wide

### Dimension drawings

3SE2 120-XX, lateral actuation

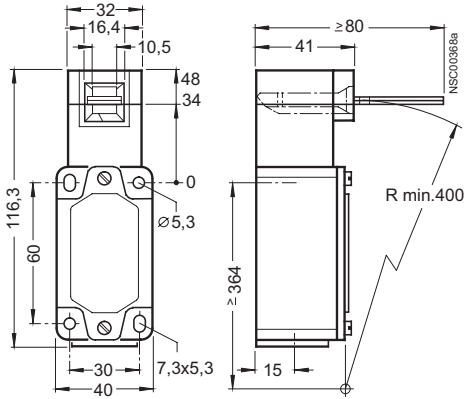

3SX3 206 actuator for transverse fixing

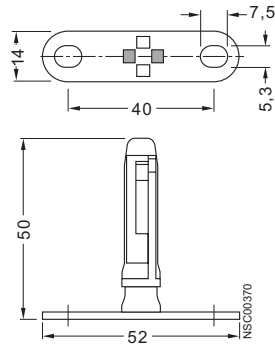

3SX3 203 universal radius actuator

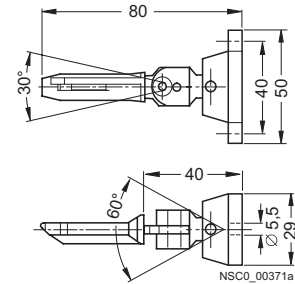

3SX3 197 actuator for lengthwise fixing

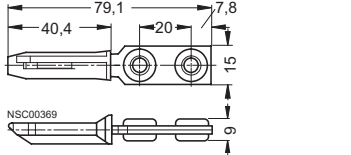

### Further information

#### Operation, operating speed and travel of actuators

Actuator	Operation by a separate bar	Switch blocks	Nominal travel	Minimum force required in operating direction on retraction
	$v_{max}$ max. operating speed $\rightarrow$ direction of operation  Radius actuation: for all approach directions	Terminal designation acc. to EN 50013	■ contact closed □ contact open  Actuator in actuator head; NC is closed	

#### Separate actuator

Lateral actuation  
 $v_{max} = 1 \text{ m/s}$

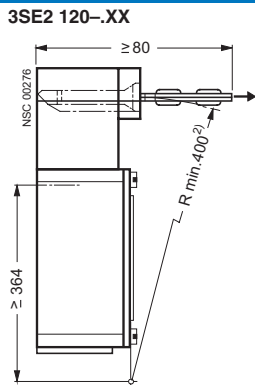

#### Slow-action contacts

1 NO + 1 NC

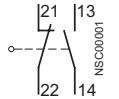

Ident. No. 11

2 NC

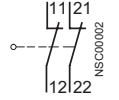

Ident. No. 02

2 NO + 2 NC

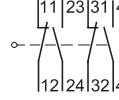

Ident. No. 22

lateral actuation

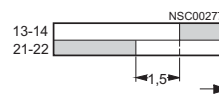

10 N

# SIGUARD Position Switches

## Position Switches with Separate Actuator and Tumbler

### General data

#### Overview

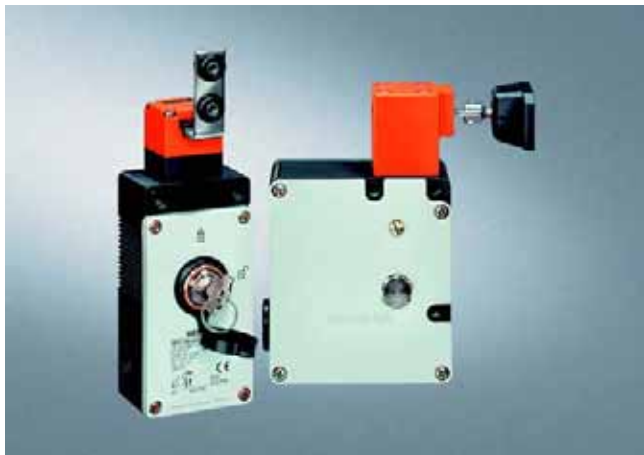

#### Area of application

The SIGUARD position switches with tumbler are exceptional, technically safe devices which restrict and prevent an unforeseen or intentional opening of protective doors, protective grilles or other covers as long as a dangerous situation is present (i.e. follow-on motion of the shutdown machine).

#### Approvals

3SE2 8 metal-enclosed position switches with tumbler have been awarded a test certificate from the BIA (Berufsgenossenschaftliches Institut für Arbeitssicherheit).

The switches are approved for use with locking devices to EN 1088 and EN 292, Parts 1 and 2.

#### Design

SIGUARD position switches with tumbler are offered in molded-plastic or metal enclosures.

#### Actuation

The actuators are not included in the scope of supply of the switch and must be ordered separately.

The actuator with lateral actuation can be adjusted through  $4 \times 90^\circ$ . The 3SE3 .5. and 3SE3 .6. switches can also be approached from above.

A universal radius actuator is available for small actuating radii; the actuator can be moved in all 4 directions.

#### Tumbler

The separate actuator operates in a similar way to the coding of a key and protects against manipulation. It transmits the locking force to the protection system and helps to monitor its position.

There are two types of locking:

- In the standard version, the position switch locks by means of spring force and releases by means of electromagnetic force (closed-circuit principle). In the case of voltage failure, it reliably prevents the protective device from opening when machine parts are still moving. For emergency situations or in setup mode, the switch is equipped with an auxiliary release which is secured against unauthorized use either with a seal or lock. This means that release is still possible for authorized personnel when a power failure has occurred.
- The second version offers locking by means of electromagnetic force and release by means of spring force (open-circuit principle). This version has an advantage when it is necessary to quickly access the machine after a power failure occurs, or in the case of very short after-running times.

#### Contacts

Switch with 4 contacts: monitoring the actuator or position of the protective door as well as monitoring the position of the magnet.

The mechanical design of the switch corresponds to the requirements of the failsafe principle to EN 1088.

#### Functions

##### Optical signaling device

The 3SE2 83 and 3SE2 84 position switches are also available with an optical signaling device.

The signaling device indicates the switching position of the lock and the protective device optically by means of 2 LEDs on the enclosure surface (only possible with contact arrangement of 1 NO/1 NC + 1 NO/1 NC).

Protective device	Tumbler	Indication	Meaning
Closed	Open	Yellow and green	Actuator free to be pulled
Closed	Closed	Green	Actuator locked
Open	Open	Yellow	Actuator pulled

# SIGUARD Position Switches

## Position Switches with Separate Actuator and Tumbler

### General data

#### Technical specifications

Type	3SE2 8, 3SE3 7, 3SE3 8		
<b>Standards</b>	IEC 60947-5-1, EN 60947-5-1		
<b>Rated insulation voltage <math>U_i</math></b>	V	250	
<b>Pollution degree</b> acc. to EN 60664		Class 3	
<b>Rated operating voltage <math>U_e</math></b>			
• DC	V	24	
• AC 50 ... 60 Hz	V	110 ... 130	230
<b>Continuous thermal current <math>I_{th}</math></b>	A	10	
<b>Rated operating current <math>I_e</math></b>			
• For alternating current 40 ... 60 Hz		$I_e$ / AC-12	$I_e$ / AC-15
- at 24 V	A	10	4
- at 60 V	A	10	4
- at 110 V	A	10	4
- at 230 V	A	10	4
• For direct current		$I_e$ / DC-12	$I_e$ / DC-13
- at 24 V	A	10	3
- at 60 V	A	5	1.5
- at 110 V	A	2.5	0.7
- at 220 V	A	1	0.3
<b>Short circuit protection<sup>1)</sup></b> , DIAZED fuse links			
• Operational class gL/gG	A	6	
• Quick response characteristic	A	10	
<b>Mechanical endurance</b>		1 × 10 <sup>6</sup> operating cycles	
<b>Electrical endurance</b>			
• With 3RH11, 3RT10 16 to 3RT10 26 contactors		1 × 10 <sup>6</sup> operating cycles	
• For AC-15 duty		0.5 × 10 <sup>6</sup> operating cycles when interrupting $I_e$ / AC-15 at 230 V	
• For DC-13 duty		With DC the contact endurance depends not only on the breaking current but also on the voltage, the circuit inductance and the speed of switching. No generally valid information can be given.	
<b>Operating frequency</b> with 3RH11, 3RT10 16 to 3RT10 26 contactors		6 × 10 <sup>3</sup> operating cycles/h	

Type	3SE3 75, 3SE3 76	3SE3 85, 3SE3 86	3SE2 83, 3SE3 84
<b>Enclosure</b>	Fiber-glass strengthened thermo-plastic	Aluminum (GD - AISi 12)	Aluminum (GD - AISi 12)
<b>Degree of protection</b> acc. to IEC 60529	IP66		IP67
<b>Ambient temperature</b>			
• in operation	-30 ... +70 °C		
• for storage, transport			
<b>Mounting position</b>	Any		
<b>Cable entry</b>	Pg 13.5		M 20 × 1.5
<b>Conductor cross-sections</b>			
• Solid	2 × 1.5 mm <sup>2</sup>		2 × 2.5 mm <sup>2</sup>
• Finely stranded with end sleeve	2 × 1.0 mm <sup>2</sup>		2 × 1.5 mm <sup>2</sup>
<b>Protective conductor terminal</b> inside enclosure	-	M 3.5	M 3.5

1) Without any welds according to IEC 60947-5-1.









# SIGUARD Position Switches

## Position Switches with Separate Actuator and Tumbler

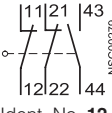
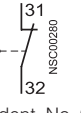
Molded-plastic enclosures, locking force 1200 N

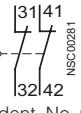
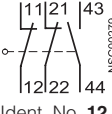
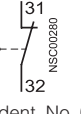
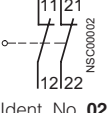
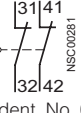
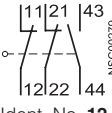
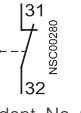
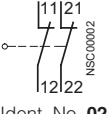
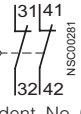
### Selection and ordering data

4 contacts · Moving double-break contacts · 5 directions of approach · Locking force 1200 N · IP67 degree of protection

Tumbler	Magnet, rated operating voltage	Slow-action contacts/ Ident. No. acc. to EN 50013	DT	Order No.	PS*	Weight per PU approx.	
	V	Position monitoring of magnet Position monitoring of actuator				kg	
<b>Molded-plastic enclosures in special widths</b>							
	<b>Spring actuated lock</b> <sup>1) 2)</sup>		6 mm stroke				
	• Standard, with auxiliary release, sealable	DC 24	<b>1 NO + 2 NC</b>	<b>1 NC</b>	B	→ <b>3SE3 760-3XX00</b>	1 unit 0.358
		AC 110			B	→ <b>3SE3 762-3XX00</b>	1 unit 0.353
		AC 230			B	→ <b>3SE3 761-3XX00</b>	1 unit 0.348
			Ident. No. <b>12</b>	Ident. No. <b>01</b>			
		DC 24	<b>2 NC</b>	<b>2 NC</b>	B	→ <b>3SE3 760-6XX00</b>	1 unit 0.357
		AC 110			B	→ <b>3SE3 762-6XX00</b>	1 unit 0.350
		AC 230			B	→ <b>3SE3 761-6XX00</b>	1 unit 0.350
			Ident. No. <b>02</b>	Ident. No. <b>02</b>			
	• Aux. release with lock	DC 24 AC 110 AC 230	<b>1 NO + 2 NC</b>	<b>1 NC</b>	B	→ <b>3SE3 760-3XX01</b>	1 unit 0.001
					B	→ <b>3SE3 762-3XX01</b>	1 unit 0.380
					B	→ <b>3SE3 761-3XX01</b>	1 unit 0.382
			Ident. No. <b>12</b>	Ident. No. <b>01</b>			
DC 24 AC 110 AC 230		<b>2 NC</b>	<b>2 NC</b>	B	→ <b>3SE3 760-6XX01</b>	1 unit 0.390	
				B	→ <b>3SE3 762-6XX01</b>	1 unit 0.391	
			B	→ <b>3SE3 761-6XX01</b>	1 unit 0.377		
		Ident. No. <b>02</b>	Ident. No. <b>02</b>				
<b>Magnetic field lock</b> <sup>1) 2)</sup>		6 mm stroke					
	DC 24 AC 110 AC 230	<b>1 NO + 2 NC</b>	<b>1 NC</b>	B	→ <b>3SE3 750-3XX00</b>	1 unit 0.361	
				B	→ <b>3SE3 752-3XX00</b>	1 unit 0.354	
				B	→ <b>3SE3 751-3XX00</b>	1 unit 0.350	
		Ident. No. <b>12</b>	Ident. No. <b>01</b>				
	DC 24 AC 110 AC 230	<b>2 NC</b>	<b>2 NC</b>	B	→ <b>3SE3 750-6XX00</b>	1 unit 0.362	
				B	→ <b>3SE3 752-6XX00</b>	1 unit 0.354	
				B	→ <b>3SE3 751-6XX00</b>	1 unit 0.354	
		Ident. No. <b>02</b>	Ident. No. <b>02</b>				
<b>Actuator</b>							
	• Standard actuator			B	<b>3SX3 252</b>	1 unit 0.032	
		• With transverse fixing		B	<b>3SX3 253</b>	1 unit 0.032	
			• Radius actuator		B	<b>3SX3 254</b>	1 unit 0.017

→ Positive opening according to IEC 60947-5-1, Appendix K.

1) Supplied without actuator.

2) For metric connection, the Pg 13.5 to M 20 × 1.5 adapter must be ordered separately.

\* This quantity or a multiple thereof can be ordered

Siemens LV 10 · 2004

11/59

# SIGUARD Position Switches

## Position Switches with Separate Actuator and Tumbler

Molded-plastic enclosures, locking force 1200 N

### Dimension drawings

3SE3 75.-XX, 3SE3 76.-XX

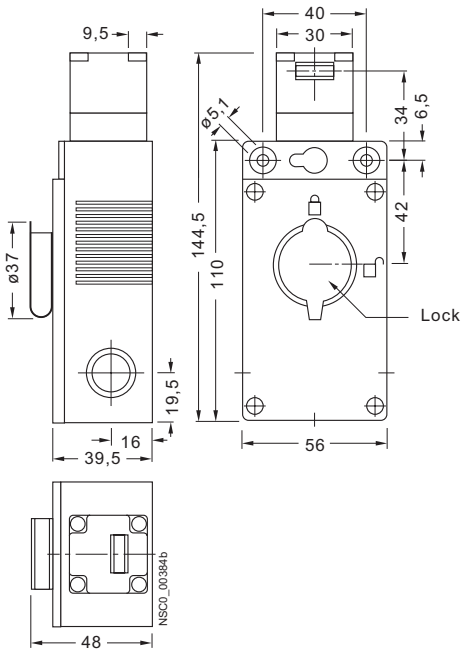

3SX3 252 standard actuator

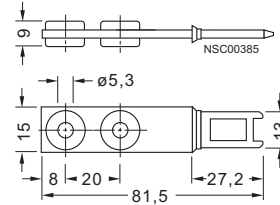

3SX3 253 actuator for transverse fixing

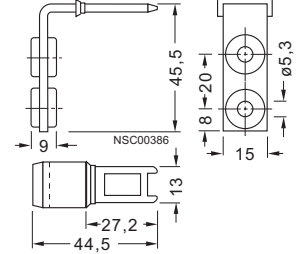

3SX3 254 radius actuator

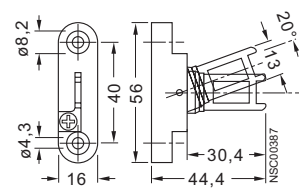

### Further information

#### Operation, operating speed and travel of actuators

Actuator	Operation by a separate bar	Switch blocks	Nominal travel	Minimum force required in operating direction on retraction
	$v_{max}$ max. operating speed $\rightarrow$ direction of operation  Radius actuation: for all approach directions	Terminal designation acc. to EN 50013	■ contact closed □ contact open  Actuator in actuator head; NC is closed	
			lateral actuation	

#### Separate actuator, with tumbler

Axial and lateral actuation (4 × 90°)

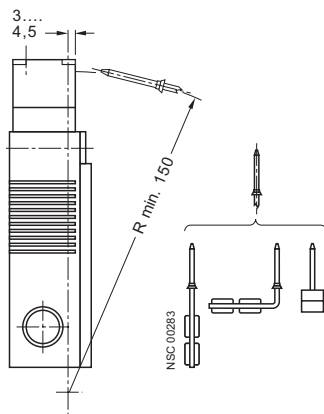

#### Slow-action contacts

20 N





# SIGUARD Position Switches

## Position Switches with Separate Actuator and Tumbler

Metal enclosures, locking force 1200 N

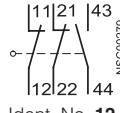
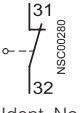
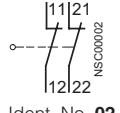
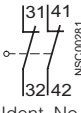
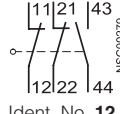
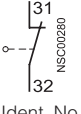
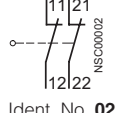
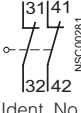
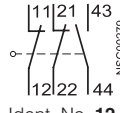
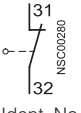
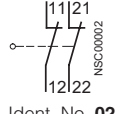
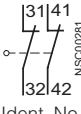
### Selection and ordering data

4 contacts · Moving double-break contacts · 5 directions of approach · Locking force 1200 N · IP67 degree of protection

Tumbler	Magnet, rated operating voltage	Slow-action contacts/ Ident. No. acc. to EN 50013	DT	Order No.	PS*	Weight per PU approx.	
	V	Position monitoring of magnet Position monitoring of actuator				kg	
<b>Metal enclosures in special widths</b>							
	<b>Spring actuated lock</b> <sup>1) 2)</sup>		6 mm stroke				
	• Standard, with auxiliary release, sealable	DC 24	<b>1 NO + 2 NC</b>	<b>1 NC</b>	B	→ <b>3SE3 860-3XX00</b>	1 unit 0.001
		AC 110			B	→ <b>3SE3 862-3XX00</b>	1 unit 0.722
		AC 230			B	→ <b>3SE3 861-3XX00</b>	1 unit 0.717
			Ident. No. <b>12</b>	Ident. No. <b>01</b>			
		DC 24	<b>2 NC</b>	<b>2 NC</b>	B	→ <b>3SE3 860-6XX00</b>	1 unit 0.725
		AC 110			B	→ <b>3SE3 862-6XX00</b>	1 unit 0.715
		AC 230			B	→ <b>3SE3 861-6XX00</b>	1 unit 0.712
			Ident. No. <b>02</b>	Ident. No. <b>02</b>			
	• Aux. release with lock	DC 24 AC 110 AC 230	<b>1 NO + 2 NC</b>	<b>1 NC</b>	B	→ <b>3SE3 860-3XX01</b>	1 unit 0.756
					B	→ <b>3SE3 862-3XX01</b>	1 unit 0.755
					B	→ <b>3SE3 861-3XX01</b>	1 unit 0.750
			Ident. No. <b>12</b>	Ident. No. <b>01</b>			
DC 24 AC 110 AC 230		<b>2 NC</b>	<b>2 NC</b>	B	→ <b>3SE3 860-6XX01</b>	1 unit 0.757	
				B	→ <b>3SE3 862-6XX01</b>	1 unit 0.766	
			B	→ <b>3SE3 861-6XX01</b>	1 unit 0.747		
		Ident. No. <b>02</b>	Ident. No. <b>02</b>				
<b>Magnetic field lock</b> <sup>1) 2)</sup>		6 mm stroke					
	DC 24 AC 110 AC 230	<b>1 NO + 2 NC</b>	<b>1 NC</b>	B	→ <b>3SE3 850-3XX00</b>	1 unit 0.727	
				B	→ <b>3SE3 852-3XX00</b>	1 unit 0.726	
				B	→ <b>3SE3 851-3XX00</b>	1 unit 0.720	
		Ident. No. <b>12</b>	Ident. No. <b>01</b>				
	DC 24 AC 110 AC 230	<b>2 NC</b>	<b>2 NC</b>	B	→ <b>3SE3 850-6XX00</b>	1 unit 0.728	
				B	→ <b>3SE3 852-6XX00</b>	1 unit 0.721	
				B	→ <b>3SE3 851-6XX00</b>	1 unit 0.720	
		Ident. No. <b>02</b>	Ident. No. <b>02</b>				
<b>Actuator</b>							
	• Standard actuator			B	<b>3SX3 252</b>	1 unit 0.032	
		• With transverse fixing		B	<b>3SX3 253</b>	1 unit 0.032	
			• Radius actuator		B	<b>3SX3 254</b>	1 unit 0.017

→ Positive opening according to IEC 60947-5-1, Appendix K.

1) Supplied without actuator.

2) For metric connection, the Pg 13.5 to M 20 × 1.5 adapter must be ordered separately.

\* This quantity or a multiple thereof can be ordered

Siemens LV 10 · 2004

11/61

# SIGUARD Position Switches

## Position Switches with Separate Actuator and Tumbler

Metal enclosures, locking force 1200 N

### Dimension drawings

3SE3 85.-XX, 3SE3 86.-XX

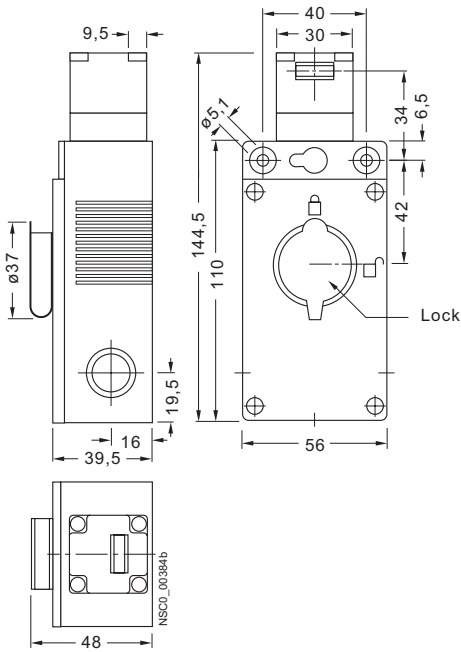

3SX3 252 standard actuator

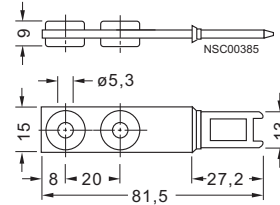

3SX3 253 actuator for transverse fixing

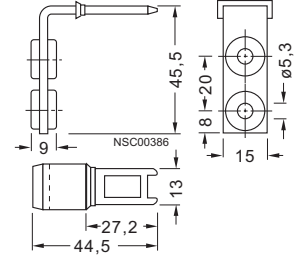

3SX3 254 radius actuator

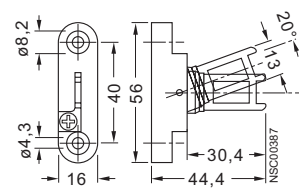

### Further information

#### Operation, operating speed and travel of actuators

Actuator	Operation by a separate bar	Switch blocks	Nominal travel	Minimum force required in operating direction on retraction
$v_{max}$ →	max. operating speed direction of operation	Terminal designation acc. to EN 50013	<div style="display: flex; align-items: center;"> <div style="width: 10px; height: 10px; background-color: gray; margin-right: 5px;"></div> contact closed  <div style="width: 10px; height: 10px; border: 1px solid black; margin-right: 5px;"></div> contact open                 </div>	Actuator in actuator head; NC is closed
	Radius actuation: for all approach directions		Actuator in actuator head; NC is closed	
			lateral actuation	

#### Separate actuator, with tumbler

Axial and lateral actuation (4 × 90°)

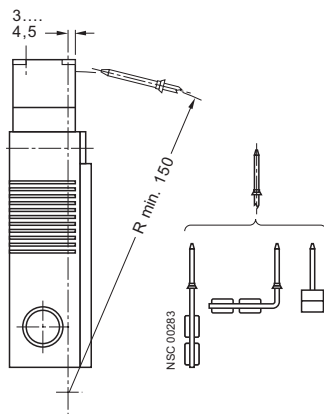

#### Slow-action contacts

20 N







# SIGUARD Position Switches

## Position Switches with Separate Actuator and Tumbler

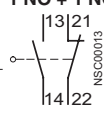
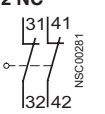
Metal enclosures, locking force 2000 N

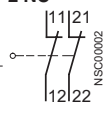
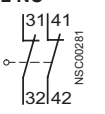
### Selection and ordering data

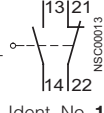
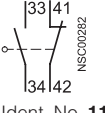
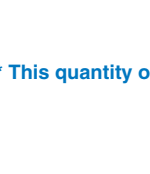
4 contacts · Moving double-break contacts · Locking force 2000 N · IP67 degree of protection

Tumbler/ Signaling equipment	Magnet, rated operating voltage	Slow-action contacts/ Ident. No. acc. to EN 50013	DT	Order No.	PS*	Weight per PU approx.	
		Position monitor- ing of actuator	Position monitor- ing of magnet			kg	
	<b>Spring actuated lock <sup>1)</sup></b>		6 mm stroke				
	• Standard, with auxiliary release, sealable	DC 24	<b>1 NO + 1 NC</b> 	<b>2 NC</b> 	D	→ <b>3SE2 840-0XX00</b>	1 unit 0.885
		AC 110			D	→ <b>3SE2 842-0XX00</b>	1 unit 0.887
	AC 230			D	→ <b>3SE2 841-0XX00</b>	1 unit 0.875	
	• Aux. release with lock	DC 24	Ident. No. <b>11</b>	Ident. No. <b>02</b>	A	→ <b>3SE2 840-0XX01</b>	1 unit 0.935
		AC 110			D	→ <b>3SE2 842-0XX01</b>	1 unit 0.925
AC 230		D			→ <b>3SE2 841-0XX01</b>	1 unit 0.916	
	<b>Magnetic field lock <sup>1)</sup></b>						
	• Standard	DC 24			D	→ <b>3SE2 830-0XX00</b>	1 unit 0.865
		AC 110			D	→ <b>3SE2 832-0XX00</b>	1 unit 0.855
		AC 230			D	→ <b>3SE2 831-0XX00</b>	1 unit 0.855
	<b>Spring actuated lock <sup>1)</sup></b>		6 mm stroke				
	• Standard, with auxiliary release, sealable	DC 24	<b>2 NC</b> 	<b>2 NC</b> 	D	→ <b>3SE2 840-6XX00</b>	1 unit 0.885
		AC 110			D	→ <b>3SE2 842-6XX00</b>	1 unit 0.880
		AC 230			D	→ <b>3SE2 841-6XX00</b>	1 unit 0.877
	• Aux. release with lock	DC 24	Ident. No. <b>02</b>	Ident. No. <b>02</b>	D	→ <b>3SE2 840-6XX01</b>	1 unit 0.931
		AC 110			D	→ <b>3SE2 842-6XX01</b>	1 unit 0.920
AC 230		D			→ <b>3SE2 841-6XX01</b>	1 unit 0.925	
	<b>Magnetic field lock <sup>1)</sup></b>						
	• Standard	DC 24			D	→ <b>3SE2 830-6XX00</b>	1 unit 0.858
		AC 110			D	→ <b>3SE2 832-6XX00</b>	1 unit 0.848
		AC 230			D	→ <b>3SE2 831-6XX00</b>	1 unit 0.849
	<b>Spring actuated lock, with optical signaling equipment <sup>1)</sup></b>		6 mm stroke				
	• Standard, with auxiliary release, sealable	DC 24	<b>1 NO + 1 NC</b> 	<b>1 NO + 1 NC</b> 	A	→ <b>3SE2 840-1XX20</b>	1 unit 0.883
		AC 110			D	→ <b>3SE2 842-1XX20</b>	1 unit 0.885
		AC 230			D	→ <b>3SE2 841-1XX20</b>	1 unit 0.880
	• Aux. release with lock	DC 24	Ident. No. <b>11</b>	Ident. No. <b>11</b>	D	→ <b>3SE2 840-1XX32</b>	1 unit 0.945
		AC 110			D	→ <b>3SE2 842-1XX32</b>	1 unit 0.922
AC 230		D			→ <b>3SE2 841-1XX32</b>	1 unit 0.930	
	<b>Magnetic field lock <sup>1)</sup></b>						
	• Standard	DC 24			D	→ <b>3SE2 830-1XX00</b>	1 unit 0.868
		AC 110			D	→ <b>3SE2 832-1XX00</b>	1 unit 0.845
		AC 230			D	→ <b>3SE2 831-1XX00</b>	1 unit 0.854
• With optical signaling equipment	DC 24			D	→ <b>3SE2 830-1XX20</b>	1 unit 0.881	
	AC 110			D	→ <b>3SE2 832-1XX20</b>	1 unit 0.860	
	AC 230			D	→ <b>3SE2 831-1XX20</b>	1 unit 0.875	
	<b>Actuator</b>		Length:				
	• Standard actuator		79 mm	▶	<b>3SX3 197</b>	1 unit 0.027	
		- For approach from the left		132 mm	B	<b>3SX3 207</b>	1 unit 0.045
		- With transverse fixing		50 mm	▶	<b>3SX3 206</b>	1 unit 0.024
• Universal radius actuator		80 mm	A	<b>3SX3 203</b>	1 unit 0.113		

→ Positive opening according to IEC 60947-5-1, Appendix K.

1) Supplied without actuator.

# SIGUARD Position Switches

## Position Switches with Separate Actuator and Tumbler

Metal enclosures, locking force 2000 N

### Dimension drawings

3SE2 83.-XX, 3SE2 84.-XX, lateral actuation

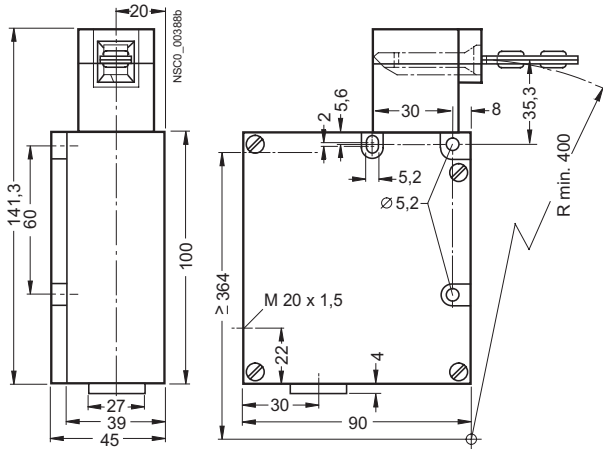

3SX3 197 actuator for lengthwise fixing

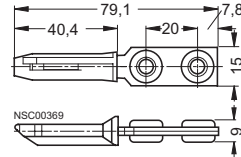

3SX3 206 actuator for transverse fixing

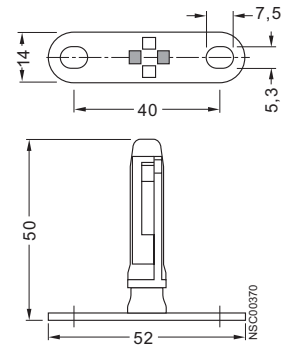

3SX3 207 actuator for approach direction from the left side

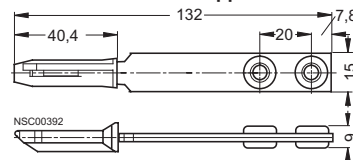

3SX3 203 universal radius actuator

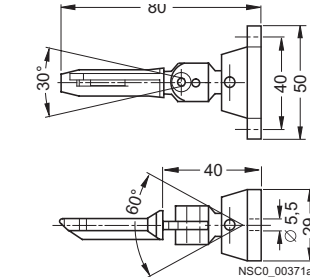

### Further information

#### Operation, operating speed and travel of actuators

Actuator	Operation by a separate bar	Switch blocks	Nominal travel	Minimum force required in operating direction on retraction
	$v_{max}$ max. operating speed → direction of operation Radius actuation: for all approach directions	Terminal designations acc. to EN 50013	<input checked="" type="checkbox"/> contact closed <input type="checkbox"/> contact open Actuator in actuator head; NC is closed	

#### Separate actuator, with tumbler

Lateral actuation (4 × 90°)

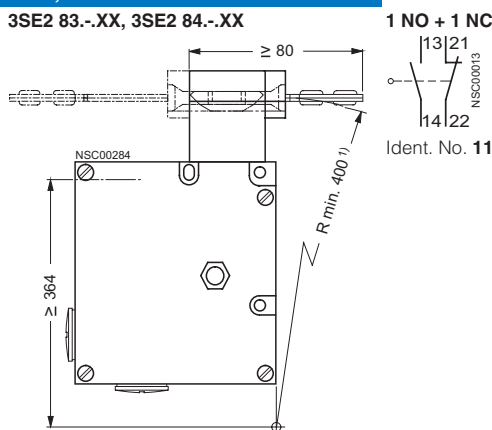

#### Slow-action contacts

1 NO + 1 NC

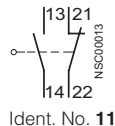

lateral actuation

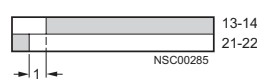

10 N  
Locking force:  
max. 2000 N<sub>2</sub>  
duration 5 s<sup>2</sup>)

$v_{max} = 1.5 \text{ m/s}$

- 1) Universal radius actuator:  $R_{min} > 70 \text{ mm}$ .
- 2) Destruction of internal parts will result if this value is exceeded.

## Molded-plastic enclosures

### Area of application

The hinge switches are used for monitoring and protecting hinged protection equipment such as doors and flaps. They fulfill the function of providing protection against personal injury. The NC contacts are positively opened in accordance with IEC 60947-5-1.

The 3SE2 200 hinge switches with snap-action contacts 1 NO + 1 NC with an angle of operation of 5° or 15° make "Switch-off" and "Signaling" possible for the first time without a time delay and with a small opening angle.

The 3SE2 283 hinge switches are particularly suitable for use in doors and flaps of machines that must be closed to ensure the safety of operating personnel. Its thin profile and compact design allow it to be directly mounted on a hinged protective cover and the stable frame.

### Design

#### 3SE2 200

The hinge switches are offered in a molded-plastic enclosure according to EN 50047. The enclosures correspond to the enclosures of the standard position switches. The switches are fitted with 1 NO + 1 NC contacts.

The switches designed for mounting on hinges must be attached directly to the hinge and guarantee ensured cut-off, with a high level of security against manipulation, even with very small opening angles. The switch button can be rotated through 4 x 90° after the four screws are unscrewed.

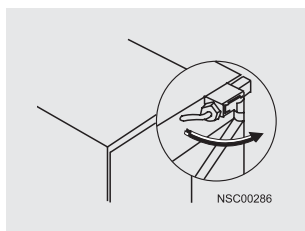

Mounting on hinges

#### 3SE2 283

The 3SE2 283 hinge switch has an integrated electromechanical switch block that is actuated when the hinged protective cover is opened. If the cover is only opened by 4°, the normally closed contact is positively opened by a direct (not spring-action) mechanism. These positively driven contacts guarantee inter-

ruption of the electric circuit and stopping of the machine. The normally open contact is closed when the cover is moved by 13.5°.

### Technical specifications

Type	3SE2 200
Rated insulation voltage $U_i$	500 V
Pollution degree	Class 3
Continuous thermal current $I_{th}$	10 A
Mechanical endurance	1 × 10 <sup>6</sup> operating cycles
Operating frequency	30 operating cycles/hour
Actuating force	<ul style="list-style-type: none"> <li>Mounting on hinges: 15 Ncm</li> <li>Mounting on hinged flaps: 7.5 Ncm</li> </ul>
Actuating speed	minimum of 0.5 m/s
Enclosure material	molded plastic
Degree of protection	IP66
Ambient temperature	-25 ... +85 °C
Cable entry	M 20 × 1.5
Conductor cross-sections	<ul style="list-style-type: none"> <li>Solid: 2 × 2.5 mm<sup>2</sup></li> <li>Finely stranded with end sleeve: 2 × 1.5 mm<sup>2</sup></li> </ul>

For further technical specifications, see Standard position switches.

Type	3SE2 283
Rated insulation voltage $U_i$	250 V
Continuous thermal current $I_{th}$	2.5 A
Rated operational current $I_e$	<ul style="list-style-type: none"> <li>at AC-15, 250 V: 2 A</li> <li>at DC-13, 24 V: 1 A</li> </ul>
Min. make-break capacity	> 5 V/1 mA
Short-circuit protection	2 A (operational class gG)
Mechanical endurance	> 1 × 10 <sup>6</sup> operating cycles
Operating frequency	1200 operating cycles/hour
Positive opening	2 mm after opening point
Enclosure material	molded plastic
Degree of protection	IP65
Ambient temperature	-25 ... +65 °C
Shock resistance	30 g/18 ms
Vibration strength	20 g/10 ... 200 Hz
Cable entry	M 20 × 1.5
Screw terminals	0.5 ... 1.5 mm <sup>2</sup> / AWG 15

### Further information

#### Actuator travels

##### 3SE2 200

##### 1 NO + 1 NC

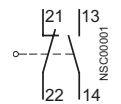

Ident. No. 11

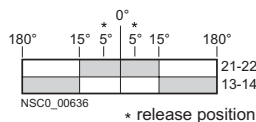

##### 3SE2 283

##### 1 NO + 2 NC

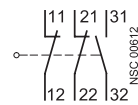

Ident. No. 12

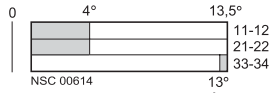

##### 3 NC

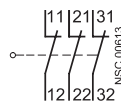

Ident. No. 03

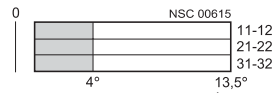



# SIGUARD Hinge Switches

## Molded-plastic enclosures

### Selection and ordering data

2 contacts · IP66 degree of protection (3SE2 283: IP65)

Version	Switch block	DT	Molded-plastic enclosure	PS*	Weight per PU approx.
			Order No.		kg
 <p><b>Mounting on hinges</b></p> <ul style="list-style-type: none"> <li>Solid shaft, d = 10 mm, 15° operating angle</li> <li>Hollow shaft, d<sub>i</sub> = 8 mm, 15° operating angle</li> <li>Solid shaft, d = 10 mm, 5° operating angle</li> <li>Hollow shaft, d<sub>i</sub> = 8 mm, 5° operating angle</li> </ul>	Snap-action contacts				
	1 NO + 1 NC	B	→ 3SE2 200-1GA11	1 unit	0.111
	1 NO + 1 NC	B	→ 3SE2 200-1GA10	1 unit	0.093
	1 NO + 1 NC	X	→ 3SE2 200-1GA31	1 unit	0.111
	1 NO + 1 NC	X	→ 3SE2 200-1GA30	1 unit	0.093
 <p><b>Hinge switch</b></p>	Slow-action contacts				
	1 NO + 2 NC	A	→ 3SE2 283-0GA43	1 unit	0.421
	3 NC	A	→ 3SE2 283-6GA43	1 unit	0.421
 <p><b>Additional hinge</b></p>		A	3SX3 225	1 unit	0.157

→ Positive opening according to IEC 60947-5-1, Appendix K.

### Dimension drawings

Hinge switches for mounting on hinges, molded-plastic enclosure, 3SE2 200-1GA..

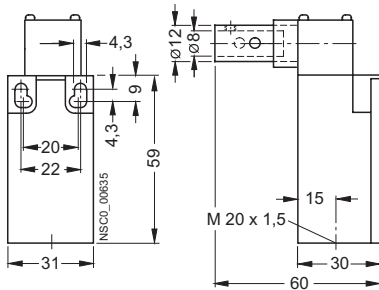

3SE2 283-.GA43 hinge switches

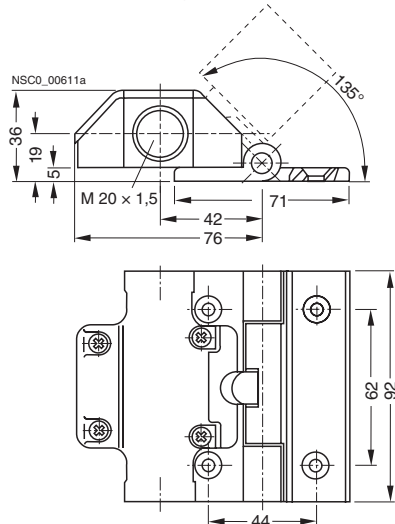

3SX3 225 additional hinge

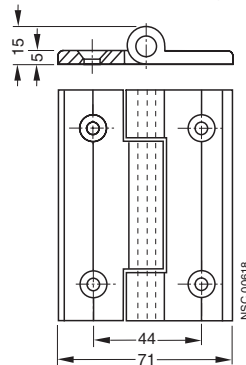



# SIGUARD Magnetically Operated Switches

## Magnetic monitoring system

### Area of application

SIGUARD 3SE6 magnetic monitoring systems are designed for mounting on movable protective guards (covers, flaps, doors, etc.).

The magnetically operated safety switches stand out due to their enclosed design with degree of protection IP67. They are particularly suitable for areas in which cleaning, disinfecting or contamination play an important role.

The individual systems offer a high level of security against manipulation and are approved as a unit for safety categories up to Category 4 in accordance with EN 954-1 by an employer's liability insurance association.

### Design

A complete system comprises a coded magnet, a magnetically operated switch (sensor unit) and a monitoring unit, e.g. the solid-state safety combination 3TK28 or AS-Interface Safety at Work.

The switch block and switching magnet must not be installed on ferromagnetic materials because the switching response will be influenced. Spacers can be used to prevent this.

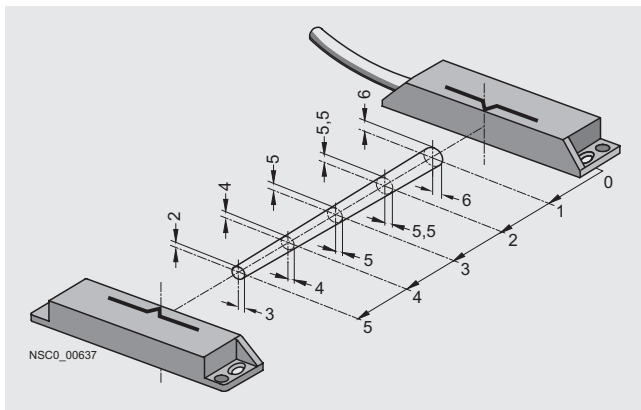

Enable range

### Technical specifications

#### Sensors (switch blocks)

<b>Type</b>	<b>3SE6 604-2BA</b>
<b>Standards</b>	DIN VDE 0660-209; EN 1088 (in combination with 3TK28 monitoring unit or AS-Interface)
<b>Operation</b>	Magnetic
<b>Operating voltage</b>	AC/DC 100 V
<b>Operating current</b>	400 mA
<b>Performance</b>	10 VA/W
<b>Max. switching frequency</b>	5 Hz
<b>Enclosure</b>	
<b>Degree of protection acc. to IEC 60529</b>	IP67
<b>Ambient temperature</b>	
• in operation	-25 °C ... +70 °C
• for storage, transport	-25 °C ... +70 °C
<b>Shock resistance</b>	10 g/11 ms
<b>Vibration resistance</b>	10 ... 55 Hz, amplitude 1 mm
<b>Conductor</b>	Cable LiYY 4 × 0.25 mm <sup>2</sup> ; length 3 m

### Selection and ordering data

	Version	Size	S <sub>an</sub> ... S <sub>ab</sub>	Contacts	DT	Order No.	PS*	Weight per PU approx.
		mm	mm					kg
<b>Rectangular sensor unit</b>								
	<b>Switching magnet (coded)</b>	25 × 88			A	<b>3SE6 704-2BA</b>	1 unit	0.028
	<b>Switch block</b>	25 × 88	5 ... 15	2 NC	A	<b>3SE6 604-2BA</b>	1 unit	0.157
<b>Accessories</b>								
	<b>Spacer</b>	25 × 88			A	<b>3SX3 260</b>	1 unit	0.018

\* This quantity or a multiple thereof can be ordered

# SIGUARD Magnetically Operated Switches

## Magnetic monitoring system

### Dimension drawings

3SE6 605-2BA switch block,  
3SE6 704-2BA coded switching magnet

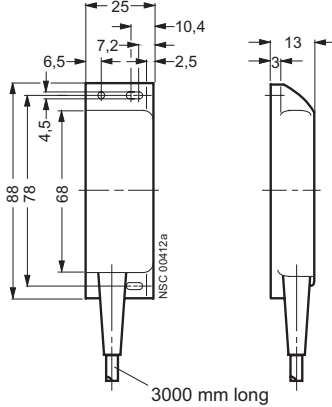

3SX3 260 spacer

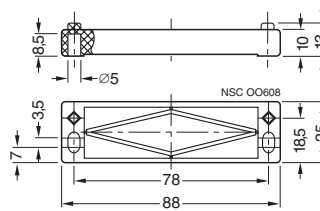

### Circuit diagrams

#### Connection examples

3SE6 604-2BA magnetically operated switch with 3TK28 safety combination, Category 4 acc. to EN 954-1

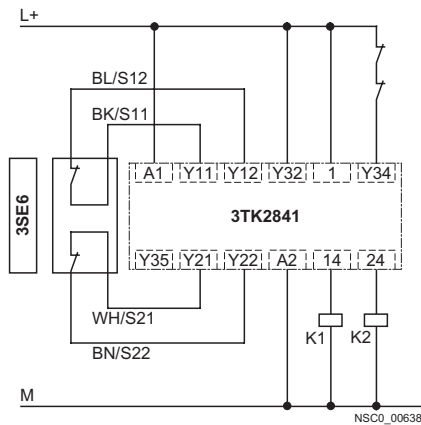

#### Switch block connection



NSC0\_00640

The specified switching position refers to the basic position when the cover, flap etc. is closed.

3SE6 604-2BA magnetically operated switch on AS-Interface Safety at Work, safe K45F or K60F compact module, Category 4 according to EN 954-1

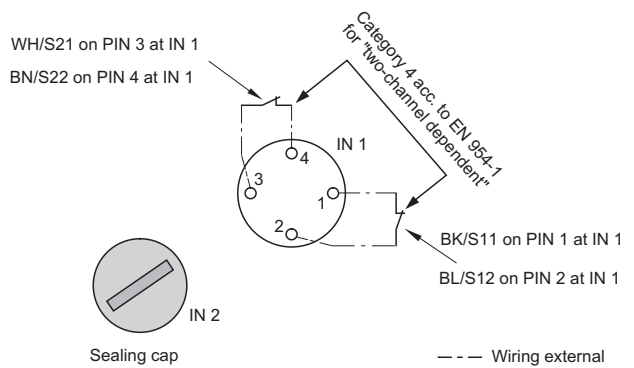

Abbreviations for color designation of the connecting leads acc. to IEC 60757:

- BK = black
- BL = blue
- BN = brown
- WH = white

# SIGUARD Cable-Operated Switches

## Metal enclosures

### Area of application

SIGUARD cable-operated switches are used for monitoring or for EMERGENCY-STOP facilities on particularly endangered system sections.

As the effective range of a cable-operated switch is only limited by the length of the pull-wire, large systems can also be protected.

Cable-operated switches (requiring pulling at both ends) and conveyor belt unbalance trackers are used primarily for monitoring very long belt systems.

#### Standards

Switches with positive latching for implementation in EMERGENCY-STOP equipment correspond to the EN 418 standard.

### Functions

The NC contacts of the cable-operated switch and the conveyor belt unbalance tracker are positive opening.

Cable-operated switches with one-side operation are held in free position by the pre-tension on the turnbuckle.

In the 3SE7 140 and 3SE7 150 cable-operated switches, both switching contacts are available for cable-break/cable-pull signaling. The NO contact can be used, for example, for signaling purposes.

On switches with interlocking, with a pretensioned cable, the locking must be deactivated beforehand in order to return the cable operated switch to its original position.

### Design

The switches for cable lengths up to 50 m are available with 1 NO + 1 NC or 2 NC contacts. The switches for cable lengths of 2 × 50 m and the conveyor belt unbalance trackers are supplied with 2 NO + 2 NC contacts.

The cable operated switch and the conveyor belt unbalance tracker can also be supplied with a factory-fitted LED (red, DC 24 V). This light in innovative on-board chip technology allows the operating status of the switch to be visible at a distance of at least 50 m.

### Technical specifications

Type	3SE7 120,	3SE7 150	3SE7 140	3SE7 160	3SE7 310
<b>Standards</b>	IEC 60947-5-1, EN 60947-5-1, IEC 60204-1, EN 60204-1				
<b>Approvals</b>	UL/CSA				
<b>Electrical design</b>	Contacts electrically isolated from each other				
<b>Electrical loading</b>	<ul style="list-style-type: none"> <li>• at AC-15 AC 400 V, 6 A</li> <li>• min. AC/DC 24 V, 10 mA</li> </ul>				
<b>Short-circuit protection</b>	6 A (slow)				
<b>Mechanical endurance</b>	> 1 × 10 <sup>6</sup> operating cycles				
<b>Contact material</b>	Fine silver				
<b>Actuation</b>	By pulling or breaking of rope				
<b>Rope length, maximum</b>	10 m	25 m	50 m	2 × 50 m	–
<b>Spacing between rope supports, maximum</b>	3 m	3 m	5 m	5 m	–
<b>Enclosure</b>	GD Al alloy, coated (color), dark black RAL 9005				
<b>Cover</b>	Shock-resistant thermoplastic				
<b>Degree of protection</b> acc. to IEC 60529	IP65				
<b>Ambient temperature</b>	–25 °C ... +70 °C				
<b>Fixing</b>	Designed for M 5				
<b>Fixing spacing</b>	30 mm and 40 mm				
<b>Cable entry</b>	2 × (M 20 × 1.5)	1 × (M 16 × 1.5)	2 × (M 25 × 1.5)	1 × (M 16 × 1.5)	2 × (M 25 × 1.5)
<b>Type of connection</b>	M3.5 screw connection, self-lifting terminal clamps				

# SIGUARD Cable-Operated Switches

## Metal enclosures

### Design

#### Mounting and fixing the cables

##### Short lengths of rope up to 25 m

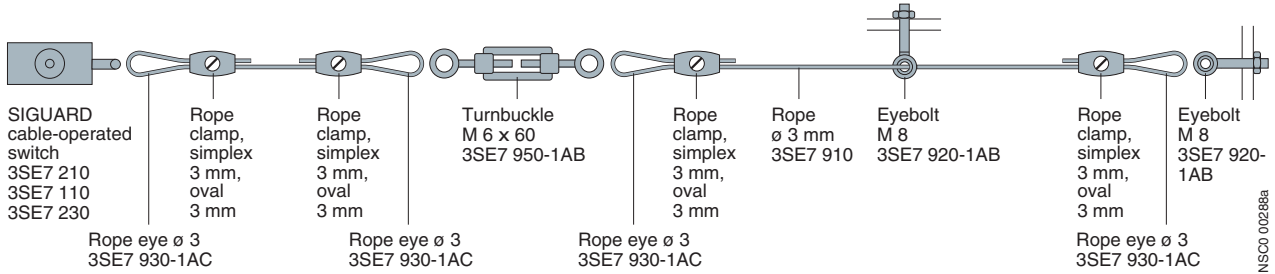

##### Long lengths of rope up to 50 m

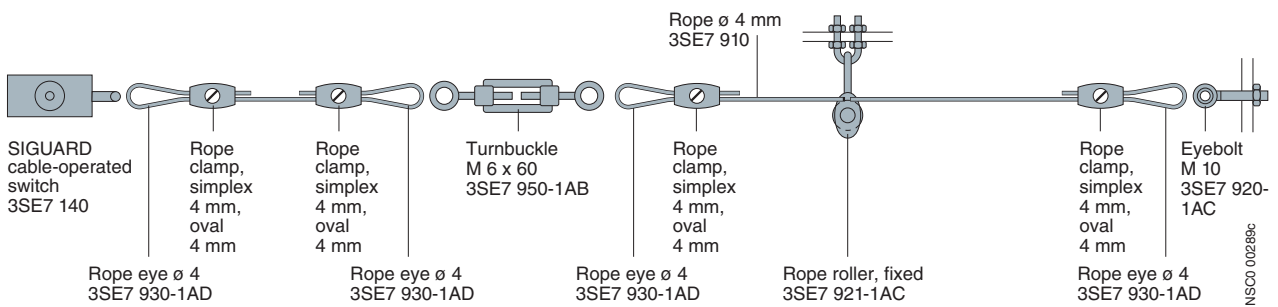

##### Pulling from both sides up to 2 x 50 m

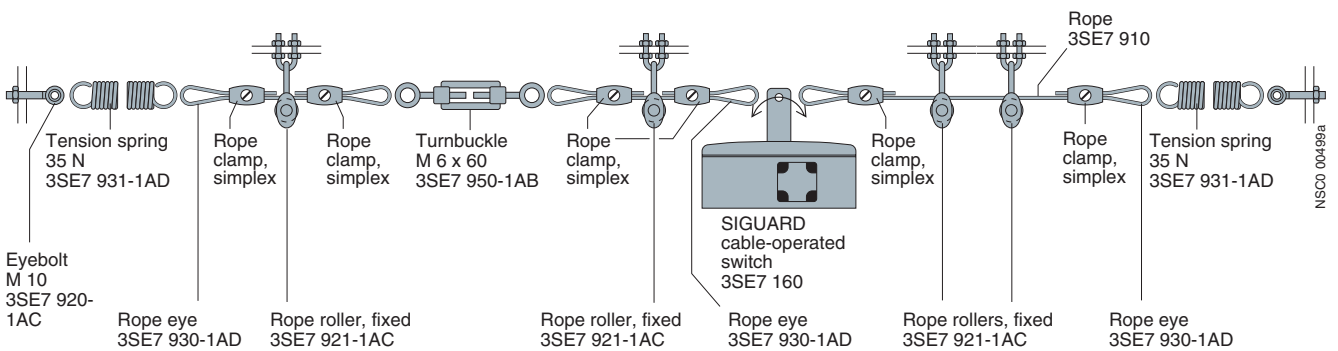







Use of a tension spring is essential for long sections of rope.

# SIGUARD Cable-Operated Switches

## Metal enclosures

### Selection and ordering data











Version	Rope length	Contacts	DT	Order No.	PS*	Weight per PU approx.	
	m					kg	
<b>Cable-operated switches</b>							
	<b>Metal enclosure</b> (cover made of molded plastic)	10					
		<ul style="list-style-type: none"> <li>without latching, only cable pull monitoring</li> <li>with latching and button reset</li> </ul>	1 NO + 1 NC	A	→ <b>3SE7 120-2DD01</b>	1 unit	0.425
		2 NC	A	→ <b>3SE7 120-1BF00</b>	1 unit	0.410	
	<b>Metal enclosure</b> (cover made of molded plastic), with dust protection and alignment window	25					
		<ul style="list-style-type: none"> <li>without latching</li> <li>with latching and button reset</li> </ul>	1 NO + 1 NC	C	→ <b>3SE7 150-2DD00</b>	1 unit	0.424
				1 NO + 1 NC	C	→ <b>3SE7 150-1BD00</b>	1 unit
		2 NC	C	→ <b>3SE7 150-1BF00</b>	1 unit	0.442	
		1 NO + 1 NC	C	→ <b>3SE7 150-1CD00</b>	1 unit	0.510	
	<b>Metal enclosure</b> (cover made of molded plastic), with dust protection, with LED, red, DC 24 V	25					
		<ul style="list-style-type: none"> <li>without latching</li> <li>with latching and button reset</li> </ul>	1 NO + 1 NC	A	→ <b>3SE7 150-2DD04</b>	1 unit	0.425
		1 NO + 1 NC	A	→ <b>3SE7 150-1BD04</b>	1 unit	0.448	
	<b>Metal enclosure</b> (cover made of molded plastic), with dust protection	50					
		<ul style="list-style-type: none"> <li>with latching and button reset</li> </ul>	1 NO + 1 NC	C	→ <b>3SE7 140-1BD00</b>	1 unit	0.792
				2 NC	C	→ <b>3SE7 140-1BF00</b>	1 unit
		1 NO + 1 NC	A	→ <b>3SE7 140-1BD04</b>	1 unit	0.820	
		1 NO + 1 NC	C	→ <b>3SE7 140-1CD00</b>	1 unit	0.835	
	<b>Metal enclosure</b> , with actuation on both sides	2 × 50					
		<ul style="list-style-type: none"> <li>with latching and button reset</li> <li>also with LED, red, DC 24 V</li> </ul>	2 NC + 2 NO	C	→ <b>3SE7 160-1AE00</b>	1 unit	1.270
		2 NC + 2 NO	A	→ <b>3SE7 160-1AE04</b>	1 unit	1.260	
<b>Conveyor belt unbalance protection devices</b>							
	<b>Metal enclosure</b>						
		<ul style="list-style-type: none"> <li>with latching and button reset</li> <li>also with LED, red, DC 24 V</li> </ul>	2 NC + 2 NO	C	→ <b>3SE7 310-1AE00</b>	1 unit	1.800
		2 NC + 2 NO	A	→ <b>3SE7 310-1AE04</b>	1 unit	1.810	
<b>Accessories</b>							
	<b>LED</b> , red DC 24 V 25 mm in diameter; for M 20 × 1.5 connection		A	<b>3SX3 235</b>	1 unit	0.019	

→ Positive opening according to IEC 60947-5-1, Appendix K.

# SIGUARD Cable-Operated Switches

## Metal enclosures

### Accessories

	Version	Length / diameter	DT	Order No.	PS*	Weight per PU approx. kg	
	<b>Steel rope</b> , with red plastic sheath, Ø 4 mm <sup>1)</sup>	10 m	A	<b>3SE7 910-3AA</b>	1 unit	0.422	
		15 m	A	<b>3SE7 910-3AB</b>	1 unit	0.600	
		20 m	A	<b>3SE7 910-3AC</b>	1 unit	0.863	
		50 m	A	<b>3SE7 910-3AH</b>	1 unit	2.120	
   	<b>Rope clamp</b> , galvanized white	• oval	Ø 4 mm	A	<b>3SE7 941-1AC</b>	1 unit	0.040
		• simplex (1 set = 4 units)	Ø 4 mm	A	<b>3SE7 943-1AC</b>	4 units	0.041
		• duplex (1 set = 4 units)	Ø 4 mm	A	<b>3SE7 944-1AC</b>	4 units	0.079
		• single (1 set = 4 units)	Ø 5 mm	A	<b>3SE7 942-1AA</b>	4 units	0.093
	<b>Tension springs</b> (zinc-plated) to maintain the counter tension	• 13 N	A	<b>3SE7 931-1AB</b>	1 unit	0.155	
		• 35 N	A	<b>3SE7 931-1AD</b>	1 unit	0.337	
	<b>Rope rollers</b> for changing the direction of the rope, rotatable	Ø 4 mm	A	<b>3SE7 921-1AC</b>	1 unit	0.046	
	<b>Fixing of the rope roller</b>		A	<b>3SE7 921-1AA</b>	1 unit	0.013	
	<b>Rope eyes</b> for changes in rope direction and improved power transmission at the fixing points (1 set = 4 units)	Ø 4 mm	A	<b>3SE7 930-1AD</b>	4 units	0.020	
	<b>Eyebolts</b> for fixing the rope	• incl. nut M 8	A	<b>3SE7 920-1AB</b>	1 unit	0.033	
		• incl. nut M 10	A	<b>3SE7 920-1AC</b>	1 unit	0.060	
	<b>Turnbuckle</b> for precise adjustment of the pretension	• M 6 × 60	A	<b>3SE7 950-1AB</b>	1 unit	0.051	
		• M 6 × 110	A	<b>3SE7 950-1AD</b>	1 unit	0.073	

1) Diameter including casing; the diameter of the steel wire is 3.2 mm.

### Dimension drawings

**3SE7 120-2DD..., 3SE7 150-2DD..**  
without latching

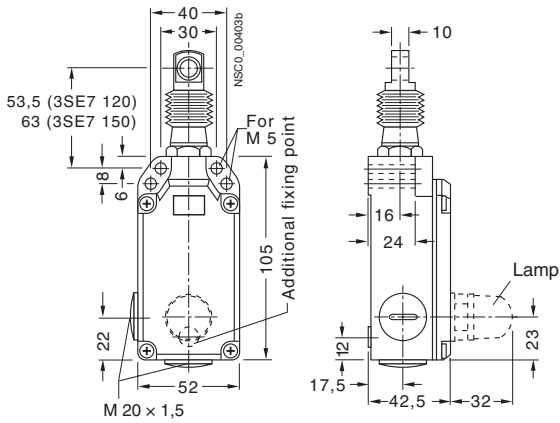

**3SE7 120-1B..., 3SE7 150-1B...**  
with latching and button reset

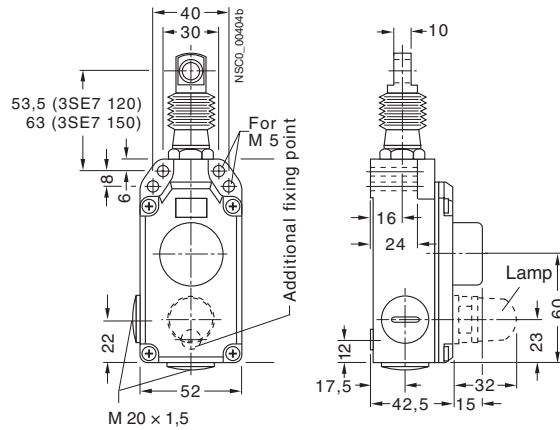

**3SE7 150-1CD..**  
with latching, button reset and key unlatching

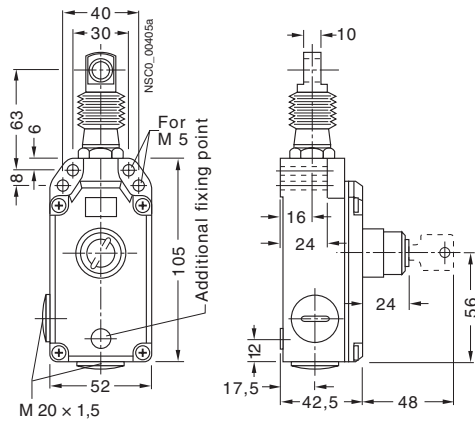

**3SE7 140-1B...**  
with latching and button reset

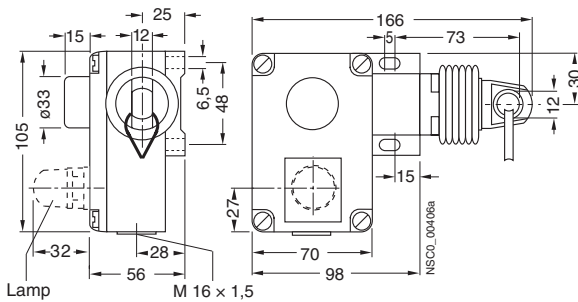

**3SE7 140-1CD..**  
with latching, button reset and key unlatching

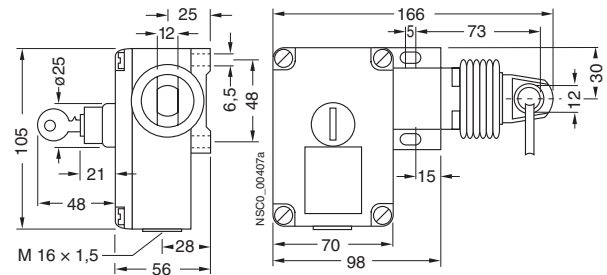

**3SE7 160-1AE..**  
with latching and button reset

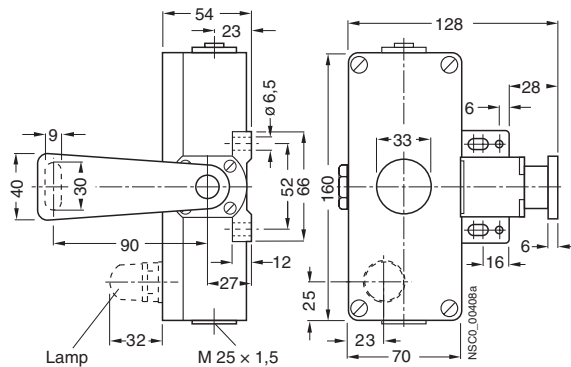

**Conveyor belt unbalance tracker 3SE7 310-1AE..**  
with latching and button reset

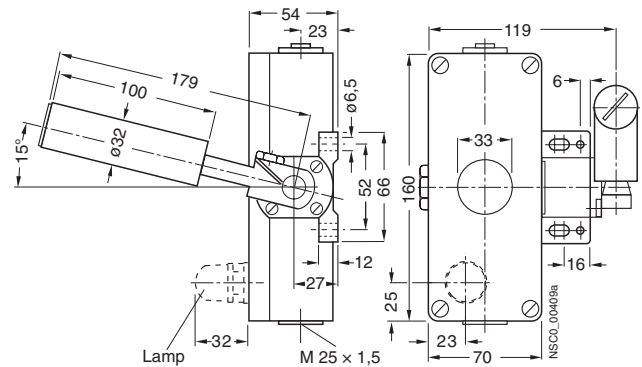

# SIGUARD Cable-Operated Switches

## Metal enclosures

### Circuit diagrams

#### Connection diagrams, operating travel diagrams

**3SE7 120-2DD01**

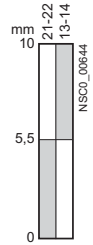

**3SE7 150-..D0.**

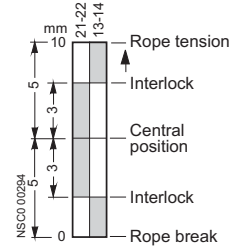

Central position

**3SE7 120-1BF00, 3SE7 150-1BF00**

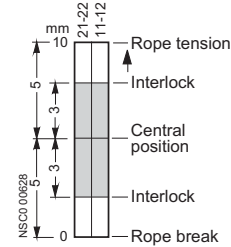

Central position

**3SE7 140-1.D0.**

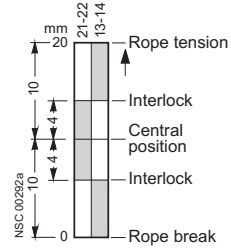

Central position

**3SE7 140-1.F00**

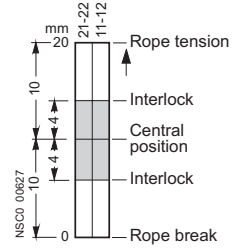

Central position

**3SE7 160-1AE, 3SE7 310-1AE**

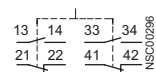
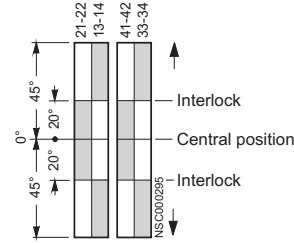

Central position



# SIGUARD Foot Switches

## Molded-plastic and metal enclosures

### Overview

The 3SE2 9 foot switch range encompasses versions in a metal enclosure for rugged applications as well as switches with molded-plastic enclosure. The sensors can be supplied with or without a cover.

Depending on the particular application, the switches can be ordered in latching or momentary-contact versions.

### Safety foot switches

The single-pedal SIGUARD safety foot switches to EN 418 lock on actuation. After eliminating the hazard, the machine can only be restarted after manually releasing the switch. A pushbutton

on the top of the enclosure is used for this purpose. The devices are supplied with a cover.

### Version with molded-plastic enclosure

For applications in less harsh environments, momentary-contact pedal switches with molded-plastic enclosures are available. They are supplied in single-pedal and two-pedal versions, the single-pedal version is also available with a cover. The momentary-contact pedal switch has one micro switch (changeover contact) per actuating pedal.

### Selection and ordering data

Version	Slow-action contacts for each pedal	DT	Order No.	PS*	Weight per PU approx. kg
<b>Metal enclosure, IP65 degree of protection</b>					
 3SE2 90.-.AA20, 3SE2 91.-.AA20	<b>Momentary-contact foot switch, single pedal</b> M 20 × 1.5 cable entry				
	• without cover	1 NO + 1 NC	A	→ <b>3SE2 902-0AB20</b>	1 unit 0.656
		2 NO + 2 NC	A	→ <b>3SE2 903-1AB20</b>	1 unit 0.669
	• with cover	1 NO + 1 NC	A	→ <b>3SE2 902-0AA20</b>	1 unit 1.340
		2 NO + 2 NC	A	→ <b>3SE2 903-1AA20</b>	1 unit 1.400
 3SE2 932-.AB20	<b>Foot switch, single-pedal</b> M 20 × 1.5 cable entry				
	• without cover	1 NO + 1 NC	C	→ <b>3SE2 912-2AB20</b>	1 unit 0.667
	• with cover	1 NO + 1 NC	C	→ <b>3SE2 912-2AA20</b>	1 unit 1.390
	 3SE2 932-.AA20	<b>Momentary-contact foot switch, two-pedal</b> M 25 × 1.5 cable entry			
• without cover		1 NO + 1 NC	B	→ <b>3SE2 932-0AB20</b>	1 unit 1.680
		2 NO + 2 NC	A	→ <b>3SE2 932-1AB20</b>	1 unit 1.680
	• with cover	1 NO + 1 NC	B	→ <b>3SE2 932-0AA20</b>	1 unit 2.990
		2 NO + 2 NC	B	→ <b>3SE2 932-1AA20</b>	1 unit 2.940
	<b>Safety foot switch, single-pedal</b> with cover, M 20 × 1.5 cable entry, with release button acc. to EN 418, NO closes as momentary contact type, NC opens with latching	2 NO + 2 NC	C	→ <b>3SE2 924-3AA20</b>	1 unit 1.460
<b>Molded-plastic enclosures, IP65 degree of protection</b>					
 3SE3 902-4CA20	<b>Foot switch, 3 m cable</b>		Microswitch		
	• one pedal				
	- without cover	1 CO	B	<b>3SE3 902-4CB20</b>	1 unit 0.341
	- with cover	1 CO	B	<b>3SE3 902-4CA20</b>	1 unit 1.100
 3SE3 934-5CB20	• two pedals, without cover	2 × 1 CO	B	<b>3SE3 934-5CB20</b>	1 unit 0.800

→ Positive opening according to IEC 60947-5-1, Appendix K.

\* This quantity or a multiple thereof can be ordered

# SIGUARD Foot Switches

## Molded-plastic and metal enclosures

### Dimension drawings

#### Metal enclosure

**3SE2 902-0AB20, 3SE3 903-1AB20,  
3SE2 912-2AB20**

Momentary contact foot switch/switch, one pedal,  
without cover

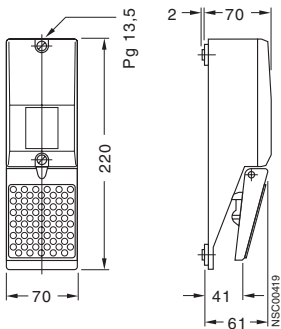

**3SE2 902-0AA20, 3SE3 903-1AA20,  
3SE2 912-2AA20**

Momentary contact foot switch/switch, one pedal,  
with cover

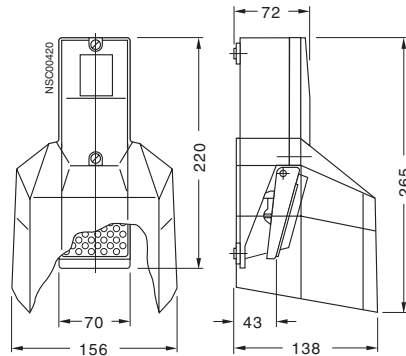

**3SE2 924-3AA20**  
Safety foot switch  
with release button

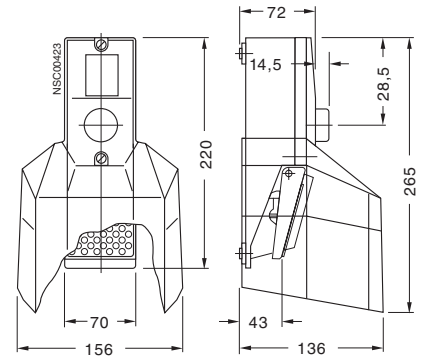

**3SE2 932-0AB20, 3SE2 932-1AB20**

Momentary contact foot switch, two pedals,  
without cover

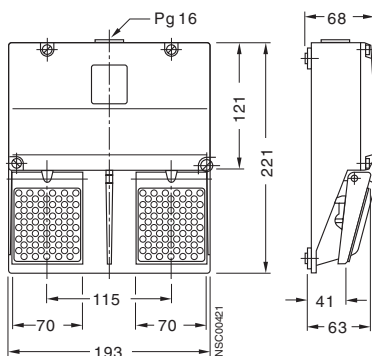

**3SE2 932-0AA20, 3SE2 932-1AA20**

Momentary contact foot switch, two pedals, with cover

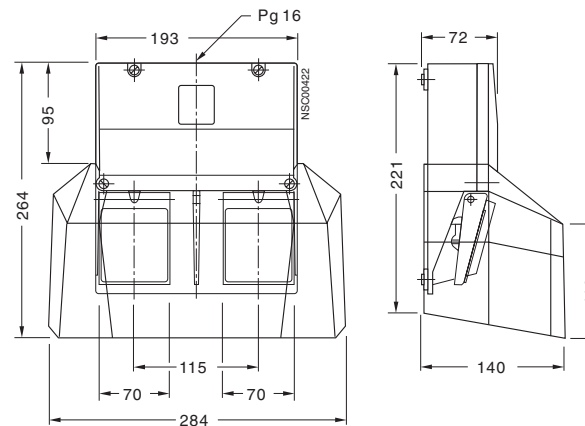

#### Molded-plastic enclosure

**3SE3 902-4CB20**

Momentary-contact foot switch, one pedal,  
without cover

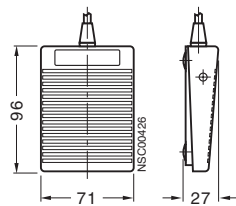

**3SE3 902-4CA20**

Momentary-contact foot switch, one pedal,  
with cover

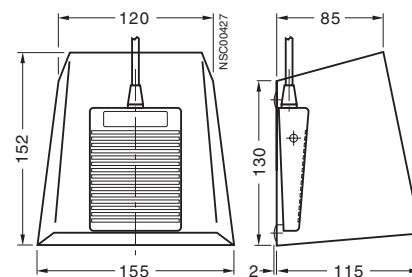

**3SE3 934-5CB20**

Momentary-contact foot switch, two pedals,  
without cover

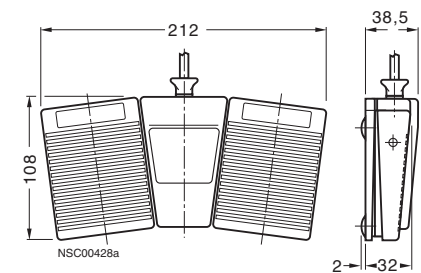

# SIGUARD Two-Hand Operation Consoles

## Molded-plastic and metal enclosures

### Area of application

SIGUARD two-hand operation consoles are required for use with machines and systems that have hazardous areas, in order to direct both hands of the operator to one position.

Operation consoles are primarily used on presses, stamping machines, printing presses and paper converting machines, in the chemical industry and in the rubber and plastics industries.

### Standards

The two-hand operation consoles comply with the requirements of EN 574.

### Design

#### Equipment

The two-hand operation consoles are pre-equipped with SIGNUM 3SB3 control devices. The standard equipment comprises:

- 2 black mushroom pushbuttons, Ø 40 mm, 1 NO + 1 NC, Order No. 3SB30 00-1GA11,
- 1 red EMERGENCY-STOP mushroom button, Ø 40 mm, with positive latching, 2 NC, Order No. 3SB30 00-1HA20.

The metal version is also available as an unequipped empty enclosure.

The molded-plastic version can be retrofitted with up to 8 customized command points. The surface of the console has pre-machined breaking points for this purpose.

### Installation



The two-hand operation consoles can be mounted either on the stand available or directly on the machine by means of the holes in the rear panel.

### Functions

The control command is given by pressing the two mushroom pushbuttons on the sides simultaneously (within 0.5 s of each other) and must be maintained for as long as a hazard exists.

For evaluation of the control commands, the associated 3TK28 34 press control units are offered as two-hand control units and the 3TK28 35 is offered as a slowing-down test apparatus in relay design (see [SIGUARD safety combinations](#)).

### Selection and ordering data

Version	DT	Order No.	PS*	Weight per PU approx. kg
 <p>3SB38 63-1BB</p> <p><b>Two-hand operation console, metal enclosure</b> IP65 degree of protection to EN 574</p> <ul style="list-style-type: none"> <li>• with standard equipment</li> <li>• with standard equipment and 4 additional holes for 22.5 mm control devices <sup>1)</sup></li> <li>• empty enclosure, unequipped</li> </ul> <p><b>Base plate for metal enclosure <sup>2)</sup></b></p>	B	<b>3SB38 63-3BB</b>	1 unit	3.970
	B	<b>3SB38 67-3BA</b>	1 unit	4.250
	B	<b>3SB38 63-3BC</b>	1 unit	4.130
	B	<b>3SB39 01-0AP</b>	1 unit	0.288
 <p>3SB39 01-0AQ</p> <p><b>Two-hand operation consoles, molded-plastic enclosures</b> with standard equipment and preset breaking points for 8 additional 22.5 mm command points <sup>1)</sup>, with holes for metric cable glands</p> <p><b>Stand for two-hand operation console</b> with cable entry holes for metric screwed cable glands</p>	B	<b>3SB38 63-1BB3</b>	1 unit	3.160
	B	<b>3SB39 01-0AQ3</b>	1 unit	16.000

1) See Section 9, SIGNUM control devices.

2) This is required when the metal enclosure is not mounted on the stand.

### Dimension drawings

#### 3SB38 63 operation console

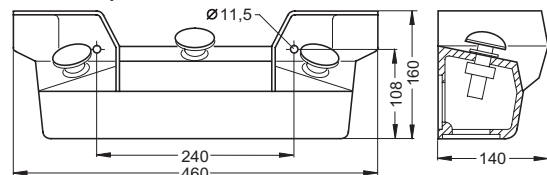

NSC00417

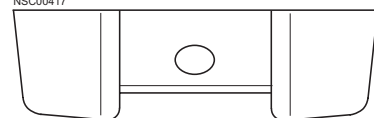

(metal version)

#### 3SB39 01-0AQ stand

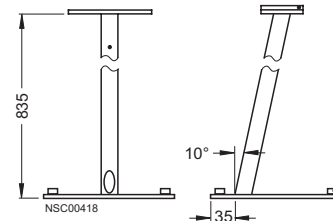

#### 3SB39 01-0AP metal base plate

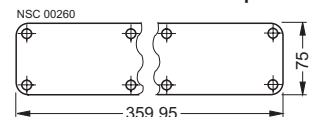

\* This quantity or a multiple thereof can be ordered

Siemens LV 10 · 2004

11/77

# SIGUARD Safety Combinations

## General data

### Area of application

#### Classification of a machine in categories acc. to EN 954-1

The 98/37/EG machinery directive stipulates that every machine must comply with the applicable guidelines and standards. Measures must be taken to keep the risk to persons below certain limits.

The first step is for the project engineer to perform a risk evaluation according to EN 1050 "Guidelines for risk assessment". The ambient conditions of the machine have to be considered, for example. Then any overall risk must be evaluated. Risk evaluation must be performed in such a manner that the procedure

and conclusions can be retraced. The dangers and possible technical measures for reducing risk must also be specified.

After risk assessment, the category according to which the safety circuits will be designed and implemented is specified with the aid of EN 954-1.

This category defines the technical requirements for the configuration of the safety equipment. There are five categories (B, 1, 2, 3 and 4), whereby B (for Basic category) is the category of the lowest risk and the one which defines the minimum demands made on the control system.

#### Possible selection of the categories according to EN 954-1

Starting point for risk assessment of the safety related part of the control	S Severity of the injury	F Frequency and/or duration of the exposure to danger	P Possibility to avoid the danger
	S1 Minor (usually reversible) injury	F1 From rarely to often and/or short duration of exposure	P1 Possible under certain conditions
	S2 Serious (normally irreversible) injury including death	F2 From frequently to constantly and/or long duration of exposure	P2 Hardly possible

#### Selection of the category

B, 1 to 4: Categories for parts of controllers with relevance for safety

- Preferred categories for reference points
- Possible categories which demand additional measures
- Measures that may be excessive with respect to the particular risk

#### Summary of the requirements for categories acc. to EN 954-1

Category <sup>1)</sup>	Summary of requirements	System response <sup>2)</sup>	Principles for achieving safety
B	The safety related parts of controllers and/or their protective devices as well as their components must be designed, constructed, selected, assembled and combined in accordance with the applicable standards in such a way that they can resist the expected external influences.	The occurrence of a fault can result in loss of the safety function.	Mainly characterized by the selection of components
1	The requirements of B must be met. Well-proven components and well-proven safety principles must be implemented.	The occurrence of a fault can result in loss of the safety function but the probability of it occurring is less than for Category B.	
2	The requirements of B must be met and well-proven safety principles must be implemented. The safety functions must be tested at regular intervals by the machine control.	The occurrence of a fault can result in loss of the safety function between tests. The loss of the safety function will be detected by the test.	Mainly characterized by the structure
3	The requirements of B must be met and well-proven safety principles must be implemented. Parts with relevance for safety must be implemented such that: a single fault in any of these components does not result in loss of the safety function, and whenever reasonably possible, the individual fault is detected.	When the single fault occurs, the safety function is always maintained. Some but not all faults are detected. An accumulation of undetected faults may lead to loss of the safety function.	
4	The requirements of B must be met and well-proven safety principles must be implemented. Parts with relevance for safety must be implemented such that: A single fault in any of these components does not result in loss of the safety function. The individual fault is detected during or before the next activation of the safety function or, if this is not possible, an accumulation of faults will not result in loss of the safety function.	When faults occur, the safety function is always maintained. The faults are detected early to prevent loss of the safety function.	

1) The categories are not intended to be applied in a specific sequence or hierarchy with reference to the safety requirements.

2) The risk assessment will establish whether complete or partial loss of the safety function(s) due to faults is acceptable.

### Standards for "Safety of machines"

- EN 60204-1 "Electrical equipment of industrial machines"
- EN 418 "EMERGENCY-STOP equipment, functional aspects, basic design principles"
- EN 574 "Two-hand switching"
- EN 954-1 "Safety-related parts of controls"
- EN 1050 "Guidelines for risk assessment"
- EN 1088 "Locking facilities in combination with isolating protective devices"
- IEC 61508 "Functional safety of electrical/programmable solid-state safety related systems"

### Stop categories

Potential dangers posed by a machine must be eliminated as quickly as possible.

As a rule, the "danger-free status" is standstill with respect to hazardous motions. All SIGUARD safety combinations are de-energized in the event of danger or a fault, i.e. the machine drives are switched to standstill. The EN 60204 standard requires that every machine must be equipped with the Stop function of Category 0. Stop functions of Categories 1 and/or 2 must be implemented when this is necessary for the safety and/or functional requirements of the machine.

There are 3 categories of Stop functions:

- Stop category 0:  
Shutdown by immediate switch-off of the energy infeed to the machine drives.
- Stop category 1:  
Controlled shutdown, whereby the energy infeed to the machine drives is maintained during shutdown and is only switched off when standstill has been achieved.
- Stop category 2:  
Controlled shutdown, whereby the energy infeed to the machine drives is maintained.

The devices support autostart or monitored start depending on their versions.

### Autostart

The device is active when the sensor circuit is closed. If the ON button is connected in the feedback circuit, this will not be monitored for crossover. Crossover monitoring is not required by EN 954-1 for Categories B, 1, 2 and 3.

If an autostart device is used for Category 4 and EMERGENCY-STOP, the user must ensure that faults are prevented (e.g. by safe routing of the ON pushbutton lead) in the ON pushbutton circuit.

### Monitored start

A safety combination is activated following power supply failure or safety-related shutdown by pressing the ON button.

For Category 4 in accordance with EN 954-1, it is necessary that the ON/feedback circuit is monitored for crossover.

The ON button must be operated after connecting the sensor lead.

### Crossover protection

Crossover protection is the ability of the safety combination to detect faults (e.g. through cable compression or ground faults) in the safety chain to be monitored and to suppress the enabling of the enabling circuits until the external fault has been rectified.

### EMERGENCY-STOP

EMERGENCY-STOP devices must have priority over all other functions.

The energy infeed to the machine drives that can cause dangerous situations must be switched off as quickly as possible without causing any further danger. Resetting of the drives must not result in restarting of the equipment. EMERGENCY-STOP must either function as a Stop of Category 0 or Category 1.

Resetting of the command device must only be possible as a result of a manual action on the command device. Resetting of the command device must not initiate a restart command. Restarting of the machine must not be possible until all actuated operator controls have been reset deliberately and individually by hand (EN 418).

The basic units of the SIGUARD combinations can be used for EMERGENCY-STOP applications up to Category 4 of EN 954-1. Category 3 or 4 of EN 954-1 or SIL 2/3 (Safety Integrity Level) to IEC 61508 must be achieved depending on the external circuit and routing of the sensor leads.

### Protective door monitoring

EN 1088 distinguishes between interlocked, isolating protection devices and interlocked, isolating protective devices with tumbler.

SIGUARD combinations are also used in this case for EMERGENCY-STOP applications. Control systems for up to Category 4 of EN 954-1 or SIL 2/3 of IEC 61508 are possible.

### Presses and punches

The two-hand control unit is a device that requires both hands of the operator to be used simultaneously as a means of protecting the operator from danger.

The slowing down test apparatus is used with linearly driven presses (e.g. hydraulic, pneumatic and spindle presses) according to VBG 7n5.2. It only tests once on the test stroke for:

- Correct connection of the control elements
- External cable interruption
- Any failure of the cyclically monitored components

The slowing down test apparatus can only be implemented in conjunction with a two-hand control unit.

The press control units and the slowing down test apparatus are suitable for installation in control systems for eccentric, hydraulic and screw presses. They can be used up to Category 4 of EN 954-1. Type III C to EN 574 is possible specifically for presses.

# SIGUARD Safety Combinations

## Relay safety combinations

### Overview

The SIGUARD safety pilot guides you quickly to the right device

Type	1-channel connection	2-channel connection	Crossover protection	Category according to EN 954-1 <sup>1)</sup>				EMERGENCY-STOP	Protective door	Enabling contacts	Signaling contacts	Autostart	Monitored start	
				B	1	2	3							4
<b>Basic units</b>														
3TK28 21	✓	☐	☐	✓	✓	✓	✓	☐	✓ <sup>2)</sup>	✓	3 NO	1 NC	✓	-
3TK28 22	-	✓	✓	✓	✓	✓	✓	✓	✓ <sup>2)</sup>	✓	2 NO	-	✓	-
3TK28 23	-	✓	✓	✓	✓	✓	✓	✓	✓ <sup>3)</sup>	✓	2 NO	-	-	✓
3TK28 24	✓	☐	☐	✓	✓	✓	✓	☐	✓ <sup>2)</sup>	✓	2 NO	-	✓	-
3TK28 25	✓	✓	✓	✓	✓	✓	✓	✓	✓	✓	3 NO	2 NC	✓	✓
3TK28 27	✓	✓	✓	✓	✓	✓	✓	✓ <sup>4)</sup>	✓	✓ <sup>3)</sup>	2 NO + 2 NC, delayed	1 NC	-	✓
3TK28 28	✓	✓	✓	✓	✓	✓	✓ <sup>4)</sup>	✓ <sup>2)</sup>	✓	✓	2 NO + 2 NC, delayed	1 NC	✓	-
<b>Expansion units</b>														
3TK28 30 <sup>5)</sup>	-	-	-	✓	✓	✓	✓	✓	-	-	4 NO	-	-	-
<b>Press control devices</b>														
3TK28 34	-	✓	✓	✓	✓	✓	✓	✓ <sup>6)</sup>	-	-	2 NO + 2 NC	-	-	-
3TK28 35 <sup>7)</sup>	-	-	-	✓	✓	✓	✓	✓ <sup>6)</sup>	-	-	3 NO + 1 NC	-	-	-

✓ = available

☐ = available, at additional cost

- = not available

1) The maximum achievable category according to EN 954-1 is dependent on the external circuit, the choice of sensors and the physical arrangement on the machine. Compliance with the standards and regulations for safety at the machine is essential.

2) The ON button is not monitored.

3) Possible with monitored ON button.

4) Only possible for instantaneous enabling contacts.

5) The category according to EN 954-1 is the category of the basic unit.

6) According to EN 574, Type III C.

7) Only in conjunction with the two-hand control unit.

### Design

Contact safety combinations 3TK28 21 to 28 and 3TK28 30, 34 and 35 operate with internal contactor relays with positively-driven contacts. The contacts of the switching devices comply with the requirement for positively driven operation laid down in ZH 1/457, Edition 2, 1978. NO and NC contacts are not allowed to be closed at the same time.

In a redundant circuit, operation of the internal switching devices is monitored. If a contactor or safety relay fails, the safety combination will always switch to the de-energized and consequently safe state. The fault is detected and the safety combination can no longer be switched on. The use of NO and NC contacts for the same function satisfies the demand for diversity.

This product series is characterized by its space-saving width (22.5 mm or 45 mm). The usual BIA, BG and SUVA approvals and test certificates have been awarded.

#### Enabling contacts (FK)

Safety related operation must be performed by safe output contacts, known as enabling contacts. Enabling contacts are always NO contacts and switch without delay.

#### Signaling contacts (MK)

NC contacts are used as signaling contacts but they are not permitted to perform functions with relevance for safety. An enabling contact can also be used as a signaling contact. A signaling contact cannot, however, be used as an enabling contact.

#### Delayed enabling contacts

Machine drives that overrun for a long time must be externally braked in the event of danger. For this purpose, the power supply for electrical braking can be maintained (Stop Category 1 acc. to EN 60204-1).

The basic units have off-delay enabling contacts in addition to instantaneous enabling contacts. Time delays of between 0.5 and 30 s are available with the different versions. A 3RP19 02 sealable covering cap (see Selection and ordering data, accessories) can be fitted to protect against unauthorized adjustment of the set delay time.

#### Expansion units

If the enabling contacts of the basic unit are inadequate, expansion units can be used. An expansion unit has 4 enabling contacts.

Expansion units are not allowed to be operated separately in safety-related switching circuits; they must be combined with a basic unit. One enabling contact of the basic unit is required for connecting an expansion unit. The category of a control system with expansion unit corresponds to that of the basic unit.

#### Installation

The equipment is designed for snap-mounting on a 35 mm mounting rail to EN 50022. Screw fixing is also possible for the devices by means of 2 additional 3RP19 03 push-in lugs.



### Technical specifications

Type		3TK28 21	3TK28 22	3TK28 23	3TK28 24	3TK28 30	3TK28 25	3TK28 27, 3TK28 28	3TK28 34	3TK28 35		
<b>Standards</b>		IEC 60204-1, EN 60204-1, EN 292, EN 954-1							Also EN 574			
<b>Test certificates</b>		BG, SUVA, UL, CSA										
<b>Category</b> • acc. to EN 954-1 • acc. to EN 574		4 <sup>1)</sup> –	4 –	4 –	4 <sup>1)</sup> –	as basic unit	4 –	4 <sup>2)</sup> –	4 Type III C	as basic unit		
<b>Rated insulation voltage <math>U_i</math></b>	V	300										
Pollution degree		3										
Overvoltage category acc. to EN 60664		III										
<b>Rated impulse withstand voltage <math>U_{imp}</math></b>	kV	4										
<b>Rated power of coils</b> DC/AC operation at $1.0 \times U_s$	W	1.5						3	4	3		
<b>Operating range of the coils</b> • AC operation • DC operation		0.85 ... $1.1 \times U_s$ 0.85 ... $1.2 \times U_s$				0.85 ... $1.1 \times U_s$ 0.85 ... $1.1 \times U_s$						
<b>Continuous thermal current <math>I_{th}</math></b>	A	5						6	5	6	5	
<b>Continuous thermal current <math>I_{th}</math></b> for 2 to 4 enabling contacts (FK)		2 FK		3 FK	4 FK							
• at AT 70 °C	A	4		3.5	3		5 A	4 A	5 A	4 A		
• at AT 60 °C	A	4.5		4	3.5		6 A	5 A	6 A	5 A		
• at AT 50 °C	A	5		4.5	4		6 A	5 A	6 A	5 A		
<b>Rated operating current <math>I_e</math></b> acc. to IEC 60947-1												
• $I_e$ / AC-15	at 115 V	A	5						6	5 / 2 <sup>5)</sup>	6	5 / 2 <sup>6)</sup>
	at 230 V	A	5						6	5 / 2 <sup>5)</sup>	6	5 / 2 <sup>6)</sup>
• $I_e$ / DC-13	at 24 V	A	5						6	5 / 2 <sup>5)</sup>	6	5 / 2 <sup>6)</sup>
<b>Short-circuit protection</b> (weld-free protection at $I_k = 1 \text{ kA}$ ) <sup>4)</sup>		Fuse inserts LV HRC Type 3NA, DIAZED Type 5SB, NEOZED Type 5SE: 6 A Operational class gL/gG 6 A (slow), quick 10 A <sup>3)</sup>										
<b>Mechanical endurance</b>		10 million operating cycles										
<b>Electrical endurance at <math>I_e</math></b>		100 000 operating cycles										
<b>Operating frequency</b>		1000/h on loading with $I_e$										
<b>Response time</b>	ms											
• monitored start	ms	–			≤ 30		–	≤ 30 <sup>9)</sup>	–	≤ 100	≤ 50	
• Autostart	ms	≤ 200 <sup>7)</sup>			≤ 100		–	≤ 25	≤ 80	–	–	
							–	≤ 150	≤ 80	–	–	
							–	–	–	–	–	
<b>Release time</b>	ms											
• for EMERGENCY-STOP	ms	≤ 200	≤ 80	≤ 20	≤ 200	–	≤ 25	≤ 25	≤ 20	≤ 50		
• for supply failure	ms	≤ 200	≤ 100	≤ 150	≤ 200	≤ 25 <sup>10)</sup>	≤ 350	≤ 100	–	–		
<b>Recovery time</b>	ms											
• for EMERGENCY-STOP	ms	≥ 200	≥ 200	≥ 400	≥ 200	–	≥ 200	After time has elapsed ≥ 1 s	≥ 250	≥ 250		
• for supply failure	ms	≥ 200	≥ 200	≥ 600	≥ 200	≥ 100	≥ 500	–	–	–		
<b>Bridging of supply failures</b>	ms	60	30	80	60	35	100	30	40	40		
<b>Minimum command duration</b>	ms											
• EMERGENCY-STOP	ms	≥ 200	≥ 25	≥ 25	≥ 200 <sup>8)</sup>	–	≥ 25	≥ 25	–	–		
• ON button	ms	≥ 150	≥ 40	≥ 25	≥ 150 <sup>8)</sup>	–	≥ 25	≥ 25	–	–		
<b>Simultaneity</b>	ms	∞							500			
<b>Conductor cross-sections</b>												
Screw terminals												
• Finely stranded with end sleeve	mm <sup>2</sup>	2 x (0.5 ... 1.5), 1 x (0.5 ... 2.5)										
• Solid	mm <sup>2</sup>	2 x (0.5 ... 2.5), 1 x (0.5 ... 4)										
• Tightening torque, M 3.5 screw	Nm	0.8 ... 1.2										
Spring-loaded terminals		(1 or 2 conductors can be connected)										
• Solid	mm <sup>2</sup>	2 x (0.25 ... 1.5)										
• Finely stranded with end sleeve	mm <sup>2</sup>	2 x (0.25 ... 1.0)										
• Finely stranded without end sleeve	mm <sup>2</sup>	2 x (0.25 ... 1.5)										
• AWG conductor, solid or stranded	mm <sup>2</sup>	2 x AWG 24 ... 16										
<b>Permissible ambient temperature</b>	°C	–25 ... +60 (suitable for butt-mounting; 70 °C possible with restrictions)										
• in operation	°C	–40 ... +80										
• when stored												
<b>Degree of protection</b> acc. to EN 60529		IP40					IP20					
• enclosure		IP20					IP20					
• terminals												
<b>Touch protection</b> acc. to VDE 0106		Finger-safe										
<b>Resistance to shock</b> , half-sine to IEC 60068		8 g/10 ms										
<b>Permissible mounting position</b>		Any										





For footnotes, see page 11/82.

# SIGUARD Safety Combinations

## Relay safety combinations

### Selection and ordering data

Rated control supply voltage  $U_S$  DC 24 V and AC 50/60 Hz, 24, 115, 230 V

	Enabling contacts <sup>1)</sup>	Signaling contacts	Max. achievable category acc. to EN 954-1 <sup>2)</sup>	Rated control supply voltage $U_S$ V	DT	With screw terminals	PS*	Weight per PU approx. kg	DT	With spring-loaded terminals	PS*	Weight per PU approx. kg	
						Order No.				Order No.			
<b>Basic units for EMERGENCY-STOP and protective doors</b>													
	<b>Autostart</b>												
	3 NO	1 NC	B, 1, 2, 3, 4 <sup>3)</sup>	AC/DC 24	▶	<b>3TK28 21-1CB30</b>	1 unit	0.276	▶	<b>3TK28 21-2CB30</b>	1 unit	0.246	
	2 NO	–	B, 1, 2, 3, 4	AC/DC 24	▶	<b>3TK28 22-1CB30</b>	1 unit	0.271	▶	<b>3TK28 22-2CB30</b>	1 unit	0.250	
	<b>Monitored start</b>												
	2 NO	–	B, 1, 2, 3, 4	AC/DC 24	▶	<b>3TK28 23-1CB30</b>	1 unit	0.274	▶	<b>3TK28 23-2CB30</b>	1 unit	0.247	
	<b>Autostart</b>												
2 NO	–	B, 1, 2, 3, 4 <sup>3)</sup>	AC/DC 24	▶	<b>3TK28 24-1CB30</b>	1 unit	0.254	▶	<b>3TK28 24-2CB30</b>	1 unit	0.230		
2 NO	–	B, 1, 2, 3, 4 <sup>3)</sup>	DC 24	▶	<b>3TK28 24-1BB40</b>	1 unit	0.249	▶	<b>3TK28 24-2BB40</b>	1 unit	0.228		
2 NO	–	B, 1, 2, 3, 4 <sup>3)</sup>	AC 115	▶	<b>3TK28 24-1AJ20</b>	1 unit	0.294	C	<b>3TK28 24-2AJ20</b>	1 unit	0.240		
2 NO	–	B, 1, 2, 3, 4 <sup>3)</sup>	AC 230	▶	<b>3TK28 24-1AL20</b>	1 unit	0.288	C	<b>3TK28 24-2AL20</b>	1 unit	0.270		
	<b>Autostart/monitored start</b>												
	3 NO	2 NC	B, 1, 2, 3, 4	DC 24	▶	<b>3TK28 25-1BB40</b>	1 unit	0.420	▶	<b>3TK28 25-2BB40</b>	1 unit	0.374	
	3 NO	2 NC	B, 1, 2, 3, 4	AC 24	▶	<b>3TK28 25-1AB20</b>	1 unit	0.421	▶	<b>3TK28 25-2AB20</b>	1 unit	0.375	
	3 NO	2 NC	B, 1, 2, 3, 4	AC 115	▶	<b>3TK28 25-1AJ20</b>	1 unit	0.519	▶	<b>3TK28 25-2AJ20</b>	1 unit	0.472	
	3 NO	2 NC	B, 1, 2, 3, 4	AC 230	▶	<b>3TK28 25-1AL20</b>	1 unit	0.516	▶	<b>3TK28 25-2AL20</b>	1 unit	0.475	
	<b>Monitored start</b>												
	2 NO+2 NO	1 NC	B, 1, 2, 3, 4 <sup>4)</sup>	DC 24	▶	<b>3TK28 27-1BB40</b>	1 unit	0.497	▶	<b>3TK28 27-2BB40</b>	1 unit	0.455	
	2 NO+2 NO	1 NC	B, 1, 2, 3, 4 <sup>4)</sup>	AC 24	▶	<b>3TK28 27-1AB20</b>	1 unit	0.496	▶	<b>3TK28 27-2AB20</b>	1 unit	0.454	
	2 NO+2 NO	1 NC	B, 1, 2, 3, 4 <sup>4)</sup>	AC 115	▶	<b>3TK28 27-1AJ20</b>	1 unit	0.650	▶	<b>3TK28 27-2AJ20</b>	1 unit	0.606	
	2 NO+2 NO	1 NC	B, 1, 2, 3, 4 <sup>4)</sup>	AC 230	▶	<b>3TK28 27-1AL20</b>	1 unit	0.650	▶	<b>3TK28 27-2AL20</b>	1 unit	0.604	
	Off-delay, $t_V = 0.5 \dots 30$ s												
	<b>Monitored start</b>												
2 NO+2 NO	1 NC	B, 1, 2, 3, 4 <sup>4)</sup>	DC 24	▶	<b>3TK28 27-1BB41</b>	1 unit	0.495	▶	<b>3TK28 27-2BB41</b>	1 unit	0.454		
2 NO+2 NO	1 NC	B, 1, 2, 3, 4 <sup>4)</sup>	AC 24	C	<b>3TK28 27-1AB21</b>	1 unit	0.499	▶	<b>3TK28 27-2AB21</b>	1 unit	0.454		
2 NO+2 NO	1 NC	B, 1, 2, 3, 4 <sup>4)</sup>	AC 115	C	<b>3TK28 27-1AJ21</b>	1 unit	0.645	C	<b>3TK28 27-2AJ21</b>	1 unit	0.240		
2 NO+2 NO	1 NC	B, 1, 2, 3, 4 <sup>4)</sup>	AC 230	C	<b>3TK28 27-1AL21</b>	1 unit	0.652	C	<b>3TK28 27-2AL21</b>	1 unit	0.605		
Off-delay, $t_V = 0.05 \dots 3$ s													
	<b>Autostart</b>												
	2 NO+2 NO	1 NC	B, 1, 2, 3, 4 <sup>4)</sup>	DC 24	▶	<b>3TK28 28-1BB40</b>	1 unit	0.496	▶	<b>3TK28 28-2BB40</b>	1 unit	0.457	
	2 NO+2 NO	1 NC	B, 1, 2, 3, 4 <sup>4)</sup>	AC 24	▶	<b>3TK28 28-1AB20</b>	1 unit	0.500	C	<b>3TK28 28-2AB20</b>	1 unit	0.468	
	2 NO+2 NO	1 NC	B, 1, 2, 3, 4 <sup>4)</sup>	AC 115	C	<b>3TK28 28-1AJ20</b>	1 unit	0.653	C	<b>3TK28 28-2AJ20</b>	1 unit	0.609	
	2 NO+2 NO	1 NC	B, 1, 2, 3, 4 <sup>4)</sup>	AC 230	C	<b>3TK28 28-1AL20</b>	1 unit	0.650	C	<b>3TK28 28-2AL20</b>	1 unit	0.612	
	Off-delay, $t_V = 0.5 \dots 30$ s												
	<b>Autostart</b>												
	2 NO+2 NO	1 NC	B, 1, 2, 3, 4 <sup>4)</sup>	DC 24	▶	<b>3TK28 28-1BB41</b>	1 unit	0.499	▶	<b>3TK28 28-2BB41</b>	1 unit	0.450	
	2 NO+2 NO	1 NC	B, 1, 2, 3, 4 <sup>4)</sup>	AC 24	▶	<b>3TK28 28-1AB21</b>	1 unit	0.501	C	<b>3TK28 28-2AB21</b>	1 unit	0.454	
	2 NO+2 NO	1 NC	B, 1, 2, 3, 4 <sup>4)</sup>	AC 115	C	<b>3TK28 28-1AJ21</b>	1 unit	0.650	C	<b>3TK28 28-2AJ21</b>	1 unit	0.240	
	2 NO+2 NO	1 NC	B, 1, 2, 3, 4 <sup>4)</sup>	AC 230	C	<b>3TK28 28-1AL21</b>	1 unit	0.650	C	<b>3TK28 28-2AL21</b>	1 unit	0.608	
	Off-delay, $t_V = 0.05 \dots 3$ s												

For multi-unit/reusable packaging, see Appendix.

- 1) Enabling contacts are contacts with relevance for safety that can also be used as signaling contacts.
- 2) The maximum achievable category acc. to EN 954-1 is the category of the basic unit. The category also depends on the external circuit, the command device selected and their location on the machine. Compliance with the standards and regulations for safety at the machine is essential.
- 3) Possible if external measures are implemented. The specifications are only applicable if the wires and sensors are reliably connected and mechanically protected. See operating instructions and applications manual as well.
- 4) Only applicable to the instantaneous enabling contacts.

### Footnotes for page 11/81:



- 1) Possible if external measures are implemented. The specifications are only applicable if the wires and sensors are reliably connected and mechanically protected. See operating instructions and applications manual as well.
- 2) Only applicable for instantaneous enabling contacts; Category 3 applies for time-delayed contacts.
- 3) Signaling circuit for 3TK28 21 = 6 A.
- 4) Other fuses on request.
- 5) Instantaneous / time-delayed enabling contacts.
- 6) 2 A applies to enabling contacts 13/14.
- 7) At AC 24 V: 300 ms.
- 8) At AC 115, 230 V: 300 ms.
- 9) At AC 115, 230 V: max. 200 ms.
- 10) At AC 115, 230 V: max. 80 ms.



# SIGUARD Safety Combinations

## Relay safety combinations

Rated control supply voltage  $U_S$  DC 24 V and AC 50/60 Hz, 24, 115, 230 V



Enabling contacts <sup>1)</sup>	Signaling contacts	Max. achievable category acc. to EN 954-1 <sup>2)</sup>	Rated control supply voltage $U_S$	DT	With screw terminals	PS*	Weight per PU approx.	DT	With spring-loaded terminals	PS*	Weight per PU approx.
			V		Order No.		kg		Order No.		kg
<b>Expansion units</b>											
<b>For expansion of the contacts of the safety combinations</b> (for connecting to the basic unit, 1 enabling contact of the basic unit is required)											
	4 NO	– <sup>3)</sup>	as basic unit	AC/DC 24	▶ 3TK28 30-1CB30	1 unit	0.274	A	▶ 3TK28 30-2CB30	1 unit	0.249
	4 NO	– <sup>3)</sup>	as basic unit	AC 115	B 3TK28 30-1AJ20	1 unit	0.306	B	▶ 3TK28 30-2AJ20	1 unit	0.276
	4 NO	– <sup>3)</sup>	as basic unit	AC 230	B 3TK28 30-1AL20	1 unit	0.306	B	▶ 3TK28 30-2AL20	1 unit	0.276
<b>Press control devices</b>											
<b>for use in presses and punches</b>											
<b>Two-hand control unit, two-channel</b>											
	2 NO	2 NC	4	DC 24	▶ 3TK28 34-1BB40	1 unit	0.419	▶	▶ 3TK28 34-2BB40	1 unit	0.383
	2 NO	2 NC	4	AC 24	▶ 3TK28 34-1AB20	1 unit	0.424	▶	▶ 3TK28 34-2AB20	1 unit	0.376
	2 NO	2 NC	4	AC 115	▶ 3TK28 34-1AJ20	1 unit	0.519	▶	▶ 3TK28 34-2AJ20	1 unit	0.472
	2 NO	2 NC	4	AC 230	▶ 3TK28 34-1AL20	1 unit	0.519	▶	▶ 3TK28 34-2AL20	1 unit	0.472
<b>Slowing down test apparatus<sup>4) 5)</sup></b>											
	3 NO	1 NC		DC 24	▶ 3TK28 35-1BB40	1 unit	0.495	▶	▶ 3TK28 35-2BB40	1 unit	0.455
	3 NO	1 NC		AC 24	▶ 3TK28 35-1AB20	1 unit	0.476	C	▶ 3TK28 35-2AB20	1 unit	0.454

For multi-unit/reusable packaging, see Appendix.

- 1) Enabling contacts are contacts with relevance for safety that can also be used as signaling contacts.
- 2) The maximum achievable category acc. to EN 954-1 is the category of the basic unit.
- 3) Feedback circuit with NC contact 51 + 52.

4) The 3TK28 35 slowing down test apparatus can only be used in conjunction with the 3TK28 34 two-hand control unit.

5) Other voltages on request.

Version	DT	Order No.	PS*	Weight per PU approx.
				kg
<b>Accessories</b>				
		▶ 3RP19 02	5 units	0.004
to secure against unauthorized adjustment, for 3TK28 27 and 3TK28 28 devices				
		▶ 3RP19 03	10 units	0.002
for 3TK28 21 to 3TK28 35 devices (1 set = 2 units)				
		▶ 3RP1505-1RW30	1 unit	0.163
Time relay with positively-driven contacts Positively driven contacts to EN 50205				

For further information and technical specifications for the time relay, see Section 8.

# SIGUARD Safety Combinations

## Relay safety combinations

### Dimension drawings

#### SIGUARD 3TK28 safety combinations (relay type) with screw terminals

3TK28 21 to 3TK28 24, 3TK28 30

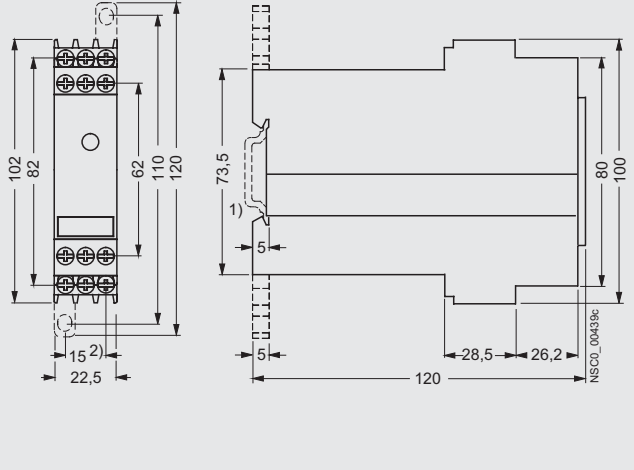

3TK28 25, 3TK28 27, 3TK28 28, 3TK28 34, 3TK28 35

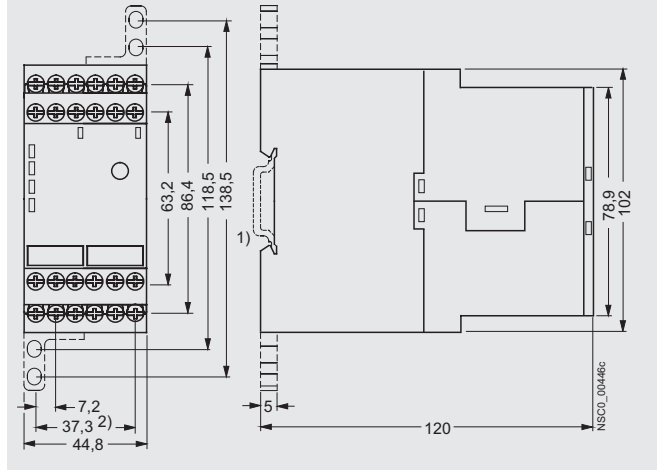

#### SIGUARD 3TK28 safety combinations (relay type) with spring-loaded terminals

3TK28 21 to 3TK28 24, 3TK28 30

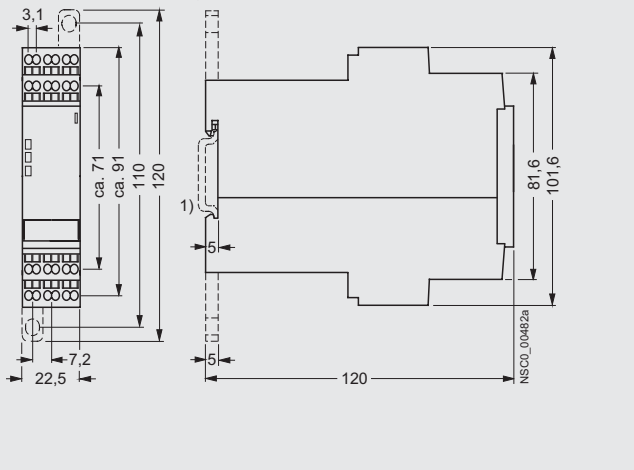

3TK28 25, 3TK28 27, 3TK28 28, 3TK28 34, 3TK28 35

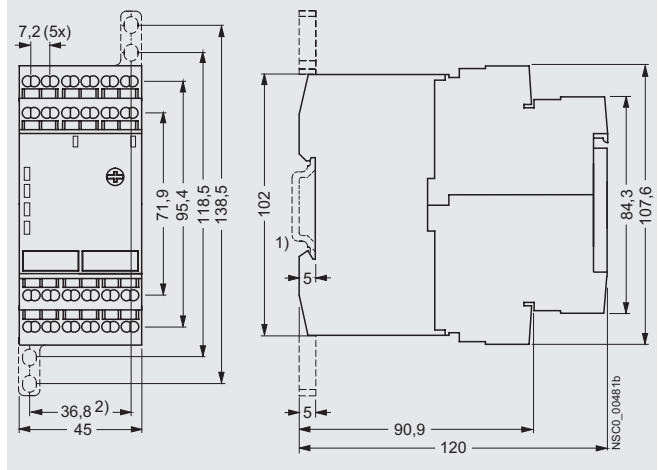

1) For 35 mm standard rail mounting EN 50022.

2) Dimension for screw-fixing. Screw-fixing with 2 push-in lugs 3RP19 03 per 3TK28 unit.

# SIGUARD Safety Combinations

## Solid-state safety combinations

### Overview

The SIGUARD safety pilot guides you quickly to the right device

Type	Conductor		Crossover protection	Category acc. to EN 954-1				EMERGENCY-STOP	Protective door	Solid-state sensors	Cascade input	Safety mats
	1-channel	2-channel		B	1	2	3					
3TK28 40 basic unit	✓	✓	✓	✓	✓	✓	✓	–	✓	–	–	–
3TK28 41 standard unit	✓	✓	✓	✓	✓	✓	✓	✓	✓	✓	1	✓
3TK28 42 standard unit tv	✓	✓	✓	✓	✓	✓	✓	✓	✓	✓	1	✓
3TK28 45 multi-function unit	✓	✓	✓	✓	✓	✓	✓	✓	✓	✓	1	✓

### With contactor relays mounted on the front

3TK28 50 basic unit	✓	✓	✓	✓	✓	✓	–	✓	✓	–	–	–
3TK28 51 basic unit	✓	✓	✓	✓	✓	✓	–	✓	✓	–	–	–
3TK28 52 basic unit	✓	✓	✓	✓	✓	✓	–	✓	✓	–	–	–
3TK28 53 basic unit	✓	✓	✓	✓	✓	✓	✓	✓	✓	✓	1	✓
3TK28 56 expansion unit	–	–	●	●	●	●	●	–	–	–	1	–
3TK28 57 expansion unit tv	–	–	●	●	●	●	●	–	–	–	1	–

Type	Enabling circuit, floating		Enabling circuit, solid-state		Signaling circuit <sup>1)</sup>	Autostart	Monitored start	Switching capacity		Rated operating voltage			Rated control supply voltage			Control inputs
	Stop category 0	Stop category 1	Stop category 0	Stop category 1				AC-15 <sup>2)</sup>	DC-13 <sup>3)</sup>	DC 24 V	AC 230 V	AC 600 V	DC 24 V	AC 115 V	AC 230 V	
3TK28 40 basic unit	–	–	2 <sup>4)</sup>		–	✓	✓	–	0.5 A	✓	–	–	✓	–	–	–
3TK28 41 standard unit	–	–	2	–	–	✓	✓	–	1.5 A	✓	–	–	✓	–	–	–
3TK28 42 standard unit tv	–	–	1	1	–	✓	✓	–	1.5 A	✓	–	–	✓	–	–	–
3TK28 45 multi-function unit	1 2	1 –	1 2	1 –	1 HL 1 HL	✓	✓	2 A	1.5 A	✓	✓	–	✓	–	–	–

### With contactor relays mounted on the front

3TK28 50 basic unit	3	–	–	–	–	✓	✓	6 A	10 A	✓	✓	✓	✓	✓	✓	–
3TK28 51 basic unit	2	–	–	–	1 NC	✓	✓	6 A	10 A	✓	✓	✓	✓	✓	✓	–
3TK28 52 basic unit	6	–	–	–	1 NC	✓	✓	6 A	10 A	✓	✓	✓	✓	✓	✓	–
3TK28 53 basic unit	3	–	1	–	–	✓	✓	6 A	10 A	✓	✓	✓	✓	–	–	1
3TK28 56 expansion unit	6	–	1	–	1 NC	–	–	6 A	10 A	✓	✓	✓	✓	–	–	1
3TK28 57 expansion unit tv	–	3	1	–	–	–	–	6 A	10 A	✓	✓	✓	✓	–	–	1

✓ = available

– = not available

● = corresponds to basic unit

1) An enabling circuit can be used as a signaling circuit.

2) At U = 230 V.

3) At U = 24 V.

4) The outputs are only safe when an external contactor is used.

# SIGUARD Safety Combinations

## Solid-state safety combinations

### Design

The European foreword of EN 60204-1, Edition 11.98 permits safe solid-state solutions for safety tasks in addition to the generally applicable switching elements with contacts. The condition is, however, that the resulting degree of safety is as high as the one achieved by the devices using contacts. The solid-state combinations comply with categories up to 4 according to EN 954-1 and SIL3 (Safety Integrity Level) according to IEC 61508.

The solid-state safety combinations can be used in EMERGENCY-STOP devices to EN 418 and in safety circuits to EN 60204-1 (11.98), for example, for moving covers and protective doors. Depending on the device type and the external circuit, the maximum category that can be achieved is Category 4 of EN 954-1 or SIL 3 according to IEC 61508.

### Solid-state safety combinations with floating, positively-driven enable contacts

With these devices, solid-state safety combinations are connected with contactor relays. The combination is supplied as a complete self-contained unit, fully wired up and tested, for snapping onto a standard rail. This unit combines the advantages of a solid-state safety combination and those of contactor relays with positively-driven contacts in a single device. It has been certified by the appropriate authorities as a complete unit.

### Basic units, Category 3

The solid-state safety combinations 3TK28 50, 51 and 52 have two contactor relays snapped onto the safety solid-state unit as floating switch blocks. Three LEDs indicate the operating status and the function. During operation, all internal circuit components are monitored cyclically for faults. Depending on the external circuit, the maximum achievable category is Category 3 according to EN 954-1.

### Basic units, Category 4

The 3TK28 53 solid-state safety combination has two contactor relays snapped onto the safety solid-states as floating switch blocks, as well as a safe solid-state output, a safe input for cascading and one input for normal switching duty. Three LEDs indicate the operating status and the function.

During start-up, the equipment runs through a self-test in which the internal solid-states is checked for correct functioning.

During operation, all internal circuit components are monitored cyclically for faults.

Expansion units and the 3TK28 30, 3TK28 56/57, 3RA711, 12, 13, 14 devices as well as external actuators or loads can be connected using the safe solid-state output (terminal 2). Cascading with the 3TK28 41/42/45/53 safety combinations as well as with the 3RA711 load feeder is also possible using the safe solid-state output (terminal 2).

### Installation

The equipment is suitable for snap-mounting on a 35 mm mounting rail to EN 50022. Screw fixing is also possible for the devices by means of 2 additional 3RP19 03 push-in lugs.

### Functions

#### The electronics (based on the example of a 3TK28 41)

- The internal circuit is configured with redundancy and diversity. The processors monitor each other dynamically.
- The output drivers are also redundant and diverse. They are monitored by a cyclic self-test.
- All sensor signals are dynamically tested. This enables faults to be detected on the sensors, wires (crossovers) etc.
- The field-effect transistor (FET) is switched by both processors. The output driver must be activated simultaneously by one of the two processors. Only then is the voltage connected safely from power supply terminal A1 to output terminals 14 + 24.
- All solid-state switches (FET + output driver) are dynamically monitored by the processors.
- The required functionality (1-channel or 2-channel), monitored start or autostart, EMERGENCY-STOP, protective door and cascading is set by means of jumpers at the connection terminals.

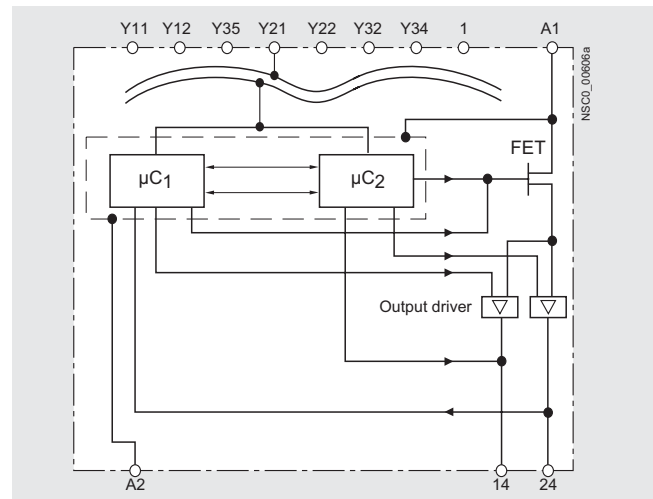

### Technical specifications

Type		3TK28 40	3TK28 41	3TK28 42	3TK28 45 <sup>1)</sup>
<b>Standards</b>		IEC 60204-1, EN 60204-1, EN 292, EN 954-1, IEC 61508, DIN VDE 0116 <sup>2)</sup>			
<b>Category acc. to EN 954-1</b>		3	4	4	4
<b>Test certificates</b>		TÜV, UL, CSA			
<b>Rated insulation voltage <math>U_i</math></b>					
• for control circuit	V	50	50	50	50
• for outputs	V	50	50	50	50 / 300
<b>Rated impulse withstand voltage <math>U_{imp}</math></b>					
• for control circuit	V	500	500	500	500
• for outputs	V	500	500	500	500 / 2000
<b>Operating range</b>					
• DC operation		0.9 ... 1.15 × $U_g$			
<b>Rated operating current <math>I_e</math></b> acc. to IEC 60947-5-1					
• $I_e$ /AC-15	at 115 V A	–	–	–	2
	at 230 V A	–	–	–	–
• $I_e$ /DC-13	at 24 V A	0.5	1.5	1.5	1.5
<b>Short-circuit protection</b>		short-circuit proof			short-circuit proof <sup>3)</sup>
<b>Electrical endurance</b>		unlimited, because switched electronically			
<b>Operating frequency z</b> in operating cycles/h during normal duty	1/h	3000			
<b>Response time</b>					
• Monitored start	ms	125	60	60	60
• Autostart	ms	250	60	60	60
<b>Release time</b>					
• for EMERGENCY-STOP	ms	30	45	45 <sup>4)</sup> / adjustable 0.05 ... 300 s	45 <sup>4)</sup> / adjustable 0.05 ... 30 s
• for supply failure	ms	25	100 <sup>5)</sup>		100 <sup>5)</sup>
<b>Recovery time</b>					
• for EMERGENCY-STOP	ms	20	400	400	400
• for supply failure	s	0.02	max. 7	max. 7	max. 7
<b>Bridging of supply failures</b>	ms	25 <sup>6)</sup>	25 <sup>5)</sup> 6)	25 <sup>5)</sup> 6)	25 <sup>6)</sup>
<b>Minimum command duration</b>					
• EMERGENCY-STOP	ms	20	25	30	30
• ON button	s	0.02	0.2 ... 5	0.2 ... 5	0.2 ... 5
<b>Simultaneity</b>	ms	∞			
<b>Conductor cross-sections</b>					
Screw terminals					
• Finely stranded with end sleeve	mm <sup>2</sup>	2 × (0.5 ... 1.5), 1 × (0.5 ... 2.5)			
• Solid	mm <sup>2</sup>	2 × (0.5 ... 2.5), 1 × (0.5 ... 4)			
• Tightening torque	Nm	0.8 ... 1.2			
Spring-loaded terminals		(1 or 2 conductors can be connected)			
• Solid	mm <sup>2</sup>	2 × (0.25 ... 1.5)			
• Finely stranded with end sleeve	mm <sup>2</sup>	2 × (0.25 ... 1.0)			
• Finely stranded without end sleeve	mm <sup>2</sup>	2 × (0.25 ... 1.5)			
• AWG conductor, solid or stranded		2 × AWG 24 ... 16			
<b>Permissible ambient temperature</b>					
• in operation	°C	–25 ... +60			
• when stored	°C	–40 ... +80			
<b>Degree of protection</b> acc. to EN 60529					
• Enclosure		IP40			
• Terminals		IP20			
<b>Touch protection</b> acc. to DIN VDE 0106 Part 100		Finger-safe			
<b>Shock resistance</b>					
• Sinewave	g/ms	8/10 and 15/5			
<b>Permissible mounting position</b>		Any			

- 1) 1 enabling contact, instantaneous, floating up to 230 V, 2.0 A.  
1 enabling contact, instantaneous, DC 24 V, 1.5 A, source input.  
1 enabling contact, delayed, floating up to 230 V, 2.0 A.  
1 enabling contact, delayed, DC 24 V, 1.5 A, source input.
- 2) Electrical equipment for furnaces.  
VDE certificate for 3TK28 41 and 3TK28 42 is available.
- 3) For relay outputs, use a fuse link:  
LV HRC Type 3NA, DIAZED Type 5SB, NEOZED Type 5SE:  
6 A (weld-free protection at  $I_k = 1$  kA)
- 4) For instantaneous output.
- 5) When the cascading input is supplied from A1, the maximum response time is applicable to an external EMERGENCY-STOP.
- 6) The drivers are not supplied, internal supply bridging only. SELV/PELV power section buffered.

# SIGUARD Safety Combinations

## Solid-state safety combinations

Type		3TK28 50	3TK28 51	3TK28 52	3TK28 53 <sup>1)</sup>	3TK28 56 <sup>1)</sup>	3TK28 57 <sup>1)</sup>
<b>Standards</b>		IEC 60204-1, EN 60204-1, EN 292, EN 954-1, IEC 61 508					
<b>Category acc. to EN 954-1</b>		3	3	3	4	2)	2)
<b>Test certificates</b>		TÜV, UL, CSA					
<b>Rated insulation voltage <math>U_i</math></b>		50					
• for control circuit	V	690					
• for output contacts	V	3					
• for pollution severity							
<b>Rated impulse withstand voltage <math>U_{imp}</math></b>		500					
• for control circuit	V	6					
• for output contacts	kV						
<b>Operating range</b>		0.85 ... 1.1 × $U_s$					
• AC operation		0.9 ... 1.15 × $U_s$					
• DC operation							
<b>Coil ratings</b>		8.5					
• DC/AC actuation at $U_s$	W						
<b>Rated operating current <math>I_e</math></b>		6					
acc. to IEC 60947-5-1		10 (auxiliary switch blocks: 6)					
• $I_e$ / AC-15	at 230 V	A					
• $I_e$ / DC-13	at 24 V	A					
<b>Short-circuit protection</b> (weld-free protection at $I_K = 1$ kA)		See 3RH1 contactor relay, technical specifications					
<b>Mechanical endurance</b>		30 million operating cycles					
<b>Electrical endurance</b>		see 3RH1 characteristic					
<b>Operating frequency <math>z</math></b> In operating cycles/h during normal duty	1/h	1000					
<b>Response time</b>							
• Monitored start	ms	200	200	200	60	–	–
• Autostart	ms	300	300	300	60	–	–
<b>Release time</b>							
• for EMERGENCY-STOP	ms	30	30	30	50	50	50 <sup>3)</sup> /adjustable 0.05 ... 300 s
• for supply failure	ms	100	100	100	120	120	120
<b>Recovery time</b>							
• for EMERGENCY-STOP	ms	20	20	20	500	500	500
• for supply failure	S	0.02	0.02	0.02	7	7	7
<b>Bridging of supply failures</b>	ms	5	5	5	5	5	5
<b>Minimum command duration</b>							
• EMERGENCY-STOP	ms	20	20	20	30		
• ON button	ms	20	20	20	0.2 ... 5 s		
<b>Simultaneity</b>		∞					
<b>Conductor cross-sections</b>							
Screw terminals							
• Finely stranded with end sleeve	mm <sup>2</sup>	2 × (0.25 ... 1), 1 × (0.25 ... 2.5)					
• Solid	mm <sup>2</sup>	2 × (0.2 ... 1), 1 × (0.2 ... 2.5)					
• Tightening torque	Nm	0.5 ... 0.6					
Spring-loaded terminals		(1 or 2 conductors can be connected)					
• Solid	mm <sup>2</sup>	1 × (0.2 ... 2.5)					
• Finely stranded with end sleeve	mm <sup>2</sup>	1 × (0.25 ... 2.5)					
• Finely stranded without end sleeve	mm <sup>2</sup>	1 × (0.25 ... 2.5)					
• AWG conductor, solid or stranded		2 × AWG 24 ... 12					
<b>Permissible ambient temperature</b>							
• in operation	°C	–25 ... +60					
• when stored	°C	–40 ... +80					
<b>Degree of protection</b> acc. to EN 60529		IP40					
• enclosure		IP20					
• terminals							
<b>Touch protection</b> acc. to DIN VDE 0106 Part 100		Finger-safe					
<b>Shock resistance</b>							
• Sinewave	g/ms	8/10 and 15/5					
<b>Permissible mounting position</b>		Any					

1) Enabling contact, instantaneous, DC 24 V, 1.5 A, source input.

2) Category as for basic unit.



3) For instantaneous output.

### Selection and ordering data



Rated control supply voltage  $U_S$  DC 24 V and AC 50/60 Hz, 115, 230 V

Enabling circuit, floating		Enabling circuit, solid-state		Signal- circuit	Achiev- able cate- gory acc. to EN 954- 1	Rated control supply voltage $U_S$ in V	DT	With screw terminals	PS*	Weight per PU approx.  kg	DT	With spring- loaded terminals	PS*	Weight per PU approx.  kg
Stop cate- gory 0	Stop cate- gory 1	Stop cate- gory 0	Stop cate- gory 1					Order No.			Order No.			

### Safety combinations, solid-state, for EMERGENCY-STOP and protective doors

	<b>Basic units</b>														
	-	-	2 <sup>1)</sup>	-	-	3	DC 24	A	<b>3TK28 40-1BB40</b>	1 unit	0.180	C	<b>3TK28 40-2BB40</b>	1 unit	0.150
	<b>Standard units</b>														
	-	-	2 <sup>3)</sup>	-	2 <sup>2)</sup>	4	DC 24	A	<b>3TK28 41-1BB40</b>	1 unit	0.166	C	<b>3TK28 41-2BB40</b>	1 unit	0.130
	<b>Standard units tv</b>														
-	-	1	1, A <sup>4)</sup>	-	4	DC 24	A	<b>3TK28 42-1BB41</b>	1 unit	0.168	C	<b>3TK28 42-2BB41</b>	1 unit	0.132	
-	-	1	1, B <sup>4)</sup>	-	4	DC 24	A	<b>3TK28 42-1BB42</b>	1 unit	0.166	C	<b>3TK28 42-2BB42</b>	1 unit	0.143	
-	-	1	1, C <sup>4)</sup>	-	4	DC 24	A	<b>3TK28 42-1BB44</b>	1 unit	0.166	A	<b>3TK28 42-2BB44</b>	1 unit	0.149	
<b>Multi-function units</b>															
1	1	1	1, A <sup>4)</sup>	1 HL <sup>2)</sup>	4	DC 24	B	<b>3TK28 45-1BB41</b>	1 unit	on requ.	C	<b>3TK28 45-2BB41</b>	1 unit	on requ.	
1	1	1	1, B <sup>4)</sup>	1 HL <sup>2)</sup>	4	DC 24	B	<b>3TK28 45-1BB42</b>	1 unit	on requ.	C	<b>3TK28 45-2BB42</b>	1 unit	on requ.	
2	-	2	-	1 HL <sup>2)</sup>	4	DC 24	B	<b>3TK28 45-1BB40</b>	1 unit	on requ.	C	<b>3TK28 45-2BB40</b>	1 unit	on requ.	

### Safety combinations, solid-state, with contactor relays, for EMERGENCY-STOP and protective doors

	<b>Basic units</b>														
	3	-	-	-	-	3	DC 24	A	<b>3TK28 50-1BB40</b>	1 unit	0.819	C	<b>3TK28 50-2BB40</b>	1 unit	0.820
	3	-	-	-	-	3	AC 115	A	<b>3TK28 50-1AJ20</b>	1 unit	0.765	C	<b>3TK28 50-2AJ20</b>	1 unit	0.650
3	-	-	-	-	3	AC 230	A	<b>3TK28 50-1AL20</b>	1 unit	0.770	B	<b>3TK28 50-2AL20</b>	1 unit	0.761	
	<b>Basic units</b>														
	2	-	-	-	1 NC	3	DC 24	A	<b>3TK28 51-1BB40</b>	1 unit	0.821	C	<b>3TK28 51-2BB40</b>	1 unit	0.650
	2	-	-	-	1 NC	3	AC 115	A	<b>3TK28 51-1AJ20</b>	1 unit	0.770	C	<b>3TK28 51-2AJ20</b>	1 unit	0.650
2	-	-	-	1 NC	3	AC 230	A	<b>3TK28 51-1AL20</b>	1 unit	0.767	C	<b>3TK28 51-2AL20</b>	1 unit	0.766	
	<b>Basic units</b>														
	6	-	-	-	1 NC	3	DC 24	A	<b>3TK28 52-1BB40</b>	1 unit	0.919	C	<b>3TK28 52-2BB40</b>	1 unit	0.935
6	-	-	-	1 NC	3	AC 230	A	<b>3TK28 52-1AL20</b>	1 unit	0.870	C	<b>3TK28 52-2AL20</b>	1 unit	0.872	
<b>Basic units</b>															
3	-	1 <sup>3)</sup>	-	-	4	DC 24	C	<b>3TK28 53-1BB40</b>	1 unit	0.650	C	<b>3TK28 53-2BB40</b>	1 unit	0.650	
<b>Expansion units<sup>5)</sup></b>															
6	-	1	-	1 NC	corre- sponds to basic unit	DC 24	B	<b>3TK28 56-1BB40</b>	1 unit	0.750	C	<b>3TK28 56-2BB40</b>	1 unit	0.750	
<b>Expansion units tv<sup>5)</sup></b>															
-	3, A	1	-	-	corre- sponds to basic unit	DC 24	B	<b>3TK28 57-1BB41</b>	1 unit	0.650	C	<b>3TK28 57-2BB41</b>	1 unit	0.650	
-	3, B	1	-	-	corre- sponds to basic unit	DC 24	B	<b>3TK28 57-1BB42</b>	1 unit	0.650	C	<b>3TK28 57-2BB42</b>	1 unit	0.650	
-	3, C	1	-	-	corre- sponds to basic unit	DC 24	B	<b>3TK28 57-1BB44</b>	1 unit	0.650	C	<b>3TK28 57-2BB44</b>	1 unit	0.650	

1) The outputs are only safe in conjunction with external actuators with positively-driven contacts.

2) An enabling circuit can be used as a signaling circuit.

3) Suitable for solid-state sensor input.

4) tv = off-delay,  
A = 0.05 ... 3 s,  
B = 0.5 ... 30 s,  
C = 5 ... 300 s

5) For expansion of the contacts for the standard and basic units  
3TK28 41, 3TK28 42, 3TK28 45, 3TK28 50, 3TK28 51, 3TK28 52,  
3TK28 53.

# SIGUARD Safety Combinations

## Solid-state safety combinations

### Dimension drawings

#### SIGUARD 3TK28 solid-state safety combinations with screw terminals

3TK28 40 to 3TK28 42

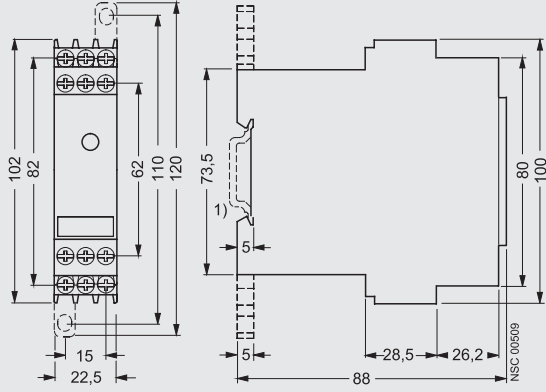

3TK28 45

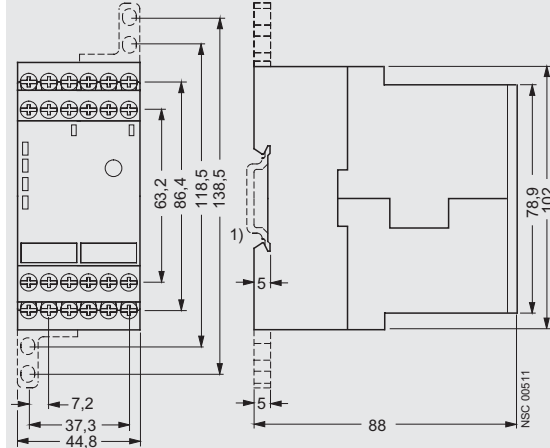

#### SIGUARD 3TK28 solid-state safety combinations with spring-loaded terminals

3TK28 40 to 3TK28 42

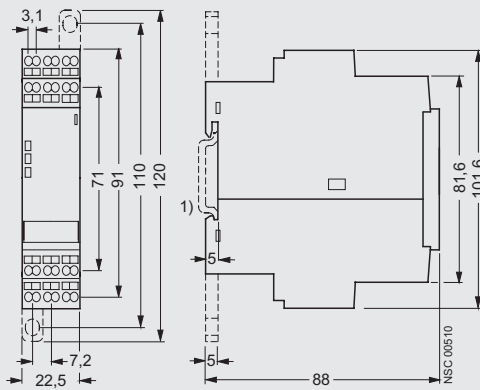

3TK28 45

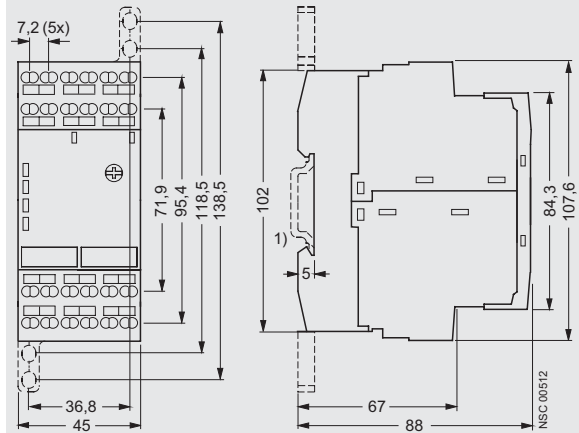

#### SIGUARD 3TK28 solid-state safety combinations with floating, positively-driven enabling contacts

3TK28 50, 3TK28 51, 3TK28 53, 3TK28 57  
with screw terminals

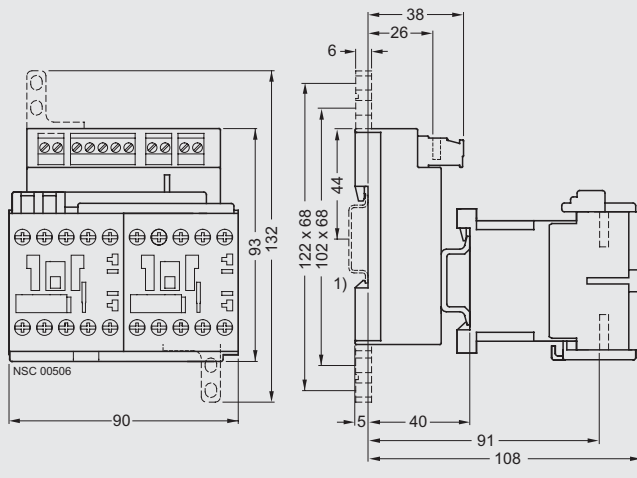

3TK28 50, 3TK28 51, 3TK28 53, 3TK28 57  
with spring-loaded terminals

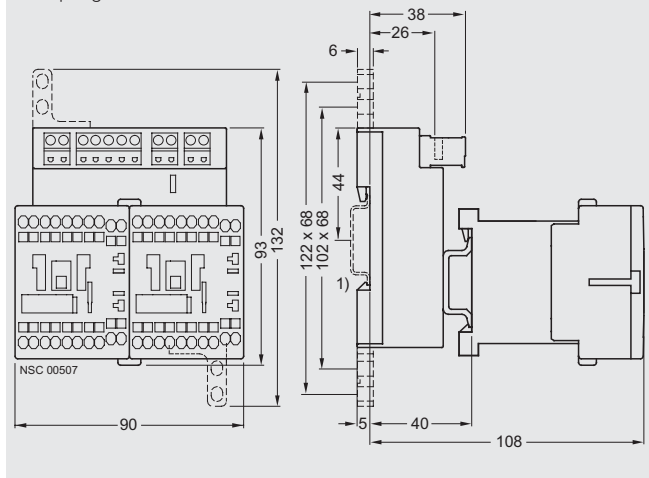

1) For 35 mm standard mounting rail acc. to EN 50022.



## Solid-state safety combinations

### SIGUARD 3TK28 solid-state safety combinations with floating, positively-driven enabling contacts

**3TK28 52, 3TK28 56**  
with screw terminals

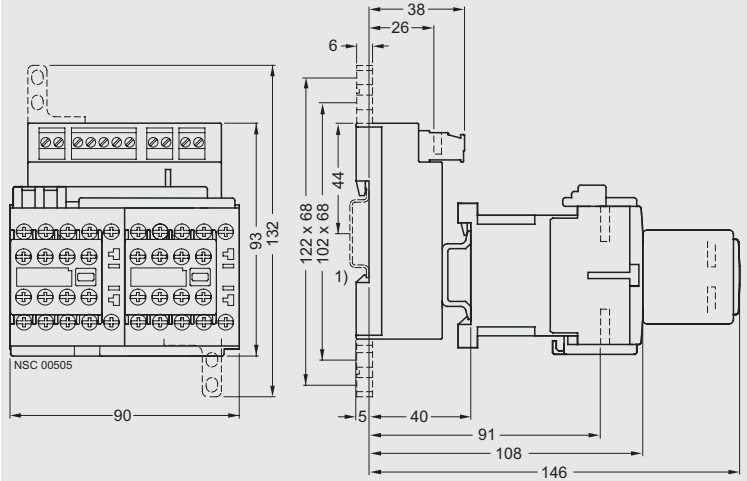

with spring-loaded terminals

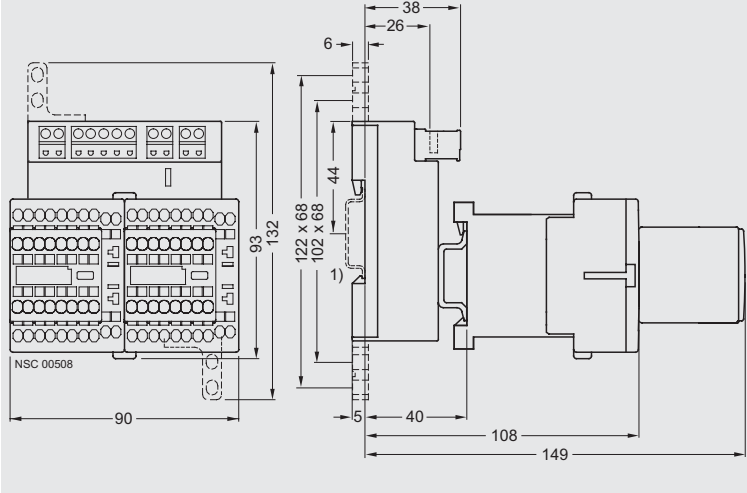

1) For 35 mm standard mounting rail acc. to EN 50022.

# Load Feeders with Integrated Safety Functions

## General data

### Area of application

The 3RA71 safety load feeders are offered for direct-on-line starting. They are available with operating voltages of 230 V 50/60 Hz (Category 3) and DC 24 V (Categories 3 and 4). Depending on the external circuit, choice of actuator and its position on the machine, Categories 3 or 4 according to EN 954-1 or SIL 2 or 3 (Safety Integrity Level) according to IEC 61508 can be achieved.

Similarly the product range of safety load feeders contains expansion units with and without time delays. These expansion units can only be used in combination with a basic unit. Load feeders can be configured in Stop category 1 thanks to expansion units with time delays from 0.05 to 3 s, or 0.5 to 30 s.

### Classification types

EN 60947-4-1 and IEC 60947-4-1 make a distinction between two different types of coordination, which are designated type of coordination "1" and type of coordination "2". Any short-circuits that occur are cleared safely by both types of coordination. The only differences concern the extent of the damage caused to the equipment by a short-circuit.

#### ■ Type of coordination 2:

There must be no damage to the overload release or to any other components after a short-circuit has been cleared. The 3RA71 safety load feeder can resume operation without components needing to be renewed. At most, it is permissible to weld the contactor contacts if they can be disconnected easily without any significant deformation. Classification of a machine in categories acc. to EN 954-1

## Design

The 3RA71 safety load feeders comprise an adapter for rail mounting with integrated safety electronics (as used for the 3TK28 solid-state safety combinations), a circuit-breaker, and two redundant contactors connected in series. The combination of safety electronics, circuit-breakers and contactors result in a pre-assembled and pre-wired fuseless load feeder with type of coordination 1 or 2, that is tested and certified as a complete safety load feeder.

The 3RA71.0 safety load feeder is an exception; it does not have a circuit-breaker. To build up a complete load feeder, it must be connected in series with a fuse or circuit-breaker.

The load feeder has a safe solid-state output, a safe input for cascading and an input for normal switching duty. Three LEDs on the front indicate the operating state.

Expansion units as well as actuators or load feeders can be connected to safe output 2. Safe output 2 can also be used for cascading with 3TK28 41, 3TK28 42, 3TK28 45, 3TK28 53 and 3RA71 1 safety combinations. The load feeder and the actuator or load must have the same ground potential.

### Power supply for DC actuation

In the version with a DC 24 V control supply voltage, a power supply to DIN VDE 0106 (PELV) of safety class III must be used to supply the electronics.

## Accessories

Since the safety load feeder is made up of the 3RV1 circuit-breaker and the 3RT1 contactors, accessories, e.g. auxiliary switches, from the SIRIUS modular system can be used.

## Installation

The 3RA71 safety load feeders can be snapped onto a standard mounting rail to EN 50022 – 35 × 15.

## Functions

### Fault monitoring

During start-up, the equipment runs through a self-test in which the internal electronics is checked for correct functioning. During operation, all internal circuit components are monitored cyclically for faults.

### Cascading, expanding

The devices for Category 4 support easy connection (cascading) and expansion of several safety devices to form hard-wired safety logic. The devices for Category 4 have one solid-state safe output (terminal 2) and one cascading input (terminal 1).

On terminal 1, the devices expect a safe 24 V signal which is safely evaluated. If this signal is missing, the device switches off safely. The switch-on conditions are the same as the conditions for sensor switch-off (EMERGENCY-STOP actuation).

### Normal switching duty

In the devices for Category 4, terminals 3 and 4 can be used for normal switching duty (On/Off) of the contactors. There are two possibilities for normal switching duty, either using a floating contact (terminals 3 and 4) or a contact connected to a potential (DC 24 V), e.g. through a PLC (terminal 4 only). Normal switching duty is subordinate to the safety function.

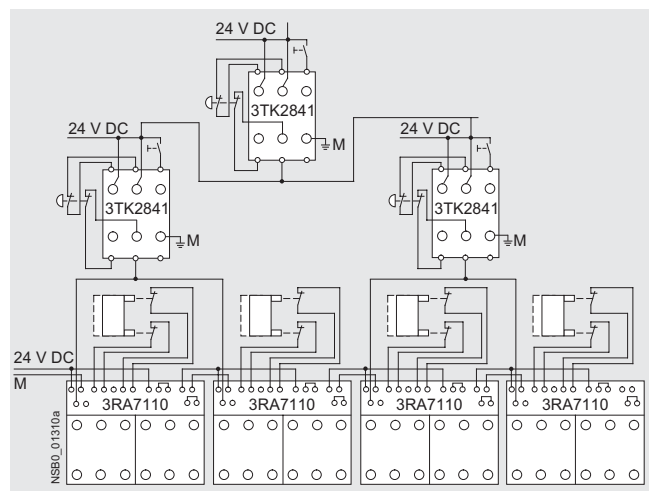

Typical circuit diagram for cascading with 3TK28 41 and 3RA71 safety electronics (Category 4 with expansion units)

# Load Feeders with Integrated Safety Functions

## General data

### Technical specifications

General technical specifications for the power unit, i.e. the circuit-breakers and contactors, can be found in the technical specifications of the 3RA1 series of fuseless load feeders in Section 6.

Detailed technical specifications for the individual devices can be found in the technical specifications of 3RT1 contactors in Section 2 and 3RV1 circuit-breakers in Section 4.

Type	AC basic unit Category 3	DC basic unit Category 3	DC basic unit Category 4	Expansion unit	Expansion unit, time-delayed
<b>Standards</b>	IEC 60204-1, EN 60204-1, EN 292, EN 954-1, IEC 61508				
<b>Test certificate</b>	TÜV, UL, CSA				
<b>Category acc. to EN 954-1</b>	3	3	4	4 <sup>1)</sup>	4 <sup>1)</sup>
<b>Safety Integrity Level (SIL) acc. to IEC 61508</b>	2	2	3	3 <sup>1)</sup>	3 <sup>1)</sup>
<b>Rated insulation voltage <math>U_i</math></b>	690 V				
<b>Rated impulse withstand voltage <math>U_{imp}</math></b>	6 kV				
<b>Coil ratings</b>	2 W <sup>2)</sup>				
• DC/AC actuation at $1.0 \times U_s$	2 W <sup>2)</sup>				
<b>Operating range</b>					
• AC operation	0.85 ... $1.1 \times U_s$				
• DC operation	0.9 ... $1.1 \times U_s$				
<b>Response time</b>					
• monitored start	125 ms typ. <sup>3)</sup>		400 ms typ. <sup>3)</sup>		
• Autostart	250 ms typ. <sup>3)</sup>		400 ms typ. <sup>3)</sup>		
<b>Release time</b>					
• for EMERGENCY-STOP	20 ms typ. <sup>4)</sup>		25 ms typ.		after time has elapsed
• for supply failure	100 ms		100 ms		100 ms
<b>Recovery time</b>					
• for EMERGENCY-STOP	20 ms typ.		400 ms typ.		
• for supply failure	20 ms typ.		7 NO		
<b>Bridging of supply failures</b>	5 ms (see technical specifications for contactors used)				
<b>Minimum command duration</b>					
• EMERGENCY-STOP	> 20 ms typ.		> 25 ms typ.		
• ON button	> 20 ms typ.		> 100 ms typ.		
<b>Conductor cross-sections</b>					
• Solid	1 × 0.2 ... 2.5 mm <sup>2</sup>				
• Finely stranded with end sleeve	1 × 0.25 ... 2.5 mm <sup>2</sup>				
• Starting torque, M 3 connecting screw	0.5 ... 0.6 Nm				
<b>Permissible ambient temperature</b>					
• in operation	-20 ... +60 °C				
• when stored	-40 ... +80 °C				
<b>Degree of protection</b>	IP20				
<b>Touch protection</b>	Finger-safe				

- 1) The maximum achievable category is the category of the basic unit. The category also depends on the external circuit, the command device selected and their physical location on the machine. Compliance with the standards and regulations for safety at the machine is essential.
- 2) Note the power losses of the respective power unit (see technical specifications of the circuit-breaker and contactor).
- 3) Note the pick-up time for the respective contactor (see technical specifications of the contactors).
- 4) Note the drop-out time for the respective contactor (see technical specifications of the contactors).

# Load Feeders with Integrated Safety Functions

## General data

### Circuit diagrams

#### Connection examples

##### 3RA71 01 and 3RA71 02 fuseless load feeders

Basic unit, Category 3 <sup>1)</sup>

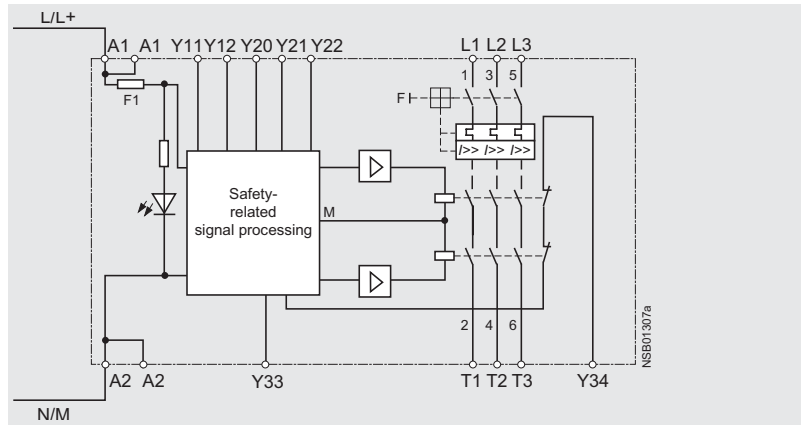
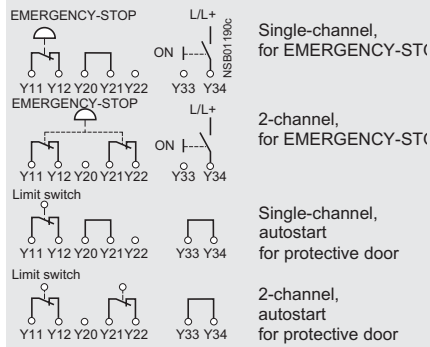

##### 3RA71 10 fused load feeders

Basic unit, Category 4 <sup>2)</sup>

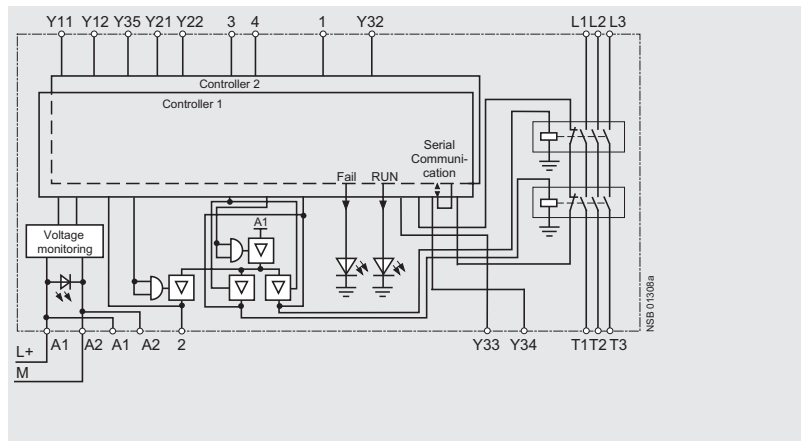
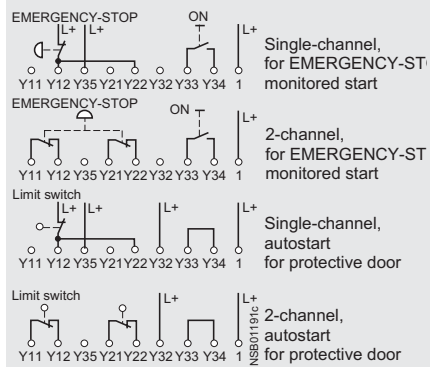

##### 3RA71 20, 3RA71 30 and 3RA71 40 fused load feeders

Expansion unit <sup>2)</sup>

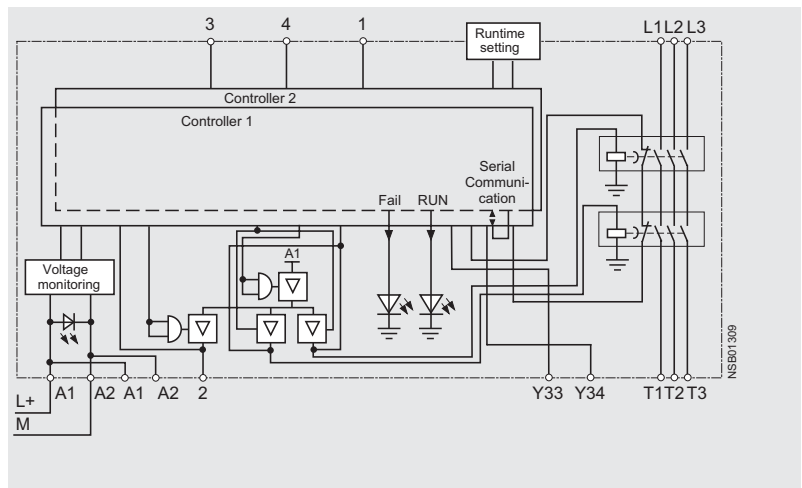
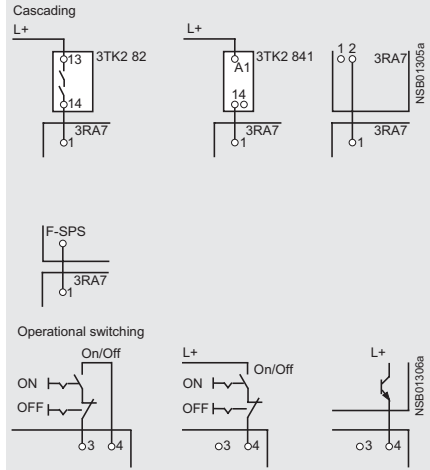

- 1) Also available as contactor safety combination without circuit-breaker.
- 2) Also available as fuseless load feeder with circuit-breaker.

# Load Feeders with Integrated Safety Functions

## Fuseless load feeders

### Selection and ordering data

#### Rated control supply voltage AC 50/60 Hz 230 V for mounting on 35 mm standard mounting rail

- Circuit-breakers, contactors and safety electronics are pre-wired and certified up to Category 3 acc. to EN 954-1
- Auxiliary switches on the circuit-breaker and the contactor can be easily fitted thanks to the SIRIUS modular system



3RA71 02

#### Direct-on-line starting

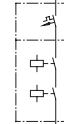

Size	Three-phase standard motor <sup>1)</sup> 4-pole, at AC 400 V	Setting range thermal overload release	DT	Basic unit, Category 3 <sup>2)</sup>	PS*	Weight per PU approx.
	Rated power <i>P</i> kW	Motor current <i>I</i> A		Order No.		kg
<b>Type of coordination 2 at <math>I_{cl} = 50</math> kA at 400 V (compatible with type of coordination 1)</b>						
S00	0.04	0.16	0.11 ... 0.16	B 3RA71 01-0AA17-0AL2	1 unit	0.820
	0.06	0.2	0.14 ... 0.2	B 3RA71 01-0BA17-0AL2	1 unit	1.440
	0.06	0.2	0.18 ... 0.25	B 3RA71 01-0CA17-0AL2	1 unit	0.820
	0.09	0.3	0.22 ... 0.32	B 3RA71 01-0DA17-0AL2	1 unit	1.430
	0.09	0.3	0.28 ... 0.4	B 3RA71 01-0EA17-0AL2	1 unit	0.820
	0.12	0.4	0.35 ... 0.5	B 3RA71 01-0FA17-0AL2	1 unit	0.820
	0.18	0.6	0.45 ... 0.63	B 3RA71 01-0GA17-0AL2	1 unit	0.820
	0.25	0.8	0.55 ... 0.8	B 3RA71 01-0HA17-0AL2	1 unit	0.820
	0.25	0.8	0.7 ... 1	B 3RA71 01-0JA17-0AL2	1 unit	0.820
	0.37	1.1	0.9 ... 1.25	B 3RA71 01-0KA17-0AL2	1 unit	1.480
	0.55	1.5	1.1 ... 1.6	B 3RA71 01-1AA17-0AL2	1 unit	0.820
	0.75	1.9	1.4 ... 2	B 3RA71 01-1BA17-0AL2	1 unit	1.470
	S0	0.75	1.9	1.8 ... 2.5	B 3RA71 02-1CA26-0AL2	1 unit
1.1		2.7	2.2 ... 3.2	B 3RA71 02-1DA26-0AL2	1 unit	1.860
1.5		3.6	2.8 ... 4	B 3RA71 02-1EA26-0AL2	1 unit	1.200
1.5		3.6	3.5 ... 5	B 3RA71 02-1FA26-0AL2	1 unit	1.200
2.2		5.2	4.5 ... 6.3	B 3RA71 02-1GA26-0AL2	1 unit	1.910
3		6.8	5.5 ... 8	B 3RA71 02-1HA26-0AL2	1 unit	1.940
4		9.0	7 ... 10	B 3RA71 02-1JA26-0AL2	1 unit	1.200
5.5		11.5	9 ... 12.5	B 3RA71 02-1KA26-0AL2	1 unit	1.200
7.5		15.5	11 ... 16	B 3RA71 02-4AA26-0AL2	1 unit	1.200
7.5		15.5	14 ... 20	B 3RA71 02-4BA26-0AL2	1 unit	1.200
7.5		15.5	17 ... 22	B 3RA71 02-4CA26-0AL2	1 unit	1.920

1) Selection depends on the correct startup and rated data of the protected motor.

2) The maximum achievable category acc. to EN 954-1 is the category of the basic unit. The category also depends on the external circuit, the command device selected and their location on the machine. Compliance with the standards and regulations for safety at the machine is essential.

# Load Feeders with Integrated Safety Functions

## Fuseless load feeders

**Rated control supply voltage DC 24 V  
for mounting on 35 mm standard mounting rail**

- Circuit-breakers, contactors and safety electronics pre-wired and certified up to Category 4 acc. to EN 954-1
- Auxiliary switches on the circuit-breaker and the contactor can be easily fitted thanks to the SIRIUS modular system
- Expansion units for multiple load feeders in one safety circuit



3RA71 02

**Direct-on-line starting**

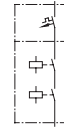

Size	Three-phase standard motor <sup>1)</sup> 4-pole, at AC 400 V Rated power <i>P</i> Motor current <i>I</i>		Setting range Thermal overload release 	DT	Basic unit, Category 3 <sup>2)</sup>	PS*	Weight per PU approx.	DT	Basic unit, Category 4 <sup>2)</sup>	PS*	Weight per PU approx.
	kW	A	A		Order No.		kg		Order No.		kg
<b>Type of coordination 2 at <math>I_q = 50</math> kA at 400 V</b>											
S00	0.06	0.2	0.11 ... 0.16	C	3RA71 01-0AA17-0AB4	1 unit	1.500	B	3RA71 11-0AA17-0AB4	1 unit	1.370
	0.06	0.2	0.14 ... 0.2	C	3RA71 01-0BA17-0AB4	1 unit	0.820	B	3RA71 11-0BA17-0AB4	1 unit	0.820
	0.06	0.2	0.18 ... 0.25	C	3RA71 01-0CA17-0AB4	1 unit	0.820	B	3RA71 11-0CA17-0AB4	1 unit	0.820
	0.09	0.3	0.22 ... 0.32	C	3RA71 01-0DA17-0AB4	1 unit	0.820	B	3RA71 11-0DA17-0AB4	1 unit	0.820
	0.09	0.3	0.28 ... 0.4	C	3RA71 01-0EA17-0AB4	1 unit	0.820	B	3RA71 11-0EA17-0AB4	1 unit	0.820
	0.12	0.4	0.35 ... 0.5	C	3RA71 01-0FA17-0AB4	1 unit	0.820	B	3RA71 11-0FA17-0AB4	1 unit	0.820
	0.18	0.6	0.45 ... 0.63	C	3RA71 01-0GA17-0AB4	1 unit	0.820	B	3RA71 11-0GA17-0AB4	1 unit	0.820
	0.25	0.8	0.55 ... 0.8	C	3RA71 01-0HA17-0AB4	1 unit	0.820	B	3RA71 11-0HA17-0AB4	1 unit	0.820
	0.25	0.8	0.7 ... 1	C	3RA71 01-0JA17-0AB4	1 unit	0.820	B	3RA71 11-0JA17-0AB4	1 unit	0.820
	0.37	1.1	0.9 ... 1.25	C	3RA71 01-0KA17-0AB4	1 unit	0.820	B	3RA71 11-0KA17-0AB4	1 unit	0.820
	0.55	1.5	1.1 ... 1.6	C	3RA71 01-1AA17-0AB4	1 unit	1.550	B	3RA71 11-1AA17-0AB4	1 unit	0.820
	0.75	1.9	1.4 ... 2	B	3RA71 01-1BA17-0AB4	1 unit	2.260	B	3RA71 11-1BA17-0AB4	1 unit	0.820
S0	0.75	2.7	1.8 ... 2.5	B	3RA71 02-1CA26-0AB4	1 unit	2.250	B	3RA71 12-1CA26-0AB4	1 unit	1.200
	1.1	2.7	2.2 ... 3.2	B	3RA71 02-1DA26-0AB4	1 unit	2.250	B	3RA71 12-1DA26-0AB4	1 unit	1.860
	1.5	3.6	2.8 ... 4	C	3RA71 02-1EA26-0AB4	1 unit	1.200	B	3RA71 12-1EA26-0AB4	1 unit	1.200
	1.5	3.6	3.5 ... 5	C	3RA71 02-1FA26-0AB4	1 unit	1.200	B	3RA71 12-1FA26-0AB4	1 unit	1.200
	2.2	5.2	4.5 ... 6.3	C	3RA71 02-1GA26-0AB4	1 unit	2.290	B	3RA71 12-1GA26-0AB4	1 unit	1.800
	3	6.8	5.5 ... 8	C	3RA71 02-1HA26-0AB4	1 unit	1.200	B	3RA71 12-1HA26-0AB4	1 unit	1.810
	4	9.0	7 ... 10	C	3RA71 02-1JA26-0AB4	1 unit	1.200	B	3RA71 12-1JA26-0AB4	1 unit	1.830
	5.5	11.5	9 ... 12.5	C	3RA71 02-1KA26-0AB4	1 unit	1.200	B	3RA71 12-1KA26-0AB4	1 unit	1.850
	7.5	15.5	11 ... 16	C	3RA71 02-4AA26-0AB4	1 unit	1.200	B	3RA71 12-4AA26-0AB4	1 unit	1.200
	7.5	15.5	14 ... 20	C	3RA71 02-4BA26-0AB4	1 unit	1.200	B	3RA71 12-4BA26-0AB4	1 unit	1.200
	7.5	15.5	17 ... 22	C	3RA71 02-4CA26-0AB4	1 unit	1.200	B	3RA71 12-4CA26-0AB4	1 unit	1.200

Size	Three-phase standard motor <sup>1)</sup> 4-pole, at AC 400 V Rated power <i>P</i> Motor current <i>I</i>		Setting range Thermal overload release 	DT	Expansion unit <sup>2)</sup>	PS*	Weight per PU approx.
	kW	A	A		Order No.		kg
<b>Type of coordination 2 at <math>I_q = 50</math> kA at 400 V</b>							
S00	0.06	0.2	0.11 ... 0.16	B	3RA71 21-0AA17-0AB4	1 unit	0.820
	0.06	0.2	0.14 ... 0.2	B	3RA71 21-0BA17-0AB4	1 unit	0.820
	0.06	0.2	0.18 ... 0.25	B	3RA71 21-0CA17-0AB4	1 unit	0.820
	0.09	0.3	0.22 ... 0.32	B	3RA71 21-0DA17-0AB4	1 unit	0.820
	0.09	0.3	0.28 ... 0.4	B	3RA71 21-0EA17-0AB4	1 unit	0.820
	0.12	0.4	0.35 ... 0.5	B	3RA71 21-0FA17-0AB4	1 unit	0.820
	0.18	0.6	0.45 ... 0.63	B	3RA71 21-0GA17-0AB4	1 unit	0.820
	0.25	0.8	0.55 ... 0.8	B	3RA71 21-0HA17-0AB4	1 unit	0.820
	0.25	0.8	0.7 ... 1	B	3RA71 21-0JA17-0AB4	1 unit	0.820
	0.37	1.1	0.9 ... 1.25	B	3RA71 21-0KA17-0AB4	1 unit	0.820
	0.55	1.5	1.1 ... 1.6	B	3RA71 21-1AA17-0AB4	1 unit	0.820
	0.75	1.9	1.4 ... 2	B	3RA71 21-1BA17-0AB4	1 unit	0.820
S0	0.75	2.7	1.8 ... 2.5	B	3RA71 22-1CA26-0AB4	1 unit	1.200
	1.1	2.7	2.2 ... 3.2	B	3RA71 22-1DA26-0AB4	1 unit	1.200
	1.5	3.6	2.8 ... 4	B	3RA71 22-1EA26-0AB4	1 unit	1.200
	1.5	3.6	3.5 ... 5	B	3RA71 22-1FA26-0AB4	1 unit	1.200
	2.2	5.2	4.5 ... 6.3	B	3RA71 22-1GA26-0AB4	1 unit	1.200
	3	6.8	5.5 ... 8	B	3RA71 22-1HA26-0AB4	1 unit	1.200
	4	9.0	7 ... 10	B	3RA71 22-1JA26-0AB4	1 unit	1.200
	5.5	11.5	9 ... 12.5	B	3RA71 22-1KA26-0AB4	1 unit	1.200
	7.5	15.5	11 ... 16	B	3RA71 22-4AA26-0AB4	1 unit	1.200
	7.5	15.5	14 ... 20	B	3RA71 22-4BA26-0AB4	1 unit	1.200
	7.5	15.5	17 ... 22	B	3RA71 22-4CA26-0AB4	1 unit	1.200

# Load Feeders with Integrated Safety Functions

## Fuseless load feeders

Size	Three-phase standard motor 1)		Setting range Thermal overload release 	DT	Expansion unit, time-delayed 0.05 ... 3 s <sup>2)</sup>	PS*	Weight per PU approx.	DT	Expansion unit, time-delayed 0.5 ... 30 s <sup>2) 3)</sup>	PS*	Weight per PU approx.
	kW	A									
<b>Type of coordination 2 at <math>I_G = 50</math> kA at 400 V</b>											
S00	0.06	0.2	0.11 ... 0.16	B	<b>3RA71 31-0AA17-0AB4</b>	1 unit	0.820	B	<b>3RA71 41-0AA17-0AB4</b>	1 unit	0.820
	0.06	0.2	0.14 ... 0.2	B	<b>3RA71 31-0BA17-0AB4</b>	1 unit	0.820	B	<b>3RA71 41-0BA17-0AB4</b>	1 unit	0.820
	0.06	0.2	0.18 ... 0.25	B	<b>3RA71 31-0CA17-0AB4</b>	1 unit	0.820	B	<b>3RA71 41-0CA17-0AB4</b>	1 unit	0.820
	0.09	0.3	0.22 ... 0.32	B	<b>3RA71 31-0DA17-0AB4</b>	1 unit	0.820	B	<b>3RA71 41-0DA17-0AB4</b>	1 unit	0.820
	0.09	0.3	0.28 ... 0.4	B	<b>3RA71 31-0EA17-0AB4</b>	1 unit	0.820	B	<b>3RA71 41-0EA17-0AB4</b>	1 unit	0.820
	0.12	0.4	0.35 ... 0.5	B	<b>3RA71 31-0FA17-0AB4</b>	1 unit	0.820	B	<b>3RA71 41-0FA17-0AB4</b>	1 unit	0.820
	0.18	0.6	0.45 ... 0.63	B	<b>3RA71 31-0GA17-0AB4</b>	1 unit	0.820	B	<b>3RA71 41-0GA17-0AB4</b>	1 unit	0.820
	0.25	0.8	0.55 ... 0.8	B	<b>3RA71 31-0HA17-0AB4</b>	1 unit	0.820	B	<b>3RA71 41-0HA17-0AB4</b>	1 unit	0.820
	0.25	0.8	0.7 ... 1	B	<b>3RA71 31-0JA17-0AB4</b>	1 unit	0.820	B	<b>3RA71 41-0JA17-0AB4</b>	1 unit	0.820
	0.37	1.1	0.9 ... 1.25	B	<b>3RA71 31-0KA17-0AB4</b>	1 unit	0.820	B	<b>3RA71 41-0KA17-0AB4</b>	1 unit	0.820
	0.55	1.5	1.1 ... 1.6	B	<b>3RA71 31-1AA17-0AB4</b>	1 unit	0.820	B	<b>3RA71 41-1AA17-0AB4</b>	1 unit	0.820
0.75	1.9	1.4 ... 2	B	<b>3RA71 31-1BA17-0AB4</b>	1 unit	0.820	B	<b>3RA71 41-1BA17-0AB4</b>	1 unit	0.820	
S0	0.75	2.7	1.8 ... 2.5	B	<b>3RA71 32-1CA26-0AB4</b>	1 unit	1.200	B	<b>3RA71 42-1CA26-0AB4</b>	1 unit	1.200
	1.1	2.7	2.2 ... 3.2	B	<b>3RA71 32-1DA26-0AB4</b>	1 unit	1.200	B	<b>3RA71 42-1DA26-0AB4</b>	1 unit	1.200
	1.5	3.6	2.8 ... 4	B	<b>3RA71 32-1EA26-0AB4</b>	1 unit	1.200	B	<b>3RA71 42-1EA26-0AB4</b>	1 unit	1.200
	1.5	3.6	3.5 ... 5	B	<b>3RA71 32-1FA26-0AB4</b>	1 unit	1.200	B	<b>3RA71 42-1FA26-0AB4</b>	1 unit	1.200
	2.2	5.2	4.5 ... 6.3	B	<b>3RA71 32-1GA26-0AB4</b>	1 unit	1.200	B	<b>3RA71 42-1GA26-0AB4</b>	1 unit	1.200
	3	6.8	5.5 ... 8	B	<b>3RA71 32-1HA26-0AB4</b>	1 unit	1.200	B	<b>3RA71 42-1HA26-0AB4</b>	1 unit	1.200
	4	9.0	7 ... 10	B	<b>3RA71 32-1JA26-0AB4</b>	1 unit	1.200	B	<b>3RA71 42-1JA26-0AB4</b>	1 unit	1.200
	5.5	11.5	9 ... 12.5	B	<b>3RA71 32-1KA26-0AB4</b>	1 unit	1.200	B	<b>3RA71 42-1KA26-0AB4</b>	1 unit	1.200
	7.5	15.5	11 ... 16	B	<b>3RA71 32-4AA26-0AB4</b>	1 unit	1.200	B	<b>3RA71 42-4AA26-0AB4</b>	1 unit	1.200
	7.5	15.5	14 ... 20	B	<b>3RA71 32-4BA26-0AB4</b>	1 unit	1.200	B	<b>3RA71 42-4BA26-0AB4</b>	1 unit	1.200
	7.5	15.5	17 ... 22	B	<b>3RA71 32-4CA26-0AB4</b>	1 unit	1.200	B	<b>3RA71 42-4CA26-0AB4</b>	1 unit	1.200

- Selection depends on the correct startup and rated data of the protected motor.
- The maximum achievable category acc. to EN 954-1 is the category of the basic unit. The category also depends on the external circuit,

the command device selected and their location on the machine. Compliance with the standards and regulations for safety at the machine is essential.

- Delay times between 5 and 300 s available on request.

### Dimension drawings

3RA71 .1, size S00

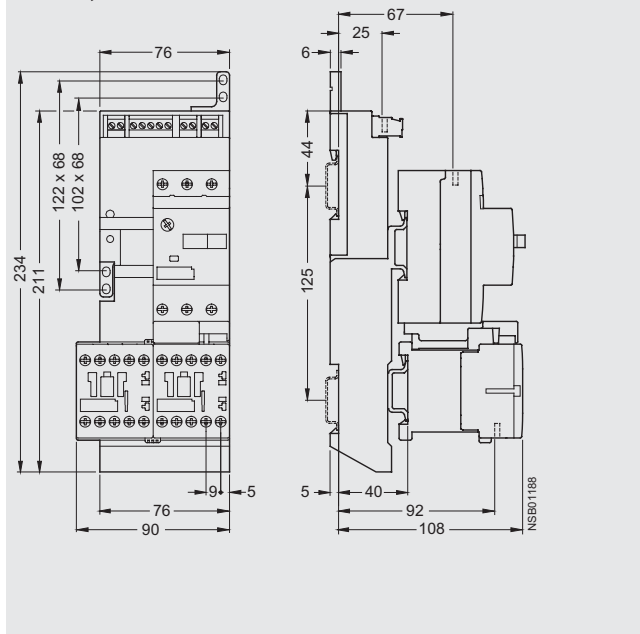

3RA71 .2, size S0

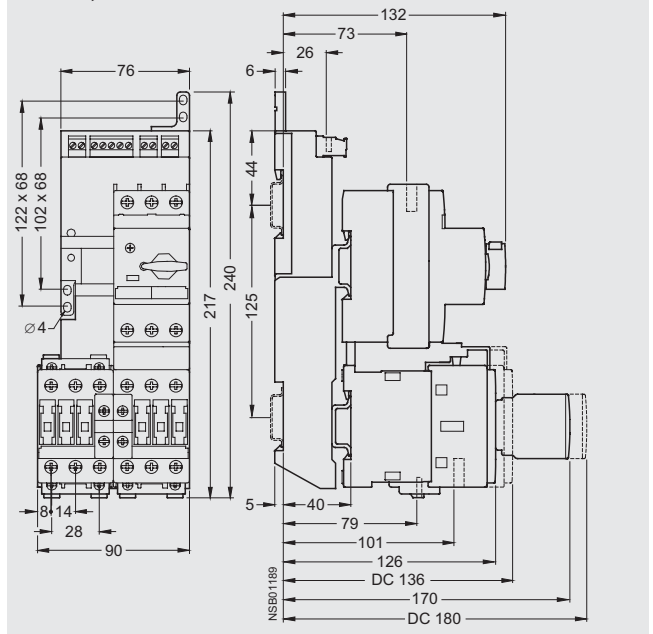

# Load Feeders with Integrated Safety Functions

## Fused load feeders

### Selection and ordering data

#### Rated control supply voltage AC 50/60 Hz 230 V for mounting on 35 mm standard mounting rail

- For the separate mounting of contactors with fuses
- Contactors and safety electronics pre-assembled, pre-wired and certified up to Category 3 acc. to EN 954-1
- Auxiliary switches on the contactor can be easily fitted thanks to the SIRIUS modular system



Direct-on-line starting



3RA71 00

Size	Category according to EN 954-1 <sup>2)</sup>	Three-phase standard motor <sup>1)</sup> 4-pole, at AC 400 V		DT	Order No.	PS*	Weight per PU approx.
		Rated power <i>P</i> kW	Motor current <i>I</i> A				kg
S0	3	11	22.5	C	<b>3RA71 00-5AA26-0AL2</b>	1 unit	0.620

#### Rated control supply voltage DC 24 V for mounting on 35 mm standard mounting rail

- For the separate mounting of contactors with fuses
- Contactors and safety electronics pre-assembled, pre-wired and certified up to Category 4 acc. to EN 954-1
- Auxiliary switches on the contactor can be easily fitted due to the SIRIUS modular system
- Expansion units for multiple load feeders in one safety circuit



Direct-on-line starting



3RA71 00

Size	Category according to EN 954-1 <sup>2)</sup>	Three-phase standard motor <sup>1)</sup> 4-pole, at AC 400 V		Type	DT	Order No.	PS*	Weight per PU approx.
		Rated power <i>P</i> kW	Motor current <i>I</i> A					kg
S0	3	11	22.5	Basic unit	C	<b>3RA71 00-5AA26-0AB4</b>	1 unit	1.510
	4	11	22.5	Basic unit	B	<b>3RA71 10-5AA26-0AB4</b>	1 unit	1.090
	as basic unit	–	–	Expansion unit	B	<b>3RA71 20-5AA26-0AB4</b>	1 unit	0.620
	as basic unit	–	–	Expansion unit, time-delayed 0.05 ... 3 s	B	<b>3RA71 30-5AA26-0AB4</b>	1 unit	0.620
	as basic unit	–	–	Expansion unit, time-delayed 0.5 ... 30 s <sup>3)</sup>	B	<b>3RA71 40-5AA26-0AB4</b>	1 unit	0.620

- 1) Selection depends on the correct startup and rated data of the protected motor.
- 2) The maximum achievable category acc. to EN 954-1 is the category of the basic unit. The category also depends on the external circuit, the command device selected and their location on the machine. Compliance with the standards and regulations for safety at the machine is essential.
- 3) Delay times between 5 and 300 s available on request.

### Dimension drawings

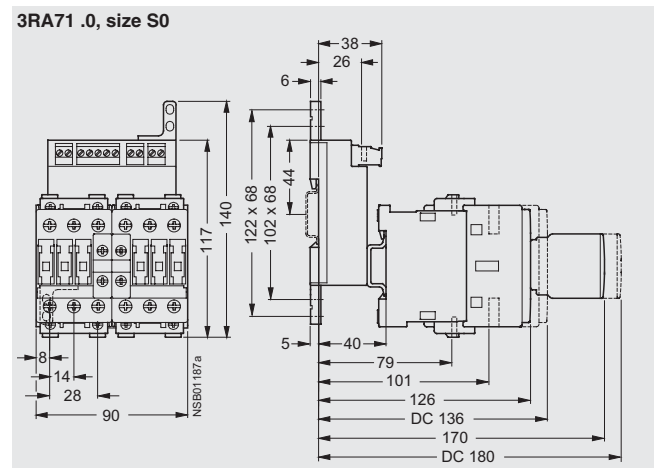



### Overview



SIGUARD 3RG78 4 light curtains and light arrays

- are active opto-solid-state protective devices (AOPD),
- Type 2 or Type 4 acc. to EN 61496-1, -2,
- EU type-tested,
- protect the operating personnel on or near dangerous machines,
- non-contact operating,
- weld-free in comparison to mechanical systems (e.g. safety mats).

For further details, see the manual "Safety Integrated" and the operating instructions for the applicable devices.

#### Tests/service

The devices are EU type-tested (TÜV Product Service in cooperation with the BIA).

If required, tests can be performed before initial start-up, as well as the annual inspection (such as that required by law for presses). Please ask your Siemens contact person.

### Benefits

Integrated functions:

- Start-up/restart inhibit
- Contactor control
- Fixed blanking
- Floating blanking
- Reduced resolution
- Muting
- Multi-scan function
- Cycle control (as option)

Configuration:

- Via teach-in key and opto-magnetic key
- Transmission of the configuration data via a plug-in configuration card
- 2 transmission channels
- Cascading of host and guest devices
- Expanded display (2 × 7 segments)

Outputs/connections:

- Local interface
- Hirschmann connection (as an option)
- Transistor outputs
- Relay outputs
- Connection to AS-Interface (see Catalog IK PI)

### Area of application

#### Light curtains for finger and hand protection in danger zones

Protection against touching danger zones where light curtains are mounted close to dangerous machine parts (finger and hand protection)



#### Device selection

Light curtains for Category 2 or 4 with 14 and 30 mm resolution

#### Applications

e.g. hydraulic and mechanical presses, punches, filter presses, cutting machines

#### Light curtains for horizontal danger zone security at floor level

Reliable recognition of persons in danger zones when the light curtain is mounted close to the floor (crawling underneath is not possible)

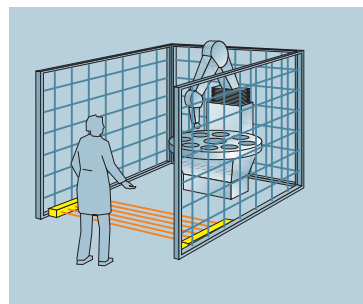

#### Device selection

Light curtains for Category 2 or 4 with 50 or 55 mm resolution

#### Applications

e.g. welding and assembly lines as well as welding and assembly robots in the automotive industry.

# SIGUARD Light Curtains and Arrays

## General data

### Light curtains for horizontal danger zone security

Reliable recognition of persons in danger zones when the light curtain is mounted at heights of 0.6 to 1 m

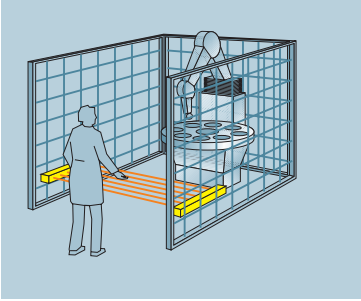

#### Device selection

Light curtains for Category 2 or 4 with 80 or 90 mm resolution

#### Applications

e.g. welding and assembly lines as well as welding and assembly robots in the automotive industry

### Light arrays for access security

Reliable detection of persons on entering danger zones

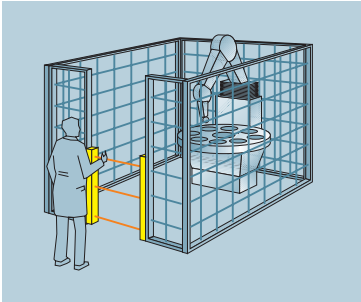

#### Device selection

2, 3 or 4-beam light arrays for Category 4 with 18 m range

#### Applications

Access protection, e.g. on robots or handling machines.

### Light arrays for access security for large areas

Reliable detection of persons on entering danger zones

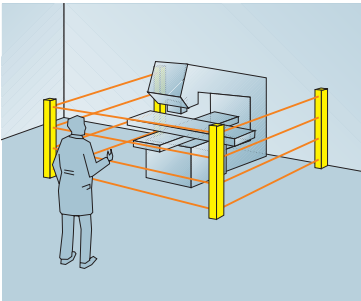

Securing large danger zones due to wide range of 60 m

#### Device selection

2, 3 or 4-beam light arrays for Category 4 with 60 m range

#### Applications

Access protection, e.g. on automatic machining centers or palleting machines.

### Safety categories

In accordance with the requirements placed on the safety category to EN 954-1 by the C standard or risk analysis for the machine or plant, light curtains or light arrays of Type 2 (up to Category 2) or Type 4 (up to Category 4).

## Design

A SIGUARD light curtain or light array comprises a transmitter and a receiver which must be mounted opposite each other. Depending on the resolution and the length, a certain number of transmit and receive diodes are arranged vertically. The infrared LEDs of the transmitter send out short light pulses which are detected by the receive diodes.

- 3RG78 42 light curtains and light arrays for Category 4 acc. to EN 954-1
  - 14, 30, 50 and 90 mm resolution,
  - Protective field heights from 150 to 3000 mm,
  - 2, 3 or 4-beam light arrays,
  - Cascading of host and guest devices for higher or longer protective fields or for angular arrangement (as an option).
- 3RG78 44 light curtains and light arrays with integrated evaluation for Category 4 acc. to EN 954-1
  - 14, 30 and 50 mm resolution,
  - Protective field heights from 150 mm to 3000 mm,
  - 2, 3 or 4-beam light arrays,
  - Cascading of host and guest devices for higher or longer protective fields or for angular arrangement (as an option).
- 3RG78 41 light curtains for Category 2 acc. to EN 954-1
  - 30, 55 and 80 mm resolution,
  - Protective field heights from 150 to 1800 mm,
  - Cascading of host and guest devices for higher or longer protective fields or for angular arrangement (as an option).

### Standards

- EN 61496-1, -2, IEC 61496-1, -2 (requirements for non-contact protection systems)
- EN 999 (incl. calculation of the safety clearances)
- EN 954-1 (safety of machines, safety-related parts of control systems).

## Functions

### Blanking

The light curtains can be supplied with a blanking function as an option.

### Fixed blanking

If an object is permanently located in the path of the light, the corresponding zone can be suppressed. This is achieved by suppressing the required number of beams.

The suppressed objects must be permanently located in the protective zone, otherwise safety cannot be guaranteed. The light curtain switches the equipment off.

Configuration is by means of a teach-in function with the help of safety keys.

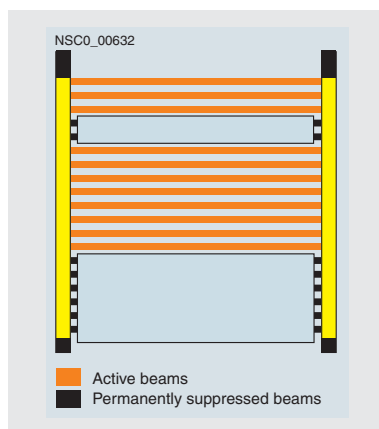

### Floating blanking

If moving objects are located in the light path, any number of light beams can be suppressed. The objects can move within the suppressed light beams without the light curtain switching off.

If the moving objects are removed from the zone, the light curtain will interrupt the dangerous motion, otherwise safety can no longer be guaranteed.

Configuration is by means of a Teach-in function with the help of safety keys.

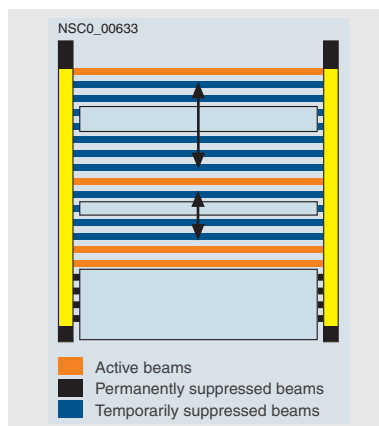

### Reduced resolution

If an object is located in the light path, two or three beams can be suppressed. The difference between reduced resolution and floating blanking is that there is no permanent monitoring in this case.

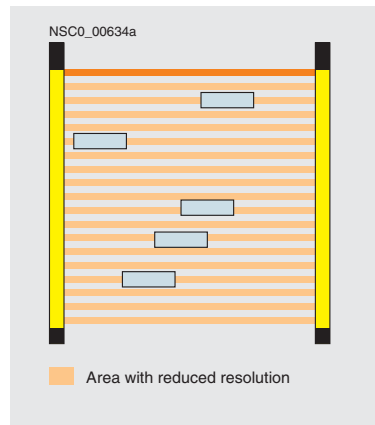

### Evaluation units

The 3RG78 47 SIGUARD evaluation units form a flexible product family of interface modules for the SIGUARD light curtains and light arrays. The modularly constructed product series can be implemented up to Category 4 according to EN 954-1.

The evaluation units expand the functional scope of the light curtains and light arrays with start-up and restart inhibiting and contactor control, and depending on the device variant also cycle control and muting.

The device type also offers comprehensive additional functions, such as a pre-trip warning for the relay contacts, a diagnostics function via the PC as well as numerous signaling outputs for connection to a higher-level PLC.

### PC software

The function of the light curtain as well as that of the evaluation units can be visualized and recorded using PC software.

### Mounting accessories

Installation, calibration, start-up and fault localization are aided by a wide range of practical accessories which include fixing columns, reflective mirror columns, reflective mirrors, brackets and laser alignment aids.

# SIGUARD Light Curtains and Arrays

## With Integrated Evaluation

### Light curtains and arrays to Category 4

#### Technical specifications

<b>Type</b>	<b>3RG78 44</b>
<b>Safety category</b> acc. to EN, IEC 61496-1, -2	Type 4
<b>Protective field height</b> • for 14 and 30 mm resolution • for 50 mm resolution	150 ... 1800 mm 450 ... 3000 mm
<b>Protective field width, range</b> • for 14 mm resolution • for 30 and 50 mm resolution	0.3 ... 6 m 0.8 ... 18 m
<b>Detection capability</b> (resolution)	14 mm, 30 mm, 50 mm
<b>Supply voltage</b> (transmitter and receiver)	DC 24 V, $\pm 20\%$ , (external power section with safe isolation from the supply and bridging of 20 ms voltage drop is necessary)
<b>Residual ripple</b>	< 5 %
<b>Current consumption</b> • Transmitter • Receiver	75 mA 180 mA (without external load)
General value for external fuse in the transmitter and receiver leads (not required when the power supply has its own fuse)	4 A
<b>Wave length</b>	880 nm (infra-red)
<b>Synchronization</b>	Optical between transmitter and receiver
<b>Ambient temperature</b> • Operation • Storage	0 ... +50 °C -25 ... +70 °C
<b>Relative humidity</b>	15 ... 95%
<b>Degree of protection</b>	IP65
<b>Safety class</b> acc. to DIN VDE 0106	III

#### Signal inputs and outputs (machine interface)

<b>Signal inputs</b> • Restart inhibit unlocking - min. operating time - max. operating time • Contactor control (EDM) - max. operating time	1 button with 1 NO, floating 300 ms 4 s two return contacts, floating 300 ms
<b>Signal outputs</b> • Restart inhibit - active - inactive • Fault indication - no fault - fault	+24 V, max. 60 mA 0 V +24 V, max. 60 mA 0 V

#### OSSDs response times ( $t_{AOPD}$ )

14 mm resolution		30 mm resolution		50 mm resolution	
n	$t_{AOPD\ eff}$	n	$t_{AOPD\ eff}$	n	$t_{AOPD\ eff}$
16	6.8 ms	8	10.2 ms		
24	10.0 ms	12	10.0 ms		
32	13.2 ms	16	6.8 ms		
48	9.8 ms	24	10.0 ms	12	10.0 ms
64	13.0 ms	32	13.2 ms	16	6.8 ms
80	16.2 ms	40	8.2 ms	20	8.4 ms
96	19.4 ms	48	9.8 ms	24	10.0 ms
112	22.6 ms	56	11.4 ms	28	11.6 ms
128	25.8 ms	64	13.0 ms	32	13.2 ms
144	29.0 ms	72	14.6 ms	36	7.4 ms
160	32.2 ms	80	16.2 ms	40	8.2 ms
176	35.4 ms	88	17.8 ms	44	9.0 ms
192	38.6 ms	96	19.4 ms	48	9.8 ms

$t_{AOPD\ eff}$  = Effective response time in AutoScan mode  
n = Number of light axes

#### Signal inputs and outputs (local socket, optional)

<b>Signal inputs</b> • Restart inhibit unlocking - min. operating time - max. operating time • Teach-in - Simultaneity	1 button with 1 NO, floating 300 ms 4 s 2-pole key-operated switch (selector switch), floating < 500 ms
<b>Voltage output</b> (only for command devices or safety sensors)	DC 24 V $\pm 20\%$ , max 0.5 A

#### Safety outputs (machine interface)

<b>OSSDs safety switching outputs</b>	2 safety-related pnp semiconductor outputs with crossover monitoring, short-circuit proof
<b>Switching voltage</b> • active high ( $U_B - 1\text{ V}$ ) • low	typically +23 V (+18.2 ... +27.8 V) 0 ... +2.5 V
<b>Switching current</b>	typically 500 mA; (max. 650 mA)
<b>Max. residual current</b>	0.1 mA
<b>Max. load capacitance</b>	200 nF
<b>Permissible line resistance</b> between receiver and load	20 $\Omega$
<b>Permissible lead length</b> between receiver and load (for 1 mm <sup>2</sup> )	100 m
<b>OSSDs response time</b> ( $t_{AOPD}$ )	Dependent on the number of light axes (see Table below)
<b>OSSDs reactivation time</b> after interruption of beam (without restart inhibit)	typically 100 ms, min. 80 ms, max. 5 s

# SIGUARD Light Curtains and Arrays With Integrated Evaluation

## Light curtains and arrays to Category 4

### Selection and ordering data

Height of light curtain	Version	DT	Function standard, transistor output	PS*	Weight per PU approx.	DT	Function blanking, transistor output	PS*	Weight per PU approx.
mm			Order No.		kg		Order No.		kg
<b>14 mm resolution, with cable gland</b>									
150	Receiver	A	<b>3RG78 44-6SB02-OSS1</b>	1 unit	0.700	A	<b>3RG78 44-6BB02-OSS1</b>	1 unit	0.700
	Transmitter	A	<b>3RG78 44-6SB02-OSS0</b>	1 unit	0.700	A	<b>3RG78 44-6SB02-OSS0</b>	1 unit	0.700
225	Receiver	A	<b>3RG78 44-6SB03-OSS1</b>	1 unit	0.900	A	<b>3RG78 44-6BB03-OSS1</b>	1 unit	0.900
	Transmitter	A	<b>3RG78 44-6SB03-OSS0</b>	1 unit	0.900	A	<b>3RG78 44-6SB03-OSS0</b>	1 unit	0.900
300	Receiver	A	<b>3RG78 44-6SB04-OSS1</b>	1 unit	1.100	A	<b>3RG78 44-6BB04-OSS1</b>	1 unit	1.100
	Transmitter	A	<b>3RG78 44-6SB04-OSS0</b>	1 unit	1.100	A	<b>3RG78 44-6SB04-OSS0</b>	1 unit	1.100
450	Receiver	A	<b>3RG78 44-6SB06-OSS1</b>	1 unit	1.500	A	<b>3RG78 44-6BB06-OSS1</b>	1 unit	1.500
	Transmitter	A	<b>3RG78 44-6SB06-OSS0</b>	1 unit	1.500	A	<b>3RG78 44-6SB06-OSS0</b>	1 unit	1.500
600	Receiver	A	<b>3RG78 44-6SB08-OSS1</b>	1 unit	1.900	A	<b>3RG78 44-6BB08-OSS1</b>	1 unit	1.900
	Transmitter	A	<b>3RG78 44-6SB08-OSS0</b>	1 unit	1.900	A	<b>3RG78 44-6SB08-OSS0</b>	1 unit	1.900
750	Receiver	A	<b>3RG78 44-6SB11-OSS1</b>	1 unit	2.300	A	<b>3RG78 44-6BB11-OSS1</b>	1 unit	2.300
	Transmitter	A	<b>3RG78 44-6SB11-OSS0</b>	1 unit	2.300	A	<b>3RG78 44-6SB11-OSS0</b>	1 unit	2.300
900	Receiver	A	<b>3RG78 44-6SB13-OSS1</b>	1 unit	2.700	A	<b>3RG78 44-6BB13-OSS1</b>	1 unit	2.700
	Transmitter	A	<b>3RG78 44-6SB13-OSS0</b>	1 unit	2.700	A	<b>3RG78 44-6SB13-OSS0</b>	1 unit	2.700
1050	Receiver	C	<b>3RG78 44-6SB15-OSS1</b>	1 unit	3.100	C	<b>3RG78 44-6BB15-OSS1</b>	1 unit	3.100
	Transmitter	C	<b>3RG78 44-6SB15-OSS0</b>	1 unit	3.100	C	<b>3RG78 44-6SB15-OSS0</b>	1 unit	3.100
1200	Receiver	C	<b>3RG78 44-6SB17-OSS1</b>	1 unit	3.500	C	<b>3RG78 44-6BB17-OSS1</b>	1 unit	3.500
	Transmitter	C	<b>3RG78 44-6SB17-OSS0</b>	1 unit	3.500	C	<b>3RG78 44-6SB17-OSS0</b>	1 unit	3.500
1350	Receiver	C	<b>3RG78 44-6SB20-OSS1</b>	1 unit	3.900	C	<b>3RG78 44-6BB20-OSS1</b>	1 unit	3.900
	Transmitter	C	<b>3RG78 44-6SB20-OSS0</b>	1 unit	3.900	C	<b>3RG78 44-6SB20-OSS0</b>	1 unit	3.900
1500	Receiver	C	<b>3RG78 44-6SB22-OSS1</b>	1 unit	4.300	C	<b>3RG78 44-6BB22-OSS1</b>	1 unit	4.300
	Transmitter	C	<b>3RG78 44-6SB22-OSS0</b>	1 unit	4.300	C	<b>3RG78 44-6SB22-OSS0</b>	1 unit	4.300
1650	Receiver	C	<b>3RG78 44-6SB24-OSS1</b>	1 unit	4.700	C	<b>3RG78 44-6BB24-OSS1</b>	1 unit	4.700
	Transmitter	C	<b>3RG78 44-6SB24-OSS0</b>	1 unit	4.700	C	<b>3RG78 44-6SB24-OSS0</b>	1 unit	4.700
1800	Receiver	C	<b>3RG78 44-6SB26-OSS1</b>	1 unit	5.100	C	<b>3RG78 44-6BB26-OSS1</b>	1 unit	5.100
	Transmitter	C	<b>3RG78 44-6SB26-OSS0</b>	1 unit	5.100	C	<b>3RG78 44-6SB26-OSS0</b>	1 unit	5.100
<b>30 mm resolution, with cable gland</b>									
150	Receiver	A	<b>3RG78 44-6SD02-OSS1</b>	1 unit	0.700	A	<b>3RG78 44-6BD02-OSS1</b>	1 unit	0.700
	Transmitter	A	<b>3RG78 44-6SD02-OSS0</b>	1 unit	0.700	A	<b>3RG78 44-6SD02-OSS0</b>	1 unit	0.700
225	Receiver	A	<b>3RG78 44-6SD03-OSS1</b>	1 unit	0.900	A	<b>3RG78 44-6BD03-OSS1</b>	1 unit	0.900
	Transmitter	A	<b>3RG78 44-6SD03-OSS0</b>	1 unit	0.900	A	<b>3RG78 44-6SD03-OSS0</b>	1 unit	0.900
300	Receiver	A	<b>3RG78 44-6SD04-OSS1</b>	1 unit	1.100	A	<b>3RG78 44-6BD04-OSS1</b>	1 unit	1.100
	Transmitter	A	<b>3RG78 44-6SD04-OSS0</b>	1 unit	1.100	A	<b>3RG78 44-6SD04-OSS0</b>	1 unit	1.100
450	Receiver	A	<b>3RG78 44-6SD06-OSS1</b>	1 unit	1.500	A	<b>3RG78 44-6BD06-OSS1</b>	1 unit	1.500
	Transmitter	A	<b>3RG78 44-6SD06-OSS0</b>	1 unit	1.500	A	<b>3RG78 44-6SD06-OSS0</b>	1 unit	1.500
600	Receiver	A	<b>3RG78 44-6SD08-OSS1</b>	1 unit	1.900	A	<b>3RG78 44-6BD08-OSS1</b>	1 unit	1.900
	Transmitter	A	<b>3RG78 44-6SD08-OSS0</b>	1 unit	1.900	A	<b>3RG78 44-6SD08-OSS0</b>	1 unit	1.900
750	Receiver	A	<b>3RG78 44-6SD11-OSS1</b>	1 unit	2.300	A	<b>3RG78 44-6BD11-OSS1</b>	1 unit	2.300
	Transmitter	A	<b>3RG78 44-6SD11-OSS0</b>	1 unit	2.300	A	<b>3RG78 44-6SD11-OSS0</b>	1 unit	2.300
900	Receiver	A	<b>3RG78 44-6SD13-OSS1</b>	1 unit	2.700	A	<b>3RG78 44-6BD13-OSS1</b>	1 unit	2.700
	Transmitter	A	<b>3RG78 44-6SD13-OSS0</b>	1 unit	2.700	A	<b>3RG78 44-6SD13-OSS0</b>	1 unit	2.700
1050	Receiver	C	<b>3RG78 44-6SD15-OSS1</b>	1 unit	3.100	C	<b>3RG78 44-6BD15-OSS1</b>	1 unit	3.100
	Transmitter	C	<b>3RG78 44-6SD15-OSS0</b>	1 unit	3.100	C	<b>3RG78 44-6SD15-OSS0</b>	1 unit	3.100
1200	Receiver	C	<b>3RG78 44-6SD17-OSS1</b>	1 unit	3.500	C	<b>3RG78 44-6BD17-OSS1</b>	1 unit	3.500
	Transmitter	C	<b>3RG78 44-6SD17-OSS0</b>	1 unit	3.500	C	<b>3RG78 44-6SD17-OSS0</b>	1 unit	3.500
1350	Receiver	C	<b>3RG78 44-6SD20-OSS1</b>	1 unit	3.900	C	<b>3RG78 44-6BD20-OSS1</b>	1 unit	3.900
	Transmitter	C	<b>3RG78 44-6SD20-OSS0</b>	1 unit	3.900	C	<b>3RG78 44-6SD20-OSS0</b>	1 unit	3.900
1500	Receiver	C	<b>3RG78 44-6SD22-OSS1</b>	1 unit	4.300	C	<b>3RG78 44-6BD22-OSS1</b>	1 unit	4.300
	Transmitter	C	<b>3RG78 44-6SD22-OSS0</b>	1 unit	4.300	C	<b>3RG78 44-6SD22-OSS0</b>	1 unit	4.300
1650	Receiver	C	<b>3RG78 44-6SD24-OSS1</b>	1 unit	4.700	C	<b>3RG78 44-6BD24-OSS1</b>	1 unit	4.700
	Transmitter	C	<b>3RG78 44-6SD24-OSS0</b>	1 unit	4.700	C	<b>3RG78 44-6SD24-OSS0</b>	1 unit	4.700
1800	Receiver	C	<b>3RG78 44-6SD26-OSS1</b>	1 unit	5.100	C	<b>3RG78 44-6BD26-OSS1</b>	1 unit	5.100
	Transmitter	C	<b>3RG78 44-6SD26-OSS0</b>	1 unit	5.100	C	<b>3RG78 44-6SD26-OSS0</b>	1 unit	5.100

Two standard mounting brackets are supplied with all 3RG78 44 devices (they can also be ordered as an accessory under the Order No. 3RG78 48-0AB).

# SIGUARD Light Curtains and Arrays With Integrated Evaluation

## Light curtains and arrays to Category 4

Height of light curtain	Version	DT	Function standard, transistor output	PS*	Weight per PU approx.	DT	Function blanking, transistor output	PS*	Weight per PU approx.
mm			Order No.		kg		Order No.		kg
<b>50 mm resolution, with cable gland</b>									
450	Receiver	A	<b>3RG78 44-6SE06-OSS1</b>	1 unit	1,500	A	<b>3RG78 44-6BE06-OSS1</b>	1 unit	1,500
	Transmitter	A	<b>3RG78 44-6SE06-OSS0</b>	1 unit	1,500	A	<b>3RG78 44-6BE06-OSS0</b>	1 unit	1,500
600	Receiver	A	<b>3RG78 44-6SE08-OSS1</b>	1 unit	1,900	A	<b>3RG78 44-6BE08-OSS1</b>	1 unit	1,900
	Transmitter	A	<b>3RG78 44-6SE08-OSS0</b>	1 unit	1,900	A	<b>3RG78 44-6BE08-OSS0</b>	1 unit	1,900
750	Receiver	A	<b>3RG78 44-6SE11-OSS1</b>	1 unit	2,300	A	<b>3RG78 44-6BE11-OSS1</b>	1 unit	2,300
	Transmitter	A	<b>3RG78 44-6SE11-OSS0</b>	1 unit	2,300	A	<b>3RG78 44-6BE11-OSS0</b>	1 unit	2,300
900	Receiver	A	<b>3RG78 44-6SE13-OSS1</b>	1 unit	2,700	A	<b>3RG78 44-6BE13-OSS1</b>	1 unit	2,700
	Transmitter	A	<b>3RG78 44-6SE13-OSS0</b>	1 unit	2,700	A	<b>3RG78 44-6BE13-OSS0</b>	1 unit	2,700
1050	Receiver	C	<b>3RG78 44-6SE15-OSS1</b>	1 unit	3,100	C	<b>3RG78 44-6BE15-OSS1</b>	1 unit	3,100
	Transmitter	C	<b>3RG78 44-6SE15-OSS0</b>	1 unit	3,100	C	<b>3RG78 44-6BE15-OSS0</b>	1 unit	3,100
1200	Receiver	C	<b>3RG78 44-6SE17-OSS1</b>	1 unit	3,500	C	<b>3RG78 44-6BE17-OSS1</b>	1 unit	3,500
	Transmitter	C	<b>3RG78 44-6SE17-OSS0</b>	1 unit	3,500	C	<b>3RG78 44-6BE17-OSS0</b>	1 unit	3,500
1350	Receiver	C	<b>3RG78 44-6SE20-OSS1</b>	1 unit	3,900	C	<b>3RG78 44-6BE20-OSS1</b>	1 unit	3,900
	Transmitter	C	<b>3RG78 44-6SE20-OSS0</b>	1 unit	3,900	C	<b>3RG78 44-6BE20-OSS0</b>	1 unit	3,900
1500	Receiver	C	<b>3RG78 44-6SE22-OSS1</b>	1 unit	4,300	C	<b>3RG78 44-6BE22-OSS1</b>	1 unit	4,300
	Transmitter	C	<b>3RG78 44-6SE22-OSS0</b>	1 unit	4,300	C	<b>3RG78 44-6BE22-OSS0</b>	1 unit	4,300
1650	Receiver	C	<b>3RG78 44-6SE24-OSS1</b>	1 unit	4,700	C	<b>3RG78 44-6BE24-OSS1</b>	1 unit	4,700
	Transmitter	C	<b>3RG78 44-6SE24-OSS0</b>	1 unit	4,700	C	<b>3RG78 44-6BE24-OSS0</b>	1 unit	4,700
1800	Receiver	C	<b>3RG78 44-6SE26-OSS1</b>	1 unit	5,100	C	<b>3RG78 44-6BE26-OSS1</b>	1 unit	5,100
	Transmitter	C	<b>3RG78 44-6SE26-OSS0</b>	1 unit	5,100	C	<b>3RG78 44-6BE26-OSS0</b>	1 unit	5,100
2100	Receiver	C	<b>3RG78 44-6SE28-OSS1</b>	1 unit	5,900	C	<b>3RG78 44-6BE28-OSS1</b>	1 unit	5,900
	Transmitter	C	<b>3RG78 44-6SE28-OSS0</b>	1 unit	5,900	C	<b>3RG78 44-6BE28-OSS0</b>	1 unit	5,900
2400	Receiver	C	<b>3RG78 44-6SE31-OSS1</b>	1 unit	6,700	C	<b>3RG78 44-6BE31-OSS1</b>	1 unit	6,700
	Transmitter	C	<b>3RG78 44-6SE31-OSS0</b>	1 unit	6,700	C	<b>3RG78 44-6BE31-OSS0</b>	1 unit	6,700
2700	Receiver	C	<b>3RG78 44-6SE33-OSS1</b>	1 unit	7,500	C	<b>3RG78 44-6BE33-OSS1</b>	1 unit	7,500
	Transmitter	C	<b>3RG78 44-6SE33-OSS0</b>	1 unit	7,500	C	<b>3RG78 44-6BE33-OSS0</b>	1 unit	7,500
3000	Receiver	C	<b>3RG78 44-6SE35-OSS1</b>	1 unit	8,300	C	<b>3RG78 44-6BE35-OSS1</b>	1 unit	8,300
	Transmitter	C	<b>3RG78 44-6SE35-OSS0</b>	1 unit	8,300	C	<b>3RG78 44-6BE35-OSS0</b>	1 unit	8,300



Light beams	Beam spacing	DT	Sensing range 18 m	PS*	Weight per PU approx.	DT	Sensing range 70 m	PS*	Weight per PU approx.
Number	mm		Order No.		kg		Order No.		kg
<b>Light array with cable gland</b>									
2-beam	500	Receiver	<b>3RG78 44-6SS50-OSS1</b>	1 unit	1,900	A	<b>3RG78 44-6SS51-OSS1</b>	1 unit	1,900
		Transmitter	<b>3RG78 44-6SS50-OSS0</b>	1 unit	1,900	A	<b>3RG78 44-6SS51-OSS0</b>	1 unit	1,900
3-beam	400	Receiver	<b>3RG78 44-6SP50-OSS1</b>	1 unit	2,700	A	<b>3RG78 44-6SP51-OSS1</b>	1 unit	2,700
		Transmitter	<b>3RG78 44-6SP50-OSS0</b>	1 unit	2,700	A	<b>3RG78 44-6SP51-OSS0</b>	1 unit	2,700
4-beam	300	Receiver	<b>3RG78 44-6SM50-OSS1</b>	1 unit	3,100	A	<b>3RG78 44-6SM51-OSS1</b>	1 unit	3,100
		Transmitter	<b>3RG78 44-6SM50-OSS0</b>	1 unit	3,100	A	<b>3RG78 44-6SM51-OSS0</b>	1 unit	3,100

Two standard mounting brackets are supplied with all 3RG78 44 devices (they can also be ordered as an accessory under the Order No. 3RG78 48-0AB).



# SIGUARD Light Curtains and Arrays

## With Integrated Evaluation

### Light curtains and arrays to Category 4

Height of light curtain	Version	DT	Function standard, relay output	PS*	Weight per PU approx.	DT	Function blanking, relay output	PS*	Weight per PU approx.
mm			Order No.		kg		Order No.		kg

#### 14 mm resolution, with Hirschmann plug connector

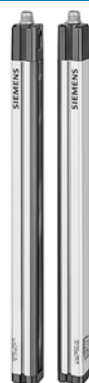

300	Receiver	C	<b>3RG78 44-8SB04-OSS1</b>	1 unit	1.100	C	<b>3RG78 44-8BB04-OSS1</b>	1 unit	1.100
300	Transmitter	C	<b>3RG78 44-2SB04-OSS0</b>	1 unit	1.100	C	<b>3RG78 44-2SB04-OSS0</b>	1 unit	1.100
450	Receiver	C	<b>3RG78 44-8SB06-OSS1</b>	1 unit	1.500	C	<b>3RG78 44-8BB06-OSS1</b>	1 unit	1.500
450	Transmitter	C	<b>3RG78 44-2SB06-OSS0</b>	1 unit	1.500	C	<b>3RG78 44-2SB06-OSS0</b>	1 unit	1.500
600	Receiver	C	<b>3RG78 44-8SB08-OSS1</b>	1 unit	1.900	C	<b>3RG78 44-8BB08-OSS1</b>	1 unit	1.900
600	Transmitter	C	<b>3RG78 44-2SB08-OSS0</b>	1 unit	1.900	C	<b>3RG78 44-2SB08-OSS0</b>	1 unit	1.900
750	Receiver	C	<b>3RG78 44-8SB11-OSS1</b>	1 unit	2.300	C	<b>3RG78 44-8BB11-OSS1</b>	1 unit	2.300
750	Transmitter	C	<b>3RG78 44-2SB11-OSS0</b>	1 unit	2.300	C	<b>3RG78 44-2SB11-OSS0</b>	1 unit	2.300
900	Receiver	C	<b>3RG78 44-8SB13-OSS1</b>	1 unit	2.700	C	<b>3RG78 44-8BB13-OSS1</b>	1 unit	2.700
900	Transmitter	C	<b>3RG78 44-2SB13-OSS0</b>	1 unit	2.700	C	<b>3RG78 44-2SB13-OSS0</b>	1 unit	2.700
1050	Receiver	C	<b>3RG78 44-8SB15-OSS1</b>	1 unit	3.100	C	<b>3RG78 44-8BB15-OSS1</b>	1 unit	3.100
1050	Transmitter	C	<b>3RG78 44-2SB15-OSS0</b>	1 unit	3.100	C	<b>3RG78 44-2SB15-OSS0</b>	1 unit	3.100
1200	Receiver	C	<b>3RG78 44-8SB17-OSS1</b>	1 unit	3.500	C	<b>3RG78 44-8BB17-OSS1</b>	1 unit	3.500
1200	Transmitter	C	<b>3RG78 44-2SB17-OSS0</b>	1 unit	3.500	C	<b>3RG78 44-2SB17-OSS0</b>	1 unit	3.500

#### 30 mm resolution, with Hirschmann plug connector



300	Receiver	C	<b>3RG78 44-8SD04-OSS1</b>	1 unit	1.100	C	<b>3RG78 44-8BD04-OSS1</b>	1 unit	1.100
300	Transmitter	C	<b>3RG78 44-2SD04-OSS0</b>	1 unit	1.100	C	<b>3RG78 44-2SD04-OSS0</b>	1 unit	1.100
450	Receiver	C	<b>3RG78 44-8SD06-OSS1</b>	1 unit	1.500	C	<b>3RG78 44-8BD06-OSS1</b>	1 unit	1.500
450	Transmitter	C	<b>3RG78 44-2SD06-OSS0</b>	1 unit	1.500	C	<b>3RG78 44-2SD06-OSS0</b>	1 unit	1.500
600	Receiver	C	<b>3RG78 44-8SD08-OSS1</b>	1 unit	1.900	C	<b>3RG78 44-8BD08-OSS1</b>	1 unit	1.900
600	Transmitter	C	<b>3RG78 44-2SD08-OSS0</b>	1 unit	1.900	C	<b>3RG78 44-2SD08-OSS0</b>	1 unit	1.900
750	Receiver	C	<b>3RG78 44-8SD11-OSS1</b>	1 unit	2.300	C	<b>3RG78 44-8BD11-OSS1</b>	1 unit	2.300
750	Transmitter	C	<b>3RG78 44-2SD11-OSS0</b>	1 unit	2.300	C	<b>3RG78 44-2SD11-OSS0</b>	1 unit	2.300
900	Receiver	C	<b>3RG78 44-8SD13-OSS1</b>	1 unit	2.700	C	<b>3RG78 44-8BD13-OSS1</b>	1 unit	2.700
900	Transmitter	C	<b>3RG78 44-2SD13-OSS0</b>	1 unit	2.700	C	<b>3RG78 44-2SD13-OSS0</b>	1 unit	2.700
1050	Receiver	C	<b>3RG78 44-8SD15-OSS1</b>	1 unit	3.100	C	<b>3RG78 44-8BD15-OSS1</b>	1 unit	3.100
1050	Transmitter	C	<b>3RG78 44-2SD15-OSS0</b>	1 unit	3.100	C	<b>3RG78 44-2SD15-OSS0</b>	1 unit	3.100
1200	Receiver	C	<b>3RG78 44-8SD17-OSS1</b>	1 unit	3.500	C	<b>3RG78 44-8BD17-OSS1</b>	1 unit	3.500
1200	Transmitter	C	<b>3RG78 44-2SD17-OSS0</b>	1 unit	3.500	C	<b>3RG78 44-2SD17-OSS0</b>	1 unit	3.500
1350	Receiver	C	<b>3RG78 44-8SD20-OSS1</b>	1 unit	3.900	C	<b>3RG78 44-8BD20-OSS1</b>	1 unit	3.900
1350	Transmitter	C	<b>3RG78 44-2SD20-OSS0</b>	1 unit	3.900	C	<b>3RG78 44-2SD20-OSS0</b>	1 unit	3.900
1500	Receiver	C	<b>3RG78 44-8SD22-OSS1</b>	1 unit	4.300	C	<b>3RG78 44-8BD22-OSS1</b>	1 unit	4.300
1500	Transmitter	C	<b>3RG78 44-2SD22-OSS0</b>	1 unit	4.300	C	<b>3RG78 44-2SD22-OSS0</b>	1 unit	4.300
1650	Receiver	C	<b>3RG78 44-8SD24-OSS1</b>	1 unit	4.700	C	<b>3RG78 44-8BD24-OSS1</b>	1 unit	4.700
1650	Transmitter	C	<b>3RG78 44-2SD24-OSS0</b>	1 unit	4.700	C	<b>3RG78 44-2SD24-OSS0</b>	1 unit	4.700
1800	Receiver	C	<b>3RG78 44-8SD26-OSS1</b>	1 unit	5.100	C	<b>3RG78 44-8BD26-OSS1</b>	1 unit	5.100
1800	Transmitter	C	<b>3RG78 44-2SD26-OSS0</b>	1 unit	5.100	C	<b>3RG78 44-2SD26-OSS0</b>	1 unit	5.100

Light beams	Beam spacing	DT	Function standard, relay output	PS*	Weight per PU approx.
Number	mm		Order No.		kg

#### Light array, sensing range 18 m

2-beam	500	Receiver	C	<b>3RG78 44-8SS50-OSS1</b>	1 unit	1.900
		Transmitter	C	<b>3RG78 44-2SS50-OSS0</b>	1 unit	1.900
3-beam	400	Receiver	C	<b>3RG78 44-8SP50-OSS1</b>	1 unit	2.700
		Transmitter	C	<b>3RG78 44-2SP50-OSS0</b>	1 unit	2.700
4-beam	300	Receiver	C	<b>3RG78 44-8SM50-OSS1</b>	1 unit	3.100
		Transmitter	C	<b>3RG78 44-2SM50-OSS0</b>	1 unit	3.100

Two standard mounting brackets are supplied with all 3RG78 44 devices (they can also be ordered as an accessory under the Order No. 3RG78 48-0AB).

The devices with relay output will be available for delivery from January 2004.

# SIGUARD Light Curtains and Arrays

## With Integrated Evaluation

### Light curtains and arrays to Category 4

Height of light curtain mm	Version	DT	Function muting, transistor output, cable gland	PS*	Weight per PU approx. kg	DT	Function muting, relay output, Hirschmann plug connector	PS*	Weight per PU approx. kg
			Order No.				Order No.		
<b>30 mm resolution</b>									
300	Receiver	A	<b>3RG78 44-6MD04-OSS1</b>	1 unit	1.100	C	<b>3RG78 44-8MD04-OSS1</b>	1 unit	1.100
	Transmitter	A	<b>3RG78 44-6SD04-OSS0</b>	1 unit	1.100	C	<b>3RG78 44-2SD04-OSS0</b>	1 unit	1.100
450	Receiver	A	<b>3RG78 44-6MD06-OSS1</b>	1 unit	1.500	C	<b>3RG78 44-8MD06-OSS1</b>	1 unit	1.500
	Transmitter	A	<b>3RG78 44-6SD06-OSS0</b>	1 unit	1.500	C	<b>3RG78 44-2SD06-OSS0</b>	1 unit	1.500
600	Receiver	A	<b>3RG78 44-6MD08-OSS1</b>	1 unit	1.900	C	<b>3RG78 44-8MD08-OSS1</b>	1 unit	1.900
	Transmitter	A	<b>3RG78 44-6SD08-OSS0</b>	1 unit	1.900	C	<b>3RG78 44-2SD08-OSS0</b>	1 unit	1.900
750	Receiver	A	<b>3RG78 44-6MD11-OSS1</b>	1 unit	2.300	C	<b>3RG78 44-8MD11-OSS1</b>	1 unit	2.300
	Transmitter	A	<b>3RG78 44-6SD11-OSS0</b>	1 unit	2.300	C	<b>3RG78 44-2SD11-OSS0</b>	1 unit	2.300
900	Receiver	A	<b>3RG78 44-6MD13-OSS1</b>	1 unit	2.700	C	<b>3RG78 44-8MD13-OSS1</b>	1 unit	2.700
	Transmitter	A	<b>3RG78 44-6SD13-OSS0</b>	1 unit	2.700	C	<b>3RG78 44-2SD13-OSS0</b>	1 unit	2.700
1050	Receiver	C	<b>3RG78 44-6MD15-OSS1</b>	1 unit	3.100	C	<b>3RG78 44-8MD15-OSS1</b>	1 unit	3.100
	Transmitter	C	<b>3RG78 44-6SD15-OSS0</b>	1 unit	3.100	C	<b>3RG78 44-2SD15-OSS0</b>	1 unit	3.100
1200	Receiver	C	<b>3RG78 44-6MD17-OSS1</b>	1 unit	3.500	C	<b>3RG78 44-8MD17-OSS1</b>	1 unit	3.500
	Transmitter	C	<b>3RG78 44-6SD17-OSS0</b>	1 unit	3.500	C	<b>3RG78 44-2SD17-OSS0</b>	1 unit	3.500
1350	Receiver	C	<b>3RG78 44-6MD20-OSS1</b>	1 unit	3.900	C	<b>3RG78 44-8MD20-OSS1</b>	1 unit	3.900
	Transmitter	C	<b>3RG78 44-6SD20-OSS0</b>	1 unit	3.900	C	<b>3RG78 44-2SD20-OSS0</b>	1 unit	3.900
1500	Receiver	C	<b>3RG78 44-6MD22-OSS1</b>	1 unit	4.300	C	<b>3RG78 44-8MD22-OSS1</b>	1 unit	4.300
	Transmitter	C	<b>3RG78 44-6SD22-OSS0</b>	1 unit	4.300	C	<b>3RG78 44-2SD22-OSS0</b>	1 unit	4.300
1650	Receiver	C	<b>3RG78 44-6MD24-OSS1</b>	1 unit	4.700	C	<b>3RG78 44-8MD24-OSS1</b>	1 unit	4.700
	Transmitter	C	<b>3RG78 44-6SD24-OSS0</b>	1 unit	4.700	C	<b>3RG78 44-2SD24-OSS0</b>	1 unit	4.700
1800	Receiver	C	<b>3RG78 44-6MD26-OSS1</b>	1 unit	5.100	C	<b>3RG78 44-8MD26-OSS1</b>	1 unit	5.100
	Transmitter	C	<b>3RG78 44-6SD26-OSS0</b>	1 unit	5.100	C	<b>3RG78 44-2SD26-OSS0</b>	1 unit	5.100

Light beams Number	Beam spacing mm	DT	Function muting, transistor output, cable gland	PS*	Weight per PU approx. kg	DT	Function Muting, relay output, Hirschmann plug connector	PS*	Weight per PU approx. kg	
			Order No.				Order No.			
<b>Light array, sensing range 18 m</b>										
2-beam	500	Receiver	A	<b>3RG78 44-6MS50-OSS1</b>	1 unit	1.900	C	<b>3RG78 44-8MS50-OSS1</b>	1 unit	1.900
		Transmitter	A	<b>3RG78 44-6SS50-OSS0</b>	1 unit	1.900	C	<b>3RG78 44-2SS50-OSS0</b>	1 unit	1.900
3-beam	400	Receiver	A	<b>3RG78 44-6MP50-OSS1</b>	1 unit	1.900	C	<b>3RG78 44-8MP50-OSS1</b>	1 unit	1.900
		Transmitter	A	<b>3RG78 44-6SP50-OSS0</b>	1 unit	2.700	C	<b>3RG78 44-2SP50-OSS0</b>	1 unit	2.700
4-beam	300	Receiver	A	<b>3RG78 44-6MM50-OSS1</b>	1 unit	1.900	C	<b>3RG78 44-8MM50-OSS1</b>	1 unit	1.900
		Transmitter	A	<b>3RG78 44-6SM50-OSS0</b>	1 unit	3.100	C	<b>3RG78 44-2SM50-OSS0</b>	1 unit	3.100

<b>Light array, sensing range 8 m</b>										
2-beam	500	Transceiver	A	<b>3RG78 44-6MS50-OST0</b>	1 unit	1.900	C	<b>3RG78 44-8MS50-OST0</b>	1 unit	1.900
Reflective mirrors			A	<b>3RG78 48-OTL</b>	1 unit	1.500	A	<b>3RG78 48-OTL</b>	1 unit	1.500

Two standard mounting brackets are supplied with all 3RG78 44 devices (they can also be ordered as an accessory under the Order No. 3RG78 48-0AB). Devices with muting function will be available for delivery from January 2004.

### Dimension drawings

**3RG78 44 standard light curtains,  
3RG78 44 light arrays**

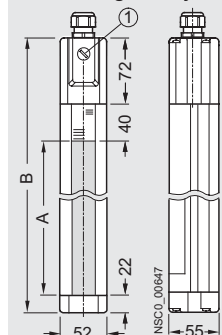

- ① Pg 9 sealing cap (receiver only, for local interface)
- A Protective field height (see Selection and ordering data)
- B Overall length = protective field A + 134 mm

**3RG78 44 light arrays**

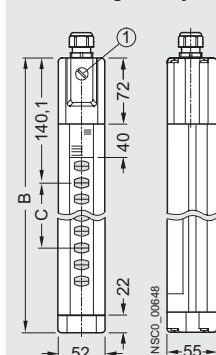

Additional dimensions for light array only:

Type	B	C	Beams
3RG78 44-..M	1184	300	4
3RG78 44-..P	1034	400	3
3RG78 44-..S	734	500	2

**3RG78 48-OTL reflective mirror**

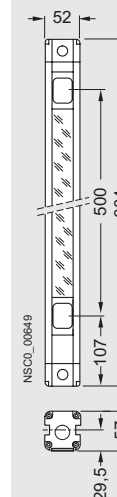



# SIGUARD Light Curtains and Arrays With Separate Evaluation Unit

## Light curtains and arrays to Category 4

### Technical specifications

<b>Type</b>	<b>3RG78 42</b>
<b>Safety category</b> acc. to EN, IEC 61496-1, -2	Type 4 (self-monitoring)
<b>Detection capability</b> (resolution)	14 mm, 30 mm, 50 mm, 90 mm or whole person with 2, 3 or 4 beams
<b>Protective field height</b>	
• for 14 and 30 mm resolution	150 ... 1800 mm
• for 50 mm resolution	450 ... 3000 mm
• for 90 mm resolution	750 ... 3000 mm
<b>Protective field width, range</b>	
• for 14 mm resolution	0.3 ... 6 m
• for 30, 50 and 90 mm resolution	0.8 ... 18 m
• for 18 m light array	0.8 ... 18 m
• for 60 m light array	6 ... 60 m
<b>Supply voltage</b> (transmitter and receiver)	DC 24 V $\pm$ 20 % (external power section with safe isolation from the supply and 20 ms bridging of supply failures)
<b>Current consumption</b>	
• Transmitter	75 mA
• Receiver	180 mA (without external load)
<b>Infrared light interference suppression</b>	2 techniques selectable
• Standard	high suppression
• d-scan	extremely high suppression (response time rises with devices with more than 15 beams)
<b>Synchronization</b> between transmitter and receiver	optical; 2 selectable transmission channels
<b>Ambient temperature</b>	
• Operation	0 ... +55 °C
• Storage	-25 ... +70 °C
<b>Air humidity</b>	15 ... 95%
<b>Degree of protection</b>	IP65
<b>Electrical connection</b>	Via Pg 13 screw terminals and plug-in connection
<b>Connecting cable</b>	
• Transmitter	7-pole, 0.5 ... 1.0 mm <sup>2</sup>
• Receiver	7-pole, 0.5 ... 1.0 mm <sup>2</sup> (screened if required)
<b>Cable length</b> for 1.0 mm <sup>2</sup>	100 m

### Inputs

<b>Transmitter test input</b>	Closed-circuit principle
<b>Minimum opening time</b>	50 ms

### Outputs

<b>Safety outputs</b>	2 failsafe pnp outputs with crossover monitoring, short-circuit proof
<b>Output voltage</b> $U_{a \text{ min}}$	$U_{\text{vers}} - 2.7 \text{ V}$
<b>Output current</b> $I_{a \text{ max}}$	0.3 A
<b>Peak current</b>	0.4 A
<b>Continuous thermal current</b>	
• at 35 °C	0.3 A
• at 55 °C	0.22 A
<b>Max. load capacitance per output</b>	300 nF (100 nF for channel 2)
<b>Response time</b> from interruption of protective field until safety outputs switch off	Rises as number of beams increase
• for 14 mm resolution	7 ... 39 ms (d-scan 10 ... 78 ms)
• for 30 mm resolution	7 ... 20 ms (d-scan 10 ... 39 ms)
• for 50 mm resolution	17 ms (d-scan 33 ms)
• for 90 mm resolution	13 ms (d-scan 20 ms)
• For light array 2-, 3- or 4-beam	5 ms (d-scan 8 ms)
<b>Reactivation time</b> from enabling the protective field until safety outputs switch on	
• For all resolutions	0.5 ms
• For extremely brief interruptions of the protective field	100 ms
<b>Pollution output and fault signaling output</b>	pnp output, short-circuit proof
<b>Output current, max.</b>	70 mA
<b>Safety and diagnostic interface</b>	RS-485, 57.6 Kbaud

# SIGUARD Light Curtains and Arrays

## With Separate Evaluation Unit

### Light curtains and arrays to Category 4

#### Selection and ordering data

Protective field height	DT	14 mm resolution	PS*	Weight per PU approx.	DT	30 mm resolution	PS*	Weight per PU approx.
mm		Order No.		kg		Order No.		kg

#### Standard light curtains



#### Type 4 according to IEC 61496-1,-2

150	Receiver	A	<b>3RG78 42-6BB01</b>	1 unit	1.430	A	<b>3RG78 42-6DB01</b>	1 unit	0.660
	Transmitter	A	<b>3RG78 42-6BB00</b>	1 unit	1.130	A	<b>3RG78 42-6DB00</b>	1 unit	1.150
225	Receiver	A	<b>3RG78 42-6BC01</b>	1 unit	1.890	A	<b>3RG78 42-6DC01</b>	1 unit	1.670
	Transmitter	A	<b>3RG78 42-6BC00</b>	1 unit	1.440	A	<b>3RG78 42-6DC00</b>	1 unit	1.410
300	Receiver	A	<b>3RG78 42-6BD01</b>	1 unit	1.870	A	<b>3RG78 42-6DD01</b>	1 unit	1.870
	Transmitter	A	<b>3RG78 42-6BD00</b>	1 unit	1.620	A	<b>3RG78 42-6DD00</b>	1 unit	1.600
450	Receiver	A	<b>3RG78 42-6BE01</b>	1 unit	2.250	A	<b>3RG78 42-6DE01</b>	1 unit	2.200
	Transmitter	A	<b>3RG78 42-6BE00</b>	1 unit	2.030	A	<b>3RG78 42-6DE00</b>	1 unit	1.980
600	Receiver	A	<b>3RG78 42-6BF01</b>	1 unit	2.700	A	<b>3RG78 42-6DF01</b>	1 unit	2.660
	Transmitter	A	<b>3RG78 42-6BF00</b>	1 unit	2.500	A	<b>3RG78 42-6DF00</b>	1 unit	2.450
750	Receiver	A	<b>3RG78 42-6BG01</b>	1 unit	3.190	A	<b>3RG78 42-6DG01</b>	1 unit	3.030
	Transmitter	A	<b>3RG78 42-6BG00</b>	1 unit	2.960	A	<b>3RG78 42-6DG00</b>	1 unit	2.790
900	Receiver	A	<b>3RG78 42-6BH01</b>	1 unit	3.500	A	<b>3RG78 42-6DH01</b>	1 unit	3.450
	Transmitter	A	<b>3RG78 42-6BH00</b>	1 unit	3.280	A	<b>3RG78 42-6DH00</b>	1 unit	3.230
1025	Receiver	C	<b>3RG78 42-6BJ01</b>	1 unit	4.170	C	<b>3RG78 42-6DJ01</b>	1 unit	3.880
	Transmitter	C	<b>3RG78 42-6BJ00</b>	1 unit	3.900	C	<b>3RG78 42-6DJ00</b>	1 unit	3.880
1200	Receiver	C	<b>3RG78 42-6BK01</b>	1 unit	4.630	C	<b>3RG78 42-6DK01</b>	1 unit	4.500
	Transmitter	C	<b>3RG78 42-6BK00</b>	1 unit	4.420	C	<b>3RG78 42-6DK00</b>	1 unit	4.280
1350	Receiver	C	<b>3RG78 42-6BL01</b>	1 unit	5.200	C	<b>3RG78 42-6DL01</b>	1 unit	5.060
	Transmitter	C	<b>3RG78 42-6BL00</b>	1 unit	4.840	C	<b>3RG78 42-6DL00</b>	1 unit	4.730
1500	Receiver	C	<b>3RG78 42-6BM01</b>	1 unit	5.590	C	<b>3RG78 42-6DM01</b>	1 unit	5.840
	Transmitter	C	<b>3RG78 42-6BM00</b>	1 unit	5.350	C	<b>3RG78 42-6DM00</b>	1 unit	5.200
1650	Receiver	C	<b>3RG78 42-6BN01</b>	1 unit	0.100	C	<b>3RG78 42-6DN01</b>	1 unit	5.760
	Transmitter	C	<b>3RG78 42-6BN00</b>	1 unit	0.100	C	<b>3RG78 42-6DN00</b>	1 unit	5.670
1800	Receiver	C	<b>3RG78 42-6BP01</b>	1 unit	0.100	C	<b>3RG78 42-6DP01</b>	1 unit	6.410
	Transmitter	C	<b>3RG78 42-6BP00</b>	1 unit	0.100	C	<b>3RG78 42-6DP00</b>	1 unit	6.150

Protective field height	DT	50 mm resolution	PS*	Weight per PU approx.	DT	90 mm resolution	PS*	Weight per PU approx.
mm		Order No.		kg		Order No.		kg

#### Standard light curtains



#### Type 4 according to IEC 61496-1,-2

450	Receiver	A	<b>3RG78 42-6EE01</b>	1 unit	2.200	-	-	-	
	Transmitter	A	<b>3RG78 42-6EE00</b>	1 unit	1.900	-	-	-	
600	Receiver	A	<b>3RG78 42-6EF01</b>	1 unit	2.440	-	-	-	
	Transmitter	A	<b>3RG78 42-6EF00</b>	1 unit	2.440	-	-	-	
750	Receiver	A	<b>3RG78 42-6EG01</b>	1 unit	3.000	A	<b>3RG78 42-6JG01</b>	1 unit	3.170
	Transmitter	A	<b>3RG78 42-6EG00</b>	1 unit	2.900	A	<b>3RG78 42-6JG00</b>	1 unit	2.950
900	Receiver	A	<b>3RG78 42-6EH01</b>	1 unit	3.500	A	<b>3RG78 42-6JH01</b>	1 unit	3.650
	Transmitter	A	<b>3RG78 42-6EH00</b>	1 unit	3.300	A	<b>3RG78 42-6JH00</b>	1 unit	3.430
1050	Receiver	C	<b>3RG78 42-6EJ01</b>	1 unit	4.030	C	<b>3RG78 42-6JJ01</b>	1 unit	4.010
	Transmitter	C	<b>3RG78 42-6EJ00</b>	1 unit	3.640	C	<b>3RG78 42-6JJ00</b>	1 unit	3.000
1200	Receiver	C	<b>3RG78 42-6EK01</b>	1 unit	4.570	C	<b>3RG78 42-6JK01</b>	1 unit	4.550
	Transmitter	C	<b>3RG78 42-6EK00</b>	1 unit	4.340	C	<b>3RG78 42-6JK00</b>	1 unit	4.330
1350	Receiver	C	<b>3RG78 42-6EL01</b>	1 unit	5.010	C	<b>3RG78 42-6JL01</b>	1 unit	5.000
	Transmitter	C	<b>3RG78 42-6EL00</b>	1 unit	4.810	C	<b>3RG78 42-6JL00</b>	1 unit	4.820
1500	Receiver	C	<b>3RG78 42-6EM01</b>	1 unit	5.280	C	<b>3RG78 42-6JM01</b>	1 unit	5.530
	Transmitter	C	<b>3RG78 42-6EM00</b>	1 unit	5.220	C	<b>3RG78 42-6JM00</b>	1 unit	5.270
1650	Receiver	C	<b>3RG78 42-6EN01</b>	1 unit	5.540	C	<b>3RG78 42-6JN01</b>	1 unit	5.470
	Transmitter	C	<b>3RG78 42-6EN00</b>	1 unit	5.540	C	<b>3RG78 42-6JN00</b>	1 unit	5.740
1800	Receiver	C	<b>3RG78 42-6EP01</b>	1 unit	6.350	C	<b>3RG78 42-6JP01</b>	1 unit	0.100
	Transmitter	C	<b>3RG78 42-6EP00</b>	1 unit	6.200	C	<b>3RG78 42-6JP00</b>	1 unit	0.100
2100	Receiver	C	<b>3RG78 42-6ER01</b>	1 unit	0.100	C	<b>3RG78 42-6JR01</b>	1 unit	7.450
	Transmitter	C	<b>3RG78 42-6ER00</b>	1 unit	0.100	C	<b>3RG78 42-6JR00</b>	1 unit	7.450
2400	Receiver	C	<b>3RG78 42-6ES01</b>	1 unit	9.500	C	<b>3RG78 42-6JS01</b>	1 unit	8.080
	Transmitter	C	<b>3RG78 42-6ES00</b>	1 unit	9.500	C	<b>3RG78 42-6JS00</b>	1 unit	8.080
2700	Receiver	C	<b>3RG78 42-6ET01</b>	1 unit	0.100	C	<b>3RG78 42-6JT01</b>	1 unit	0.100
	Transmitter	C	<b>3RG78 42-6ET00</b>	1 unit	0.100	C	<b>3RG78 42-6JT00</b>	1 unit	0.100
3000	Receiver	C	<b>3RG78 42-6EU01</b>	1 unit	0.100	C	<b>3RG78 42-6JU01</b>	1 unit	0.100
	Transmitter	C	<b>3RG78 42-6EU00</b>	1 unit	0.100	C	<b>3RG78 42-6JU00</b>	1 unit	0.100

Two standard mounting brackets are supplied with all 3RG78 42 devices (they can also be ordered as an accessory under the Order No. 3RG78 48-0AB).

# SIGUARD Light Curtains and Arrays With Separate Evaluation Unit

## Light curtains and arrays to Category 4

Light beams Number	Beam spacing mm	DT	Sensing range 18 m			Sensing range 60 m		
			Order No.	PS*	Weight per PU approx. kg	Order No.	PS*	Weight per PU approx. kg

### Light arrays



#### Type 4 according to IEC 61496-1,-2

2-beam	500	Receiver	A	<b>3RG78 42-6SE01</b>	1 unit	2.630	A	<b>3RG78 42-6SE51</b>	1 unit	2.620
		Transmitter	A	<b>3RG78 42-6SE00</b>	1 unit	2.420	A	<b>3RG78 42-6SE50</b>	1 unit	2.410
3-beam	400	Receiver	A	<b>3RG78 42-6PG01</b>	1 unit	3.480	A	<b>3RG78 42-6PG51</b>	1 unit	3.470
		Transmitter	A	<b>3RG78 42-6PG00</b>	1 unit	3.270	A	<b>3RG78 42-6PG50</b>	1 unit	3.270
4-beam	300	Receiver	A	<b>3RG78 42-6MH01</b>	1 unit	3.920	A	<b>3RG78 42-6MH51</b>	1 unit	3.910
		Transmitter	A	<b>3RG78 42-6MH00</b>	1 unit	3.690	A	<b>3RG78 42-6MH50</b>	1 unit	3.710

Two standard mounting brackets are supplied with all 3RG78 42 devices (they can also be ordered as an accessory under the Order No. 3RG78 48-0AB).

### Dimension drawings

#### 3RG78 42-6..0. standard light curtains, 3RG78 42-6 light array

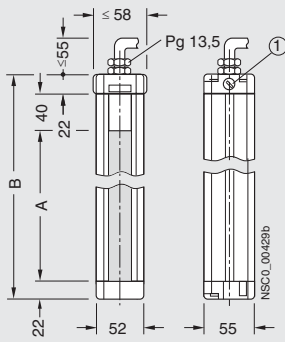

- ① Pg 9 sealing cap
- A Protective field height  
(see selection and ordering data)
- B Overall length = protective field A + 84 mm

#### 3RG78 42-6 light array

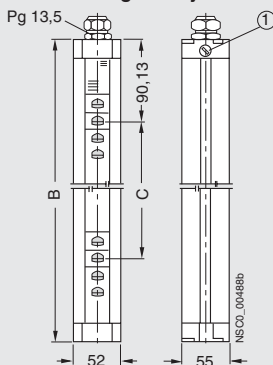

Additional dimensions for light array only:

Type	B	C	Beams
3RG78 42-6M	1134	300	4
3RG78 42-6P	984	400	3
3RG78 42-6S	684	500	2

# SIGUARD Light Curtains and Arrays

## With Separate Evaluation Unit

### Light curtains to Category 2

#### Technical specifications

<b>Type</b>	<b>3RG78 41</b>
<b>Safety category</b> acc. to EN, IEC 61496-1, -2	Type 2 (can be tested) in combination with an external monitoring device of Type 2
<b>Detection capability (resolution)</b>	30 mm, 55 mm, 80 mm
<b>Protective field height</b>	
• for 30 mm resolution	150 ... 1800 mm
• for 55 mm resolution	300 ... 1800 mm
• for 80 mm resolution	450 ... 3000 mm
<b>Protective field width, range</b>	0.3 ... 6 m
<b>Protection class</b>	I
<b>Supply voltage</b> (transmitter and receiver)	DC 24 V ± 20 % (external power section with safe isolation from the supply and 20 ms bridging of supply failures)
<b>Current consumption</b>	
• Transmitter	75 mA
• Receiver	75 mA (without external load)
<b>Synchronization</b> between transmitter and receiver	Optical; 2 selectable transmission channels
<b>Ambient temperature</b>	
• Operation	0 ... +55 °C
• Storage	-25 ... +75 °C
<b>Air humidity</b>	15 ... 95 % (no condensation)
<b>Degree of protection</b>	IP65
<b>Electrical connection</b>	M12 circular connector, 8-pole
<b>Connecting cable</b>	7-pole, 0.25 mm <sup>2</sup> (screened, with cast-on connector), 5 or 15 m long

#### Inputs

<b>Transmitter test input</b>	via floating NC contact or pnp output +24 V
• No test	
• Test	0 V or highly resistive
<b>Minimum signal duration</b> for triggering test	20 ms
<b>Test execution time</b>	10 ms

#### Outputs

<b>OSSD safety outputs</b>	pnp output, short-circuit proof
<b>Output current</b> $I_{a \max}$	100 mA
<b>Response time</b> from interruption of protective field until safety outputs switch off	Rises with number of beams (see operating instructions for precise values)
• for 30 mm resolution	8 ... 29 ms
• for 55 mm resolution	8 ... 19 ms
• for 80 mm resolution	8 ... 15 ms
<b>Reactivation time</b> from enabling the protective field until safety outputs switch on	
• For all resolutions	0.5 ms
• For extremely brief interruptions of the protective field	Min. 100 ms
<b>Pollution output and fault signaling output</b>	pnp output, short-circuit proof
<b>Output current, max.</b>	70 mA
<b>Diagnostics interface, receiver</b>	RS -485

#### Selection and ordering data

Protective field height	DT	30 mm resolution	PS*	Weight per PU approx.	DT	55 mm resolution	PS*	Weight per PU approx.
mm		Order No.		kg		Order No.		kg

#### Standard light curtains

##### Type 2 according to IEC 61496-1,-2

150	Receiver	A	<b>3RG78 41-3DB01</b>	1 unit	0.546	-		
	Transmitter	A	<b>3RG78 41-3DB00</b>	1 unit	0.369	-		
225	Receiver	A	<b>3RG78 41-3DC01</b>	1 unit	0.587	-		
	Transmitter	A	<b>3RG78 41-3DC00</b>	1 unit	0.406	-		
300	Receiver	A	<b>3RG78 41-3DD01</b>	1 unit	0.626	A	<b>3RG78 41-3FD01</b>	1 unit
	Transmitter	A	<b>3RG78 41-3DD00</b>	1 unit	0.451	A	<b>3RG78 41-3FD00</b>	1 unit
450	Receiver	A	<b>3RG78 41-3DE01</b>	1 unit	0.712	A	<b>3RG78 41-3FE01</b>	1 unit
	Transmitter	A	<b>3RG78 41-3DE00</b>	1 unit	0.527	A	<b>3RG78 41-3FE00</b>	1 unit
600	Receiver	A	<b>3RG78 41-3DF01</b>	1 unit	0.883	A	<b>3RG78 41-3FF01</b>	1 unit
	Transmitter	A	<b>3RG78 41-3DF00</b>	1 unit	0.697	A	<b>3RG78 41-3FF00</b>	1 unit
750	Receiver	A	<b>3RG78 41-3DG01</b>	1 unit	0.945	A	<b>3RG78 41-3FG01</b>	1 unit
	Transmitter	A	<b>3RG78 41-3DG00</b>	1 unit	0.793	A	<b>3RG78 41-3FG00</b>	1 unit
900	Receiver	A	<b>3RG78 41-3DH01</b>	1 unit	1.060	A	<b>3RG78 41-3FH01</b>	1 unit
	Transmitter	A	<b>3RG78 41-3DH00</b>	1 unit	0.883	A	<b>3RG78 41-3FH00</b>	1 unit
1050	Receiver	C	<b>3RG78 41-3DJ01</b>	1 unit	1.150	C	<b>3RG78 41-3FJ01</b>	1 unit
	Transmitter	C	<b>3RG78 41-3DJ00</b>	1 unit	0.981	C	<b>3RG78 41-3FJ00</b>	1 unit
1200	Receiver	C	<b>3RG78 41-3DK01</b>	1 unit	1.290	C	<b>3RG78 41-3FK01</b>	1 unit
	Transmitter	C	<b>3RG78 41-3DK00</b>	1 unit	1.290	C	<b>3RG78 41-3FK00</b>	1 unit
1350	Receiver	C	<b>3RG78 41-3DL01</b>	1 unit	1.400	C	<b>3RG78 41-3FL01</b>	1 unit
	Transmitter	C	<b>3RG78 41-3DL00</b>	1 unit	1.210	C	<b>3RG78 41-3FL00</b>	1 unit
1500	Receiver	C	<b>3RG78 41-3DM01</b>	1 unit	1.500	C	<b>3RG78 41-3FM01</b>	1 unit
	Transmitter	C	<b>3RG78 41-3DM00</b>	1 unit	1.500	C	<b>3RG78 41-3FM00</b>	1 unit
1650	Receiver	C	<b>3RG78 41-3DN01</b>	1 unit	1.640	C	<b>3RG78 41-3FN01</b>	1 unit
	Transmitter	C	<b>3RG78 41-3DN00</b>	1 unit	1.470	C	<b>3RG78 41-3FN00</b>	1 unit
1800	Receiver	C	<b>3RG78 41-3DP01</b>	1 unit	1.780	C	<b>3RG78 41-3FP01</b>	1 unit
	Transmitter	C	<b>3RG78 41-3DP00</b>	1 unit	1.610	C	<b>3RG78 41-3FP00</b>	1 unit

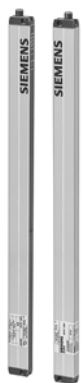

# SIGUARD Light Curtains and Arrays With Separate Evaluation Unit

## Light curtains to Category 2

Protective field height	DT	80 mm resolution	PS*	Weight per PU approx.
mm		Order No.		kg

### Standard light curtains

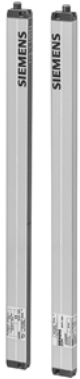

#### Type 2 according to IEC 61496-1,-2

450	Receiver	A	<b>3RG78 41-3HE01</b>	1 unit	0.635
	Transmitter	A	<b>3RG78 41-3HE00</b>	1 unit	0.526
600	Receiver	A	<b>3RG78 41-3HF01</b>	1 unit	0.841
	Transmitter	A	<b>3RG78 41-3HF00</b>	1 unit	0.660
900	Receiver	A	<b>3RG78 41-3HH01</b>	1 unit	1.050
	Transmitter	A	<b>3RG78 41-3HH00</b>	1 unit	0.867
1200	Receiver	C	<b>3RG78 41-3HK01</b>	1 unit	1.240
	Transmitter	C	<b>3RG78 41-3HK00</b>	1 unit	1.070
1500	Receiver	C	<b>3RG78 41-3HM01</b>	1 unit	1.500
	Transmitter	C	<b>3RG78 41-3HM00</b>	1 unit	1.310
1800	Receiver	C	<b>3RG78 41-3HP01</b>	1 unit	1.770
	Transmitter	C	<b>3RG78 41-3HP00</b>	1 unit	1.770

Length	Version	DT	Order No.	PS*	Weight per PU approx.
mm					kg

### Protection profile and mounting profile for 3RG78 41 light curtains



150		A	<b>3RG78 48-0GB</b>	1 unit	0.293
225		A	<b>3RG78 48-0GC</b>	1 unit	0.390
300		A	<b>3RG78 48-0GD</b>	1 unit	0.435
450		A	<b>3RG78 48-0GE</b>	1 unit	0.627
600		A	<b>3RG78 48-0GF</b>	1 unit	0.769
750		A	<b>3RG78 48-0GG</b>	1 unit	0.916
900		A	<b>3RG78 48-0GH</b>	1 unit	0.990
1050		C	<b>3RG78 48-0GJ</b>	1 unit	0.001
1200		C	<b>3RG78 48-0GK</b>	1 unit	1.340
1350		C	<b>3RG78 48-0GL</b>	1 unit	1.470
1500		C	<b>3RG78 48-0GM</b>	1 unit	1.630
1650		C	<b>3RG78 48-0GN</b>	1 unit	1.760
1800		C	<b>3RG78 48-0GP</b>	1 unit	1.930

### Connecting cable with M 12 connector for 3RG78 41 light curtains

5 m	straight	A	<b>3RG78 48-1BA</b>	1 unit	0.423
5 m	angled	A	<b>3RG78 48-1BC</b>	1 unit	0.425
15 m	straight	A	<b>3RG78 48-1BD</b>	1 unit	1.110
15 m	angled	A	<b>3RG78 48-1BE</b>	1 unit	1.110

### Dimension drawings

#### 3RG78 41-3..0. standard light curtains

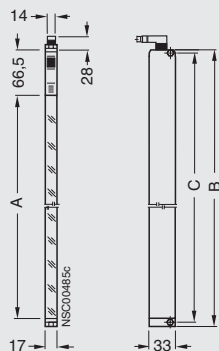

Type	A	B	C
3RG78 41-3.B..	170.5	248.5	238.5
3RG78 41-3.C..	245.5	323.5	313.5
3RG78 41-3.D..	320.5	398.5	388.5
3RG78 41-3.E..	470.5	548.5	538.5
3RG78 41-3.F..	620.5	698.5	688.5
3RG78 41-3.G..	770.5	848.5	838.5
3RG78 41-3.H..	920.5	998.5	988.5
3RG78 41-3.J..	1 070.5	1 148.5	1 138.5
3RG78 41-3.K..	1 220.5	1 298.5	1 288.5
3RG78 41-3.L..	1 370.5	1 448.5	1 438.5
3RG78 41-3.M..	1 520.5	1 598.5	1 588.5
3RG78 41-3.N..	1 670.5	1 748.5	1 738.5
3RG78 41-3.P..	1 820.5	1 898.5	1 888.5

# SIGUARD Light Curtains and Arrays

## With Separate Evaluation Unit

### Evaluation units

#### Technical specifications

##### 3RG78 47-4BB standard evaluation unit

<b>Safety category</b> acc. to EN 954-1	Category 4
<b>STOP category</b> to EN 60204-1 (11/98)	STOP category 0
<b>Supply voltage</b>	AC/DC 24 V, -15 % ... +10 %
<b>Residual ripple (for DC)</b>	2.4 V <sub>pp</sub>
<b>Frequency (for AC)</b>	50 ... 60 Hz
<b>Power consumption</b>	2.1 W (for AC)/1.7 W (for DC)
<b>External protection</b> for supply circuit	1 A slow
<b>Output contacts</b>	2 NO, 1 NC AgSnO <sub>2</sub> , gold plated
<b>Breaking capacity</b> acc. to EN 60947-5-1	
• AC-15, 230 V	6 A
• DC-13, 24 V (360 operating cycles/h)	6 A
• DC-13, 24 V (3600 operating cycles/h)	3 A
<b>Max. cont. current</b> per cond. path	6 A
<b>Contact protection</b> per cond. path	6.3 A quick or 4 A slow
<b>Max. total current</b> for all cond. paths	12 A
<b>Mechanical endurance</b>	10 × 10 <sup>6</sup> operating cycles
<b>Operating frequency</b>	3600 operating cycles
<b>Pick-up delay</b>	
• Manual start	70 ms
• Automatic start	230 ms
<b>Release delay, response time</b>	20 ms
<b>Minimum on-time S34, S35</b>	80 ms
<b>Solid-state backup</b>	
• Response time	2 s
• Recovery time	2 s
<b>Control voltage/current on S11, S22, S31</b>	DC 24 V/20 mA
<b>Permissible input lead resistance</b>	< 70 Ω
<b>Emitted interference</b>	EN 50081-1, -2
<b>Interference immunity</b>	EN 50082-2
<b>Clearance and creepage distances</b> to EN 60064	4 kV
<b>Operating temperature</b>	-25 ... +55 °C
<b>Degree of protection</b>	
• Enclosure	IP40
• Terminals	IP20
<b>Conductor cross-sections</b>	
• Finely stranded	2 × 0.14 ... 0.75 mm <sup>2</sup>
• Finely stranded with end sleeve	2 × 0.25 ... 0.5 mm <sup>2</sup>
• Finely stranded with twin end sleeve	2 × 1.5 mm <sup>2</sup>
• Solid	1 × 0.14 ... 2.5 mm <sup>2</sup>
• Finely stranded with end sleeve	2 × 0.25 ... 2.5 mm

##### 3RG78 47 intelligent evaluation units

<b>Protection</b> acc. to EN, IEC 61496-1	Type 4
<b>Safety category</b> acc. to EN 954-1	Category 4
<b>STOP category</b> acc. to EN 60204-1 (11/98)	STOP category 0
<b>Supply voltage</b>	DC 24 V, ± 20%, external power section with safe isolation from the supply and bridging of 20 ms voltage drop is necessary
<b>Current consumption</b>	Approx. 200 mA without external load
<b>External protection</b> (power supply)	2.5 A mT
<b>Safety sensors that can be connected</b> (expanded versions)	1 light curtain, Type 4, or up to 2 light curtains of Type 2 (all acc. to IEC 61496)  up to 2 light curtains of Type 4, or up to 4 light curtains of Type 2 (all acc. to IEC 61496)
Test outputs T1 and T2, test interval	200 ms
<b>Available functions</b>	
• All versions	Start/restart inhibit, contactor control, diagnosis Protection, single-pulse and two-pulse mode
• Versions with cycle control	Sequential muting, parallel muting, parallel double muting (only 3RG78 47-4.G)
• Versions with muting function	
<b>Control inputs</b>	
• Contactor control (EDM)	Feedback of positively-driven contacts of downstream contactors
• Start/restart inhibit (Reset)	Floating NO (button or key-switch)
<b>Conductor</b>	
• Muting sensors that cannot be tested	Signal level in damped state: active high, +24 V
• Muting sensors that can be tested	active high, +24 V, plus test pulses T1 or T2
<b>Outputs</b>	
• Muting displays for lamps 24 V, max. 5 W	pnp switching outputs muting function On, active high, +24 V, 200 mA max. Light curtain free/interrupted; switching state relay/transistor output; restart inhibit locked/unlocked; status of muting function; muting error; warning muting lamp defective; internal errors, etc.
• Signal outputs (acc. to variants)	
<b>Operating temperature</b>	0 ... +55 °C
<b>Degree of protection</b>	IP20; must be installed in switchgear cabinet or enclosure to IP 54 degree of protection upwards
<b>Installation</b>	Mounting on 35 mm standard mounting rail
<b>Connection</b>	Plug-in coded screw terminals up to 2.5 mm <sup>2</sup>





Outputs	Relay outputs	Semiconductor outputs
<b>OSSD safety outputs</b>	2 safety-related NO contacts	2 safety-related pnp semiconductor outputs with crossover detection
<b>Switching voltage/Switching current</b> • only for expanded variants	DC 60 V, AC 250 V, max. 6 A  1 safety-related NC contact, DC 60 V, AC 250 V, max. 6 A minimum switching current 20 mA	DC 24 V, max. 300 mA
<b>OSSD external protection</b>	6 A T	–
<b>OSSD response time</b> of evaluation unit (without light curtain) • for light curtain, Type 4, with semiconductor output • for light curtain, Type 2 • for safety switches	18 ms 54 ms 54 ms	8 ms 44 ms 44 ms
<b>OSSD reactivation time</b>	100 ms	100 ms
<b>OSSD suitable spark quenching</b> via the coils of the downstream relay	necessary	–



# SIGUARD Light Curtains and Arrays With Separate Evaluation Unit

Evaluation units

## Selection and ordering data

Version	DT	Relay output	PS*	Weight per PU approx.	DT	Semiconductor output	PS*	Weight per PU approx.
		Order No.		kg		Order No.		kg
<b>Evaluation units</b>								
<b>Category 2 acc. to EN 954-1</b>								
	A	<b>3RG78 25-1CB1</b>	1 unit	0.237	-			
<b>Category 4 acc. to EN 954-1<sup>1)</sup></b>								
	A	<b>3RG78 47-4BB</b>	1 unit	0.237	-			
3RG78 47-4BB								
	A	<b>3RG78 47-4BD</b>	1 unit	0.332	A	<b>3RG78 47-4DD</b>	1 unit	0.290
3RG78 47-4BE	A	<b>3RG78 47-4BE</b>	1 unit	0.393	A	<b>3RG78 47-4DE</b>	1 unit	0.331
	A	<b>3RG78 47-4BF</b>	1 unit	0.450	A	<b>3RG78 47-4DF</b>	1 unit	0.405
3RG78 47-4BF	A	<b>3RG78 47-4BG</b>	1 unit	0.527	C	<b>3RG78 47-4DG</b>	1 unit	0.468
	A	<b>3RG78 47-4BH</b>	1 unit	0.350	C	<b>3RG78 47-4DH</b>	1 unit	0.319
3RG78 47-4BJ	A	<b>3RG78 47-4BJ</b>	1 unit	0.413	C	<b>3RG78 47-4DJ</b>	1 unit	0.357
	A	<b>3RG78 47-4BK</b>	1 unit	0.445	A	<b>3RG78 47-4DK</b>	1 unit	0.410
3RG78 47-4BL	A	<b>3RG78 47-4BL</b>	1 unit	0.515	C	<b>3RG78 47-4DL</b>	1 unit	0.461

1) For light curtains and light arrays of Category 4, 3TK28 41 solid-state safety combinations can also be used.

2) Up to 2 light curtains of Type 4 as well as additional safety switches (e.g. EMERGENCY-STOP) can be connected to the expanded version.

Version	DT	Order No.	PS*	Weight per PU approx.
				kg
<b>Diagnostic software for evaluation units</b>				
	A	<b>3RG78 48-4AC</b>	1 unit	0.195
Diagnostics software for evaluation units, with PC cable				

\* This quantity or a multiple thereof can be ordered

Siemens LV 10 · 2004

11/113





# SIGUARD Light Curtains and Arrays With Separate Evaluation Unit

Evaluation units

## 3RG78 47-4BF evaluation units with integrated muting function

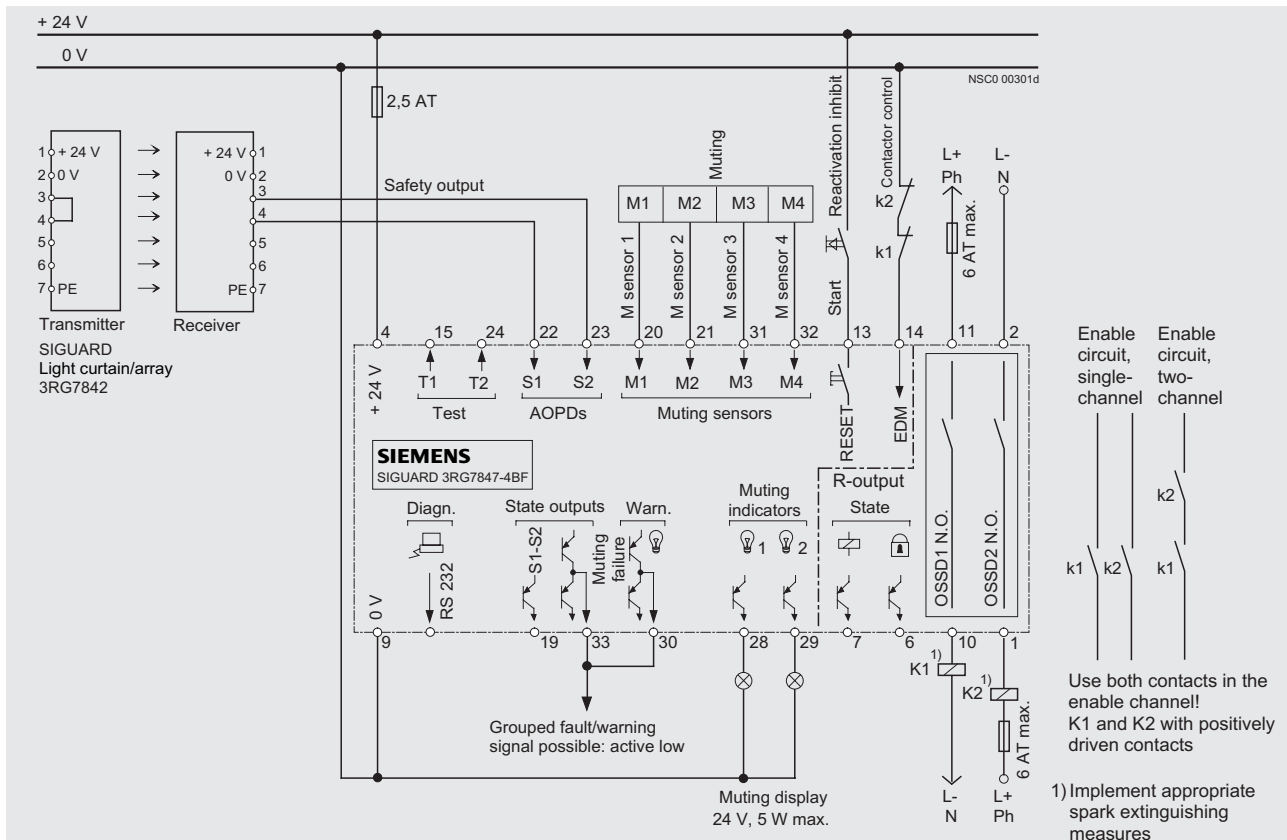

## 3RG78 47-4BH evaluation unit with cycle control

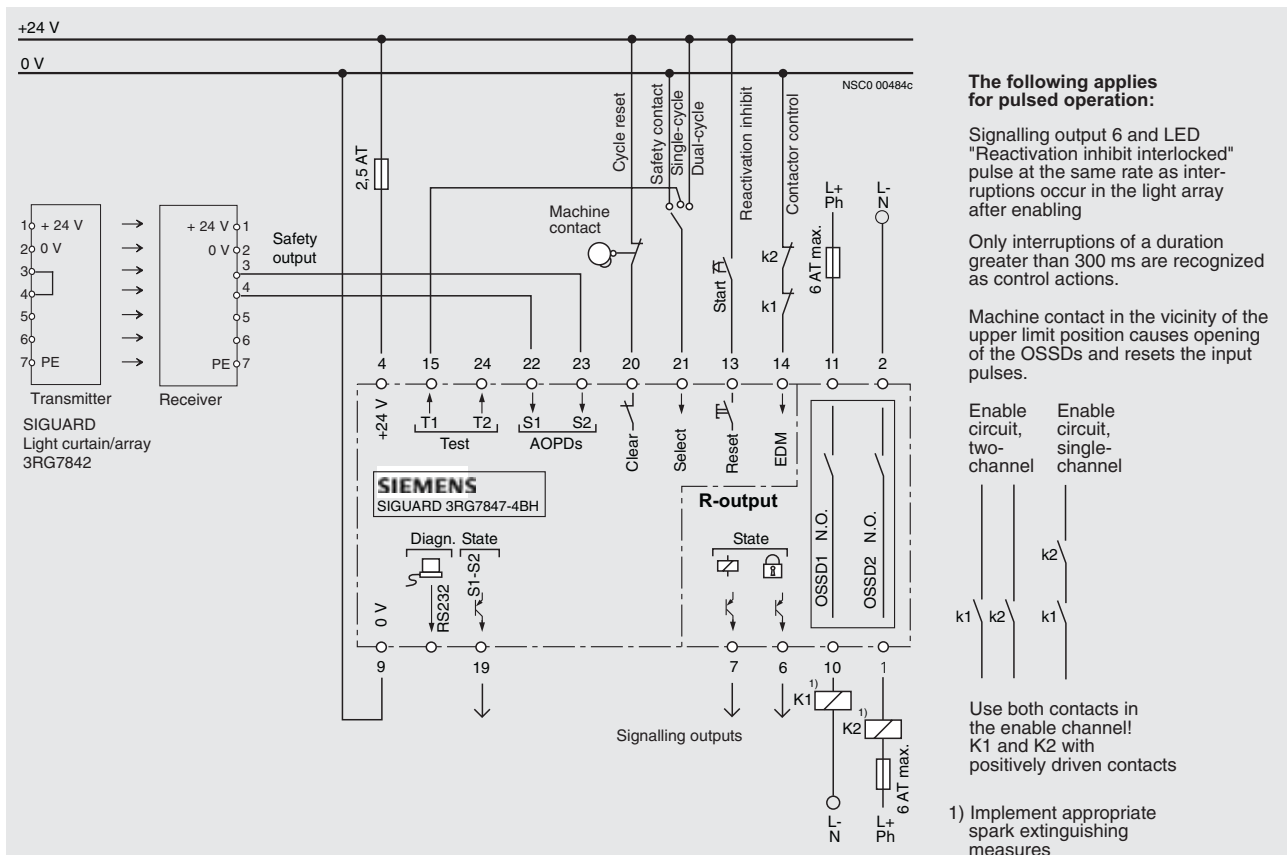

# SIGUARD Light Curtains and Arrays With Separate Evaluation Unit

## Evaluation units

### Dimension drawings

3RG78 47-4BB

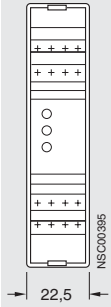

3RG78 47-4.D/E/H/J

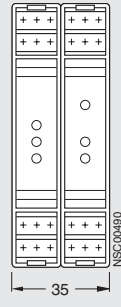

3RG78 47-4.F/G/K/L

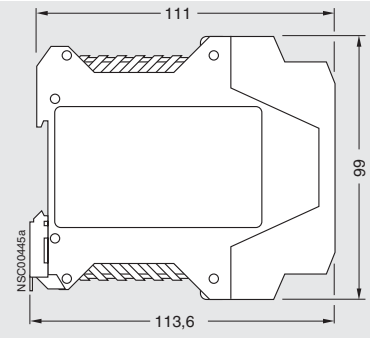
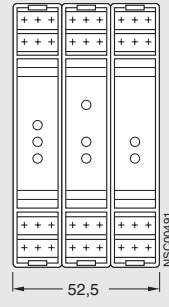

# SIGUARD Light Curtains and Arrays

## Accessories







### Mounting parts and other accessories

#### Overview

Installation, calibration, start-up and fault localization are aided by a wide range of practical accessories which include fixing columns, reflective mirror columns, reflective mirrors, brackets and laser alignment aids.

Furthermore, the function of the light curtain as well as that of the evaluation units can be visualized and recorded using PC software.

#### Selection and ordering data

	Length	DT	Order No.	PS*	Weight per PU approx.			
	mm				kg			
<b>Fixing columns</b>								
	1060	A	<b>3RG78 48-0CL</b>	1 unit	8.220			
	1360	A	<b>3RG78 48-0CP</b>	1 unit	9.210			
	1660	C	<b>3RG78 48-0CR</b>	1 unit	10.900			
	1960	C	<b>3RG78 48-0CU</b>	1 unit	12.000			
<b>Reflective mirrors for light curtains</b>								
	<b>Reflective mirrors</b>							
	345	C	<b>3RG78 48-1DL</b>	1 unit	1.300			
	495	C	<b>3RG78 48-1DM</b>	1 unit	1.300			
	645	C	<b>3RG78 48-1DN</b>	1 unit	1.300			
	795	C	<b>3RG78 48-1DP</b>	1 unit	1.300			
	945	C	<b>3RG78 48-1DR</b>	1 unit	1.300			
1095	C	<b>3RG78 48-1DU</b>	1 unit	1.300				
	<b>Reflective mirrors</b>							
	410	A	<b>3RG78 48-0ED</b>	1 unit	1.980			
	510	A	<b>3RG78 48-0EE</b>	1 unit	2.350			
	625	A	<b>3RG78 48-0EF</b>	1 unit	2.840			
	740	A	<b>3RG78 48-0EG</b>	1 unit	3.250			
	830	A	<b>3RG78 48-0EH</b>	1 unit	3.590			
	930	A	<b>3RG78 48-0EJ</b>	1 unit	3.940			
	1030	C	<b>3RG78 48-0EK</b>	1 unit	4.340			
	1125	C	<b>3RG78 48-0EL</b>	1 unit	4.670			
	1220	C	<b>3RG78 48-0EM</b>	1 unit	5.000			
	1365	C	<b>3RG78 48-0EN</b>	1 unit	5.610			
	1510	C	<b>3RG78 48-0EP</b>	1 unit	6.190			
	1650	C	<b>3RG78 48-0EQ</b>	1 unit	6.780			
1830	C	<b>3RG78 48-0ER</b>	1 unit	0.100				
	<b>Reflective mirror columns</b>							
	1060	A	<b>3RG78 48-0DL</b>	1 unit	9.220			
	1360	A	<b>3RG78 48-0DP</b>	1 unit	10.600			
	1660	C	<b>3RG78 48-0DR</b>	1 unit	12.500			
1960	C	<b>3RG78 48-0DU</b>	1 unit	14.500				
<b>Reflective mirror columns for light arrays</b>								
	<b>Adjustable separate mirrors</b>							
	1060, 2-beam	A	<b>3RG78 48-0FL</b>	1 unit	8.590			
	1360, 3-beam	A	<b>3RG78 48-0FP</b>	1 unit	9.980			
	1360, 4-beam	A	<b>3RG78 48-0FR</b>	1 unit	10.100			
1060, 2-beam, for transceiver	A	<b>3RG78 48-0TL</b>	1 unit	1.500				
<b>Installation parts</b>								
	<b>Bracket, hinged with vibration damping</b> (including 2 screws and 2 keyway slides)							
	A	<b>3RG78 48-0BB</b>	1 unit	0.146				
	<b>Standard holding bracket set</b> (1 set = 2 units incl. screws)							
	A	<b>3RG78 48-0AB</b>	1 unit	0.268				
<b>Keyway blocks</b> (1 set = 2 units)					A	<b>3RG78 48-0AC</b>	1 unit	0.016
<b>End cap</b> for transmitter					A	<b>3RG78 48-1DA</b>	1 unit	0.103
<b>End cap</b> for receiver					A	<b>3RG78 48-1DB</b>	1 unit	0.103

\* This quantity or a multiple thereof can be ordered

# SIGUARD Light Curtains and Arrays

## Accessories

### Mounting parts and other accessories

Version	DT	Order No.	PS*	Weight per PU approx. kg
<b>Cables and cable plugs</b>				
<b>Cable plug</b> , Type Hirschmann, 12-pole	C	<b>3RG78 48-2DA</b>	1 unit	0.100
<b>Angular cable socket</b> , Type Hirschmann, 12-pole	C	<b>3RG78 48-2DB</b>	1 unit	0.100
<b>Cable</b> for local connection, 3 m, with angular M12 plug	C	<b>3RG78 48-2AK</b>	1 unit	0.300
<b>Cable</b> for local connection, 10 m, with angular M12 plug	A	<b>3RG78 48-2BK</b>	1 unit	1.000
<b>Keys</b>				
 <b>Safety key</b> for Teach-in	C	<b>3RG78 48-2AH</b>	1 unit	0.100
 <b>Magnet key</b> for alignment indicator	C	<b>3RG78 48-2BH</b>	1 unit	0.100
<b>Laser alignment aids</b>				
 Standard version <sup>1)</sup> For installation with fixing columns	A	<b>3RG78 48-1AB</b>	1 unit	0.357
	A	<b>3RG78 48-1AG</b>	1 unit	0.368
<b>Test rods</b>				
for 3RG78 41 and 3RG78 42, 14 mm and 30 mm resolution	A	<b>3RG78 48-0AH</b>	1 unit	0.047
Set for 3RG78 44 light curtains	A	<b>3RG78 48-0FH</b>	1 unit	0.261
<b>Diagnostics software</b>				
 for light curtains and light arrays	A	<b>3RG78 48-1AC</b>	1 unit	0.240
<b>RS485/232 converters</b>				
 for diagnostics interface	A	<b>3RG78 48-1AD</b>	1 unit	0.089
<b>Cables for diagnostics</b>				
 <b>RS232 connecting cable</b>	A	<b>3RG78 48-1AE</b>	1 unit	0.134
 <b>Diagnostics cable kit</b>	A	<b>3RG78 48-1AF</b>	1 unit	0.569
	A	<b>3RG78 48-1AL</b>	1 unit	0.348
	A	<b>3RG78 48-1AM</b>	1 unit	0.494

1) Only for use with light curtain Type 4.

# SIGUARD Light Curtains and Arrays

## Accessories

### Mounting parts and other accessories

#### Dimension drawings

**3RG78 48-0C.**  
fixing column

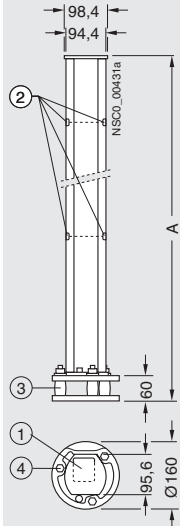

**3RG78 48-0D., 3RG78 48-0F.**  
reflective mirror column

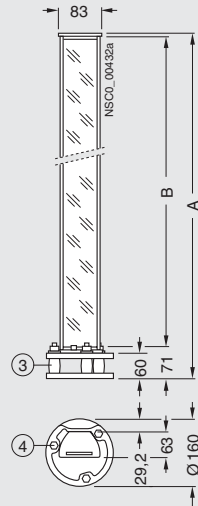

**3RG78 48-0E.**  
reflective mirror

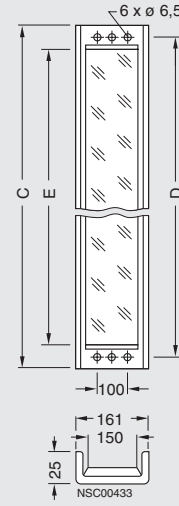

Type	C	D	E
3RG78 48-0ED	480	460	410
3RG78 48-0EE	580	560	510
3RG78 48-0EF	695	675	625
3RG78 48-0EG	810	790	740
3RG78 48-0EH	900	880	830
3RG78 48-0EJ	1000	980	930
3RG78 48-0EK	1100	1080	1030
3RG78 48-0EL	1195	1175	1125
3RG78 48-0EM	1290	1270	1220
3RG78 48-0EN	1435	1415	1365
3RG78 48-0EP	1580	1560	1510
3RG78 48-0EQ	1720	1700	1650
3RG78 48-0ER	1900	1880	1830

Type	A	B
3RG78 48-0.L	1060	974
3RG78 48-0.P	1360	1274
3RG78 48-0.R	1660	1574
3RG78 48-0.U	1960	1874

- ① Light curtain
- ② 8 drilled holes,  $\varnothing$  16 mm
- ③ Plastic spring element with return action
- ④ 3 drilled holes in floor for wall plugs,  $\varnothing$  10 mm, 80 mm deep

**3RG78 48-0AB standard mounting bracket**  
(included in scope of supply)

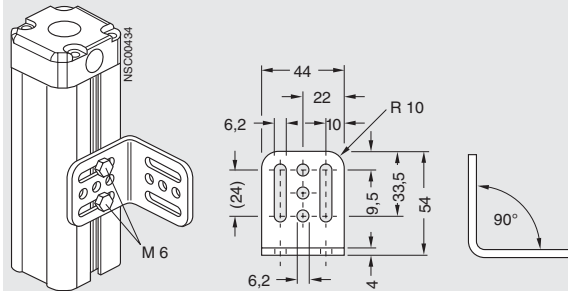

**3RG78 48-0BB bracket,**  
swivel-type with vibration damping

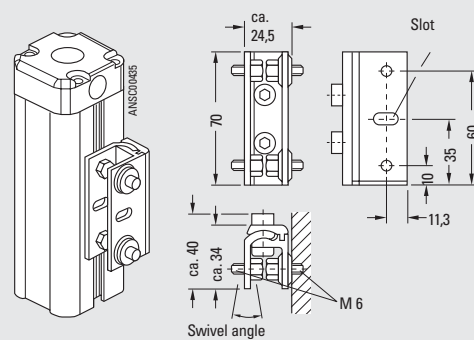

# SIGUARD Laser Scanners

## Standard LS4 laser scanners

### Overview



The SIGUARD LS4 laser scanner is an optical distance sensor. The device transmits light pulses at intervals within an operating range of 190°. If the pulses hit an obstruction or a person, the light is reflected and received and evaluated by the laser scanner.

The scanner calculates the precise coordinates of the obstruction "seen" from the light propagation time. If the obstruction or the person is located within defined ranges, a Stop function is executed. Persons can be detected in a failsafe manner by the laser scanner up to a distance of 4.0 m even if they are wearing very dark clothing. Objects can be detected up to a distance of 15 m under conditions without relevance to safety.

Up to four programmable protective field pairs which can be selected during operation allow the protective field to be optimized for the application.

The laser scanner is available in three versions which allows it to be optimally integrated into various systems. The standard scanner features failsafe, self-monitoring semiconductor outputs for conventional integration into the safety circuit.

The variants with communications capability for PROFIBUS with the PROFIsafe profile as well as AS-Interface *Safety at Work* support direct connection as a failsafe station to the respective bus system.

Further information is available on the Internet at: [www.siemens.de/laserscanner](http://www.siemens.de/laserscanner).

### Area of application

#### Horizontal danger zone protection

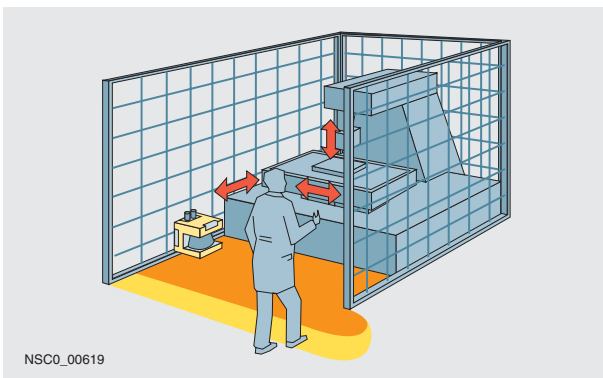

- Reliable detection of persons and objects in danger zones of machines and plants,
- Flexible programming of almost any type of protection and warning zones.

#### Horizontal danger zone protection with several protective fields

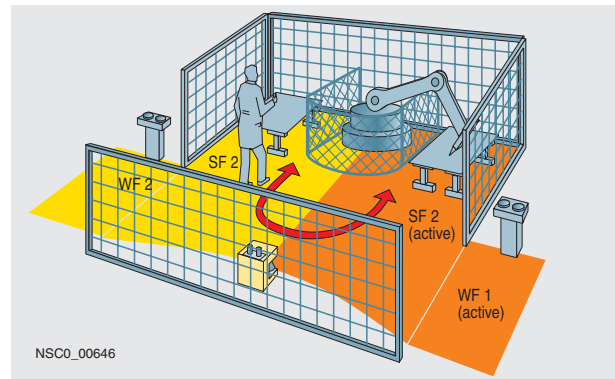

- Reliable detection of persons in different danger zones by switching between protective fields,
- Enhanced availability due to accurate protection of only the currently active fields.

#### Route monitoring for automatic guided vehicle systems

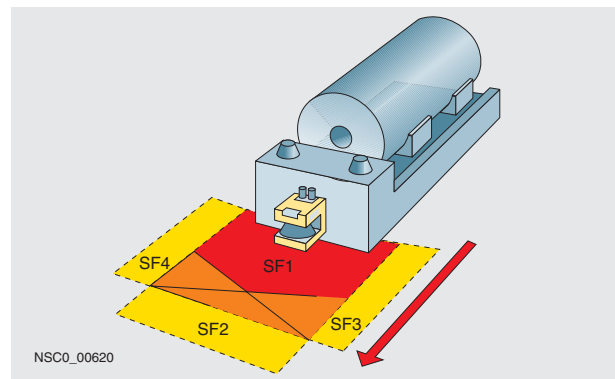

- Reliable detection of persons and objects that approach the vehicle,
- The laser scanner offers a greater protection range than bumpers and therefore permits higher speeds.

#### Collision protection for shifting units

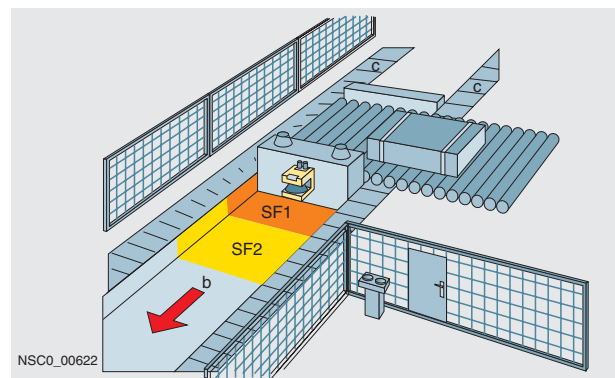

- Reliable protection of persons who are in the path of the vehicle,
- Objects in the path of the vehicle are detected early and damage to the vehicle or load is prevented.

## Standard LS4 laser scanners

### Functions

The SIGUARD LS4 laser scanner is an optical, non-contact area scanner – it is designed principally for personnel safety.

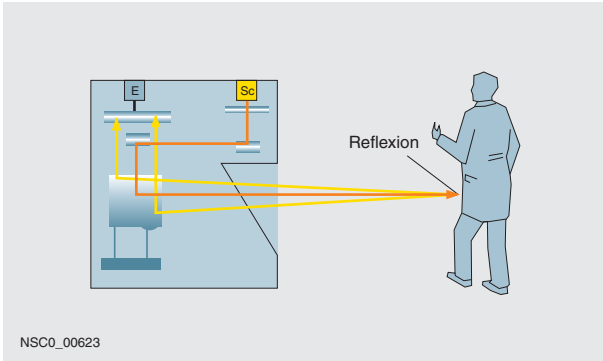

The laser scanner continuously creates bundled light pulses by means of a laser diode which are then spread throughout the operating range by an integrated rotating mirror. If objects or persons enter the field, it evaluates the reflected light pulses and calculates the precise position coordinates continuously on the basis of the light propagation time. If the defined personnel protective field is penetrated, the laser scanner stops the machine immediately (within the system response time). The Stop function is reset when the protective field is free again, depending on the operating mode, either automatically or following acknowledgement.

The operating range of the SIGUARD LS4 laser scanner spans 190° and is subdivided into angle segments of 0.36°.

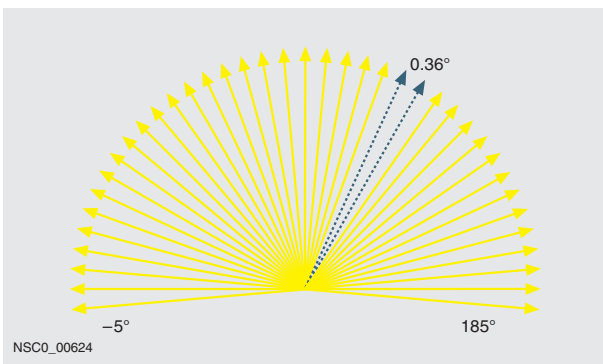

The scan rate is 25 scans per second which means one light pulse every 40 ms in each segment. A special algorithm ensures that objects starting from a size of 70 mm – which corresponds to the resolution of the scanner – can be reliably detected, but disturbances such as dust do not diminish the availability of the system. The LS4 laser scanner detects persons – even when wearing very dark clothing – failsafe up to distances of 4 meters. In addition, persons and objects can be detected (non-safety-related) up to a distance of 15 meters, for example, to output a warning signal.

### Four protection and warning field pairs

The LS4 laser scanner can easily be adapted to any requirement with four variable protective field pairs – easily set using the PC – for the personnel protective field and the warning field.

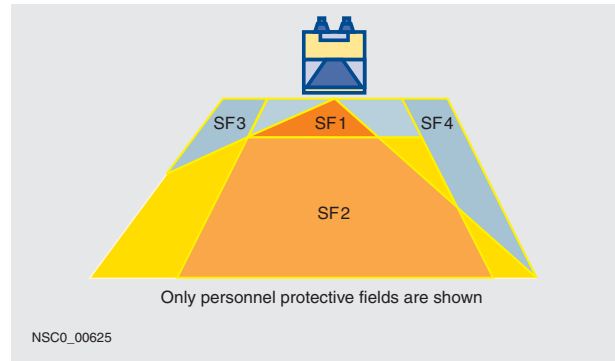

It can be applied stationary on machines and installations, but also mobile on vehicles, automatic guided vehicle systems or shifting units. In the case of a robot, for example, different operating ranges can be protected in which the laser scanner operates one after the other regarding time and space. In the case of automatic guided vehicle systems, four programmable protective fields can be used, for example, for the protection of rapid travel, slow travel, turning to the left and turning to the right.

### LS4Soft operating software

Thanks to the PC operating software LS4soft, precise setting of the laser scanner is almost child's play. The following functions have been integrated:

- User-friendly configuration of the protective field using a PC or laptop
- Configuration of additional functions such as protective field selection, restart inhibit, etc. with the help of a software wizard
- Comprehensive indication of, for example, defined protective fields, current scan contours, system settings, etc.; reliable access protection through passwords with different authorization levels
- Executable under Microsoft Windows 95/98/NT/2000.

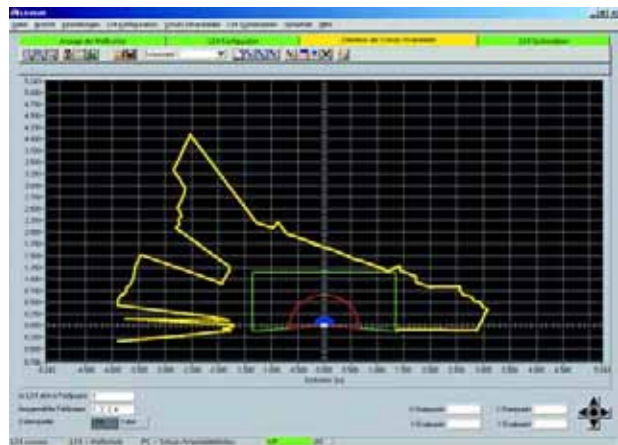



# SIGUARD Laser Scanners

## Standard LS4 laser scanners

### Technical specifications

#### Protective field data

Type	3RG78 34
<b>Personnel protective field</b>	
Detection range	0 ... 4 m
Luminance factor	min. 1.8 %
Object size and diameter	70 mm (cylindrical test body)
Measuring error	
• For protective field size < 3.5 mm	max. 81 mm
• For protective field size > 3.5 mm	max. 98 mm
Response time	
• Dual evaluation (2 scans)	80 ms
• Adjustable up to 16 scans	640 ms
Number of protective fields	4 (selectable via switching inputs)
Output	2 failsafe pnp transistor outputs, 24 V, 250mA
Safety category	
• acc. to DIN V 19250	Class 4
• acc. to EN 954-1	Category 3, single-fault protection
• acc. to IEC 61496-1, EN 61496-3	Type 3
Start	The start test and start inhibit can be set up separately
Restart	Adjustable 160 ms ... 10 s or manually
Supplement for deactivated dust suppression	81 mm
Supplement for activated dust suppression	
• for protective field size < 3.5 m	81 mm
• for protective field size > 3.5 m	98 mm
Additional supplement in the case of retro-reflectors or highly reflective surfaces (such as certain metals or ceramics) in the scan plane	
• Over 1.2 m behind the protective field line	0 mm
• In the protective field or up to 1.2 m behind the protective field line	110 mm
<b>Warning field</b>	
Detection range	0 ... 15 m
Luminance factor	min. 20 %
Object size	150 mm × 150 mm
Response time	
• Dual evaluation (2 scans)	80 ms
• Adjustable up to 16 scans	640 ms
Number of warning fields	4 (selectable via switching inputs)
Output	pnp transistor output, max. 100 mA
<b>Contour measurement</b>	
Detection range	0 ... 50 m
Luminance factor	min. 20 %
Object size	–
Output	Serial interface RS232 (10 m), RS 422 (50 m)
Radial resolution	5 mm
Lateral resolution	0.36°

#### Electrical data, software

Type	3RG78 34
<b>Power supply</b>	
Operating voltage	Supply according to IEC 60742 with safety isolating transformer or similar in the case of DC/DC converters
• External supply	DC 24 V –30 ... +20 %
Current consumption	Approx. 300 mA, use power section with 2.5 A
Power consumption at 24 V	8 W plus output load
Overcurrent protection	Using 1.25 A medium-slow fuse in switchgear cabinet
Overvoltage protection	with final shutdown backup
Voltage drops	Acc. to EN 61496-1
Protective conductor	Connection not permitted
<b>Inputs</b>	
Restart/Reset	Connection of a command unit for operating mode with restart inhibit and/or device reset, dynamically monitored, DC 24 V optically decoupled
Field pair changeover	Selection from 4 field pairs via 4 control leads with internal monitoring (1 field pair = 1 protective field and 1 warning field), DC 24 V optically decoupled
Signal definition	
• High (logical 1)	16 ... 30 V
• Low (logical 0)	< 3 V
<b>Parameterization</b>	
Operating software	Communications and parameterization software under Windows 95/98/NT/2000 with safe protocol for programming
<b>Interfaces</b>	
For device parameterization and field definition	RS 232, RS 422
<b>Outputs</b>	
Protective field	2 × safe semiconductor output, pnp, max. 250 mA short-circuit monitored, overcurrent protected
Warning field, pollution, fault	pnp transistor output, max. 100 mA
Load characteristics, maximum values	Low-pass response
• Limit frequency $f_g$	< 1 kHz
• Capacitance $C_{load}$	< 100 nF
Level	
• High (OSSD)	$U_b - 3.2 V$
• Low (OSSD)	< 2 V
• High (alarm active)	$U_b - 4 V$
• Low (alarm inactive)	< 2 V





## Standard LS4 laser scanners

### Mechanical, optical data

<b>Type</b>	<b>3RG78 34</b>
<b>Environment and materials</b>	
Degree of protection to IEC 60529	IP65
Shock-hazard protection	Total insulation, Safety Class 2
Ambient temperature	
• Operation	0 ... +50 °C
• Storage	-20 ... +60 °C
Humidity acc. to DIN 40040	Table 10, code letter E (fairly dry)
Enclosure material	Cast aluminum, plastic
Weight	approx. 3 kg
Dimensions (W x H x D)	140 mm x 155 mm x 135 mm
Distance from center of scan plane to lower edge of enclosure	48.75 mm
Distance from rear edge of enclosure to rotating mirror axis	68 mm
Vibratory load over 3 axes acc. to IEC 60068, Part 2-6	10 ... 150 Hz, max. 5 g
Continuous shock over 3 axes acc. to IEC 60068, Part 2-29	10 g, 16 ms
Interference immunity	
• Acc. to EN 61496-1	Acc. to the requirements for Type 4
• Also acc. to DIN 40839-1, -3	Test pulses 1, 2, 3a, 3b, 5 (not for use in vehicles with internal combustion engines)
Rotating mirror drive	Brushless DC motor
Rotating mirror bearing	Maintenance-free ball bearing

<b>Type</b>	<b>3RG78 34</b>
<b>Connections</b>	
Cable lengths	
• Control cable X1	max. 50 m for conductor cross-section of 0.5 mm <sup>2</sup> , shielded
• Data cable X2, RS 232	Max. 10 m
• Data cable X2, RS 422	Max. 50 m (Twisted Pair)
• Control cable X3	–
<b>Optical characteristics</b>	
Rotation angle	max. 190°
Angle resolution	0.36°
Lateral tolerance	
• Without assembly system (for rear of enclosure)	± 0.18°
• With assembly system (for mounting surface)	± 0.22°
Scan rate	25 scans/s or 40 ms/scan
Laser protection class acc. to EN 60825-1	Class 1 (safe for eyes)
• Wave length	905 nm (infra-red)
• Beam divergence	2 mrad
• Time base	100 s

### Selection and ordering data

Version	DT	Order No.	PS*	Weight per PU approx. kg
<b>Laser scanner</b>				
	A	<b>3RG78 34-6DD00</b>	1 unit	3.060
<b>LS4 standard laser scanner</b> incl. LS4soft software				
	A	<b>3SF78 34-6DD00</b>	1 unit	3.060
<b>LS4 AS-Interface laser scanner</b> incl. LS4soft software				
	A	<b>3SF78 34-6PB00</b>	1 unit	3.060
<b>PROFIBUS DP LS4 laser scanner</b> incl. LS4soft software				

For suitable evaluation units for standard laser scanners, see Page 11/112.

\* This quantity or a multiple thereof can be ordered

# SIGUARD Laser Scanners

## Standard LS4 laser scanners

Version	Length	DT	Order No.	PS*	Weight per PU approx.
	m				kg

### Accessories

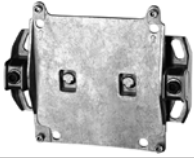

<b>Mounting system</b> , hinged, for easy alignment	A	<b>3RG78 38-1AA</b>	1 unit	0.690
<b>Adapter plate</b>	A	<b>3RG78 38-1AB</b>	1 unit	0.811
<b>Spare window</b> (incl. seal)	A	<b>3RG78 38-7AA</b>	1 unit	0.123

### Cables and connectors

<b>Connecting cable</b> incl. connector, 15-pole (X1)	5	A	<b>3RG78 38-1BD</b>	1 unit	0.723
	10	A	<b>3RG78 38-1BE</b>	1 unit	1.370
	20	A	<b>3RG78 38-1BF</b>	1 unit	2.760
	35	A	<b>3RG78 38-1BG</b>	1 unit	4.610
	50	A	<b>3RG78 38-1BH</b>	1 unit	6.500
<b>Connector, complete</b> , 15-pole (X1)		A	<b>3RG78 38-1BA</b>	1 unit	0.038
<b>PC connecting cable</b> incl. connector, 9-pole (X2)	3	A	<b>3RG78 38-1CC</b>	1 unit	0.164
	5	A	<b>3RG78 38-1CD</b>	1 unit	0.236
	10	A	<b>3RG78 38-1CE</b>	1 unit	0.404
<b>Connector, complete</b> , 9-pin (X2)		A	<b>3RG78 38-1CA</b>	1 unit	0.032
<b>PC connecting cable for AS-Interface and PROFIBUS DP</b> incl. connector, 9-pole (X2) and optical interface		A	<b>3RG78 38-1DC</b>	1 unit	0.164

### Dimension drawings

Laser scanner with switching outputs, 3RG78 34-6DD00

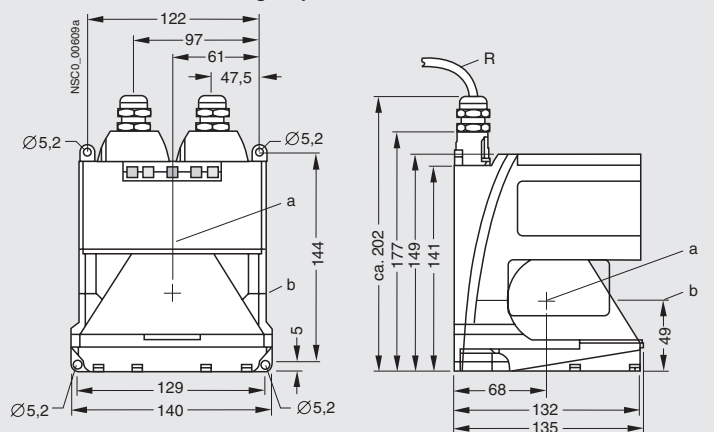

R = smallest bending radius 50 mm (for original accessories)  
a = rotating mirror axis  
b = scan plane

3RG78 38-1AA mounting system

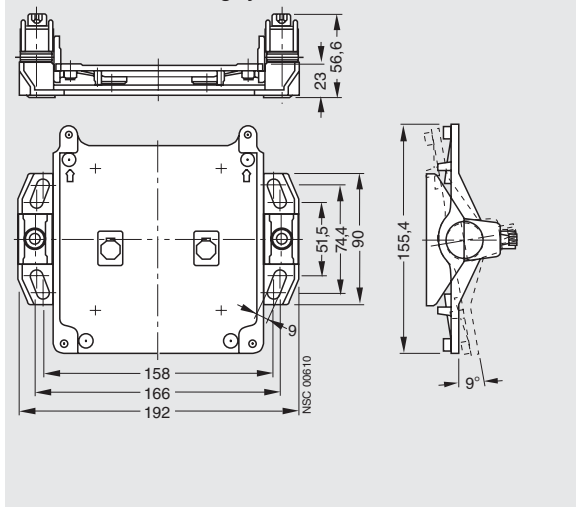

3SF78 34-6DD00 AS-Interface laser scanner,  
3SF78 34-6BP00 PROFIBUS DP laser scanner

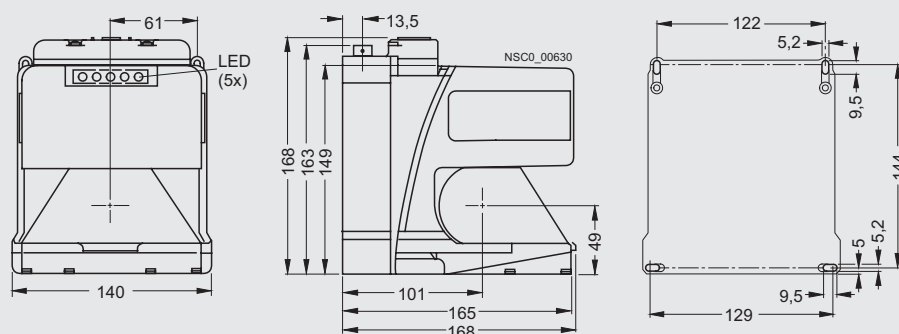

# SIGUARD Light Barriers

Light barriers, Category 2 with evaluation unit,  
Light barriers, Category 4

## Overview

The SIGUARD light barriers are non-contact protective devices for access protection for hazardous areas, hazardous locations and entry points. They are the optimum solution in many cases especially when security is necessary but must not have a disruptive effect or reduce productivity.

Whenever a light beam is interrupted, a signal is output for reliable interruption of a dangerous movement of a machine, installation or other motorized equipment.

A complete system comprises at least one thru-beam sensor with separate transmitter and receiver. Two different systems are available which are authorized as a complete unit for Safety Category 2 or 4 in accordance with EN 954-1 by a German trade association.

- Category 2 with a separate evaluation unit,
- Category 4, operation without an evaluation unit is possible.

The 3RG78 23 light barriers (Category 2) only operate as non-contact safety devices in conjunction with the 3RG78 25 or 3RG78 47 evaluation units. The 3RG78 24 light barriers (Category 4) can also be operated with the 3RG78 47 evaluation units.

For details of 3RG78 47 evaluation units, see the section "Light curtains".

## Area of application

Typical applications for light barriers include access protection for:

- Power-operated windows, doors and gates
- Warehouse equipment and devices
- Packaging machines
- Palette loading systems
- Stacking systems
- Winding and unwinding machines
- Textile machines
- Food machines
- Printing and paper processing machines
- Processing machines in the chemicals, plastics and rubber industries
- Recirculating buffers
- Lifting platforms
- Butcher's machines
- and many more applications.

## Technical specifications

### Light barriers

Type	3RG78 23	3RG78 24
<b>Category acc. to EN 954-1</b>	<b>Category 2</b>	<b>Category 4</b>
Operating voltage	DC 24 V	DC 24 V
Operating range	0 ... 120 m	0 ... 60 m
Typical range limit <sup>1)</sup>	0 ... 150 m	–
Light type	Infrared (880 nm)	
Opening angle	Max. 4°	Max. 2°
Object size	min. 9 mm Ø	min. 13 mm Ø
Operating temperature	–25 ... +60 °C	
Degree of protection	IP65	
Conductor	M 12 circular connector	Pg cable gland

### Evaluation units

Type	3RG78 25	–
<b>Category acc. to EN 954-1</b>	<b>Category 2</b>	
Operating voltage	DC 24 V, ± 15 %	
Response time	max. 20 ms	
Current consumption	approx. 200 mA	
Safety output	2 floating NO contacts	
Current-carrying capacity	max. 4 A	
Signaling outputs	Separate pnp transistor outputs	
Operating temperature	–20 ... +60 °C	
Degree of protection <sup>2)</sup>	IP40	

1) The range limit is the maximum achievable range without surplus light emission.

2) Only suitable for use in electrical equipment areas, e.g. control cabinet to the IP54 degree of protection.

# SIGUARD Light Barriers

Light barriers, Category 2 with evaluation unit,  
Light barriers, Category 4

## Selection and ordering data

Version	Conductor	DT	Order No.	PS*	Weight per PU approx. kg
<b>Safety light barriers</b>					
<b>Category 2 acc. to EN 954-1</b>					
Transmitter	M12 circular connector	X	<b>3RG78 23-3BG00</b>	1 unit	0.463
Receiver, range 0 ... 150 m	M12 circular connector	X	<b>3RG78 23-3KB00</b>	1 unit	0.463
<b>Category 4 acc. to EN 954-1</b>					
Transmitter	Pg 11 cable gland	X	<b>3RG78 24-6BG00</b>	1 unit	0.580
Receiver, range 0 ... 60 m	Pg 11 cable gland	X	<b>3RG78 24-6JB00</b>	1 unit	0.600
<b>Evaluation unit</b>					
<b>Category 2 acc. to EN 954-1</b>					
Evaluation unit	up to 6 light barrier pairs can be connected	X	<b>3RG78 25-1CB1</b>	1 unit	0.200

# SIGUARD Light Barriers

Light barriers, Category 2 with evaluation unit,  
Light barriers, Category 4

## Dimension drawings

3RG78 23 light barrier

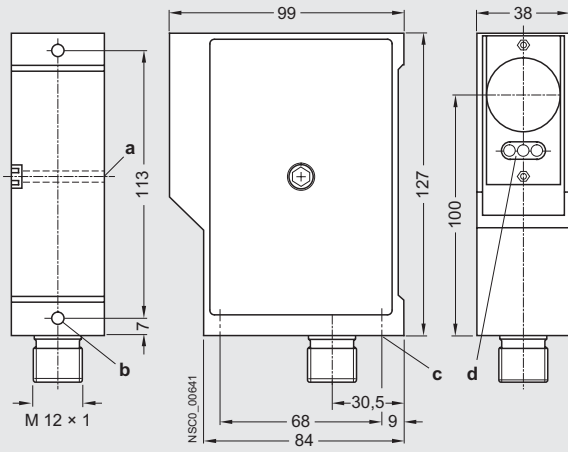

- a = Device mounting M 6 × 12
- b = Device mounting M 6 × 9
- c = Device mounting M 6 × 9
- d = LED

3RG78 24 light barrier

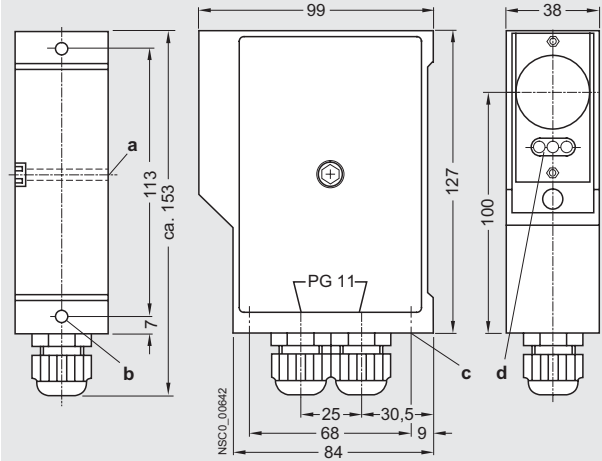

- a = Device mounting M 6 × 12
- b = Device mounting M 6 × 9
- c = Device mounting M 6 × 12
- d = LED

3RG78 25 evaluation unit

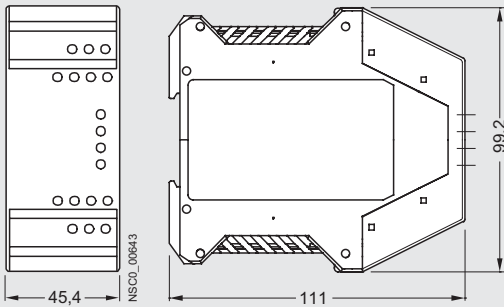

# SIGUARD Switch Strips

## Switch strips to Category 4

### Overview

The SIGUARD switch strips for machine construction protect against crushing on dangerous edges. If the switch strip is actuated or if a fault occurs in the switch strip or connecting cables, the output circuit trips and the drive is halted.

The switch strips are approved in conjunction with the appropriate evaluation unit for Category 4 to EN 954-1.

### Design

The monitoring system comprises the 3RG78 55 switch strip and the 3RG78 57 evaluation unit.

The switch strip comprises the mounting strip (aluminum strip), the sensor strip (rubber strip) as well as an infrared light barrier. The light barrier comprising the transmitter and receiver has a sensing range of 0.5 up to 10 m.

The evaluation unit is installed in a narrow enclosure (22.5 mm width) for standard rail mounting. For each switch strip, i.e. a transmitter and receiver combined, a separate evaluation unit is required.

A three-wire cable connects the transmitter and receiver to the evaluation unit.

### Installation

The mounting strip is cut to size and fitted to the edge to be protected.

The rubber strip is cut to size and inserted in the mounting strip. The transmitter and receiver are plugged into the left and right of the cavity of the rubber strip.

The brown, green and white cores must be connected color-coded to the evaluation unit.

The infrared light beam between the transmitter and the receiver is routed along the rubber strip. It is reflected from the smooth inner surface of the strip. This allows the rubber strip to be curved to a certain extent without switch-off occurring.

### Functions

Due to the dynamic nature of the circuit, every fault is detected. In the event of a fault or when the strip is operated, the monitoring unit switches to the safe state. The restart must be acknowledged via an external circuit (e.g. by means of a Ready/On button).

The status of the unit is indicated via two LEDs (supply voltage, enable) on the front plate.

### Outputs

The evaluation unit features:

- Two positively driven relay outputs which are used as enabling circuits
- A semiconductor output with no relevance for safety (signaling output) is used to report the fault to the controller (npn open collector)

## Technical specifications

### Evaluation unit

Type	3RG78 57
Approvals	Category 4 to EN 954-1
Overtoltage category acc. to EN 60664	3 (4 kV)
Operating voltage	24 V DC (+20%/-10%)
Power consumption	< 4 W
Protection of the supply voltage	1 A (slow)
Output contacts	2 NO (safety) / 1 NC (semicond., switching to N potential)
Response time	Approx. 32 ms
Continuous thermal current	4 A
Switching current	max. 4 A
Switching voltage	max. AC 250 V, 50/60 Hz
Switching power (AC)	max. 1250 VA
Status indication	
• Power	Green LED
• Channel	Green LED
Mechanical endurance	30 mill. make and break operations
Degree of protection to IEC 60529	IP20 terminal casing
Ambient temperature	+5 ... +55 °C
Mounting of enclosure	Snap mounting on 35 mm standard rail acc. to EN 50022
Mounting position	Any



### Switch strip (rubber strip)

Type	3RG78 55
Material	EPDM, 60 Shore
Dimensions (W × H)	25 mm × 30 mm
Temperature resistance	
• temporarily	-40 ... +150 °C
• continuously	-30 ... +120 °C
Substance resistance	Ozone; oil limited extent, fuels, solvents, acids

# SIGUARD Switch Strips

## Switch strips to Category 4

### Selection and ordering data

Version	Range	Length	DT	Order No.	PS*	Weight per PU approx.
	m	m				kg
<b>Optical safety switch strips</b>						
	<b>Transmitter/receiver sensors</b> receiver cable length 3 m, transmitter cable length 10.5 m	0.5 ... 10	A	<b>3RG78 55-1RG</b>	1 unit	0.200
	<b>Sensor strip</b> (rubber strip)	1 2.5 5 10	A A A A	<b>3RG78 55-2BB</b> <b>3RG78 55-2BD</b> <b>3RG78 55-2BF</b> <b>3RG78 55-2BG</b>	1 unit 1 unit 1 unit 1 unit	0.356 0.820 1.550 4.090
	<b>Mounting strip</b> (aluminum strip)	1 2.5	A A	<b>3RG78 55-3BB</b> <b>3RG78 55-3BD</b>	1 unit 1 unit	0.185 0.452
Application	Actuation	Achievable category to EN 954-1	DT	Order No.	PS*	Weight per PU approx.
						kg
<b>DC 24 V evaluation units</b>						
	Monitoring of safety switch strips	Dynamic signal	4	A	<b>3RG78 57-1BD</b>	1 unit 0.220

### Dimension drawings

3RG78 55-1R. send/receive sensors

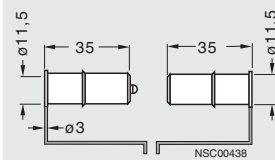

3RG78 55-2B. sensor block

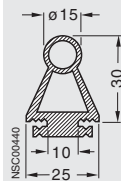

3RG78 55-3B. mounting block

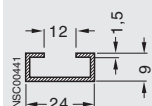

3RG78 57-1BD evaluation unit

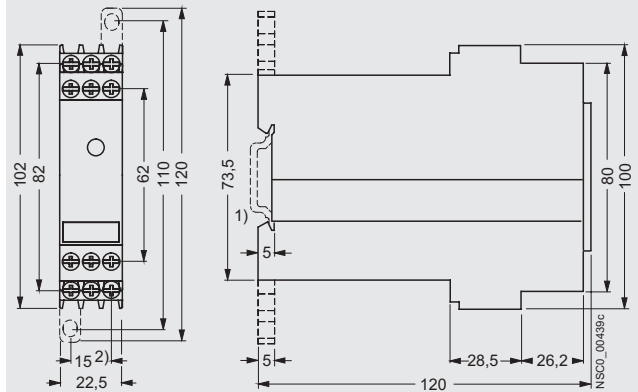

\* This quantity or a multiple thereof can be ordered

# SIGUARD Signaling Columns

## General data

### Overview



Two product series are available:

- 8WD42
  - Thermoplast enclosure, diameter 50 mm
  - IP54 degree of protection
- 8WD44
  - Thermoplast enclosure, diameter 70 mm
  - Advanced design and significantly improved illumination
  - Fast and flexible connection using spring-loaded terminals
  - Integrated IP65 degree of protection

### Area of application

8WD4 signaling columns are used in machines or in automatic processes for monitoring complex procedures or as visual or acoustic warning devices in emergency situations, for example, for displaying individual assembly stages.

#### Communication capability – connection to AS-Interface

The 8WD4 signaling columns can be directly connected to the AS-Interface bus system via an adapter element that can be integrated. This reduces wiring effort. The two-wire cable is fixed to the screw terminals in the connection element.

The adapter element must be the first module to be positioned on the connection element. A maximum of 4 further signal elements can then be used.

### Design

8WD4 signaling columns can be combined as required as modular components and are available in two diameters: 50 mm and 70 mm.

The separate signaling elements are mechanically joined with a bayonet mechanism for electrical reliability and vibration resistance. Tools are not required. Up to five signaling elements (four in the case of 8WD42) can be connected to one connecting element. The bracket for two-sided mounting permits, in the case of the 8WD44 signaling columns, the installation of two connection elements and therefore up to ten signaling elements in a single location.

Signal elements are available in the following versions:

- Steady-light element (bulb, LED)
- Repeated-flash light element (incandescent lamp, LED)
- Single-flash light element
- Rotating-beacon element (LED)
- Buzzer element
- Siren element

The tone of the buzzer element can be altered as desired between a pulsating and a continuous tone by means of a jumper in the buzzer element.

The amplification of the siren element can be selected in the 100 dB version via an integrated potentiometer. It is possible to set 8 sounds via a DIP switch.

The signaling elements are wired via the screw terminals in the connection element.

### Installation

#### Floor mounting

The 8WD42 signaling columns are mounted on the floor with a 8WD42 08-0DE plastic foot.

The 8WD44 signaling columns can be directly screwed onto the connection element for floor mounting.

#### Pipe mounting

Pipes are available in various lengths from 150 mm to 1000 mm. A special molded foot is recommended for pipes of more than 500 mm in length to improve stability.

#### Angle mounting

The supplementary component for fixing at a 90° angle, e.g. to walls is directly attached to the connection element. A special connection element for angle mounting is required for the 8WD44 signaling columns.

#### Single-hole mounting

The 8WD42 signaling columns can be fixed using a drilled hole using the adapter for single-hole mounting. It is screwed in place from below.

#### Magnetic fixing

The adapter with the sideways cable outlet can also be ordered with magnetic fixing as a special version. This offers easy, flexible mounting on metal plates or panels which is also extremely resistant to shocks.

#### Cable outlet

The connecting cables can either be guided downwards or sideways through the cable gland via an adapter that can be screwed under the foot. This makes wiring easier if there is no access from below.



### Technical specifications









#### Signaling columns

Type	8WD42	8WD44
<b>Enclosure</b>	Thermoplastic (polyamide), impact-resistant, black	Thermoplastic (polyamide), impact-resistant, black
<b>Light elements</b>	Thermoplastic (polycarbonate)	Thermoplastic (polycarbonate)
<b>Fixing</b>		
• Horizontal (floor mounting, foot with Ø 25-mm pipe)	✓	✓
• Horizontal (single-hole mounting)	✓	–
• Vertical with bracket	✓	✓
<b>Rated voltage, current input</b>		
With incandescent lamp (AC values for 50/60 Hz)		
• Steady light	AC/DC 12 V/24 V/115 V/230 V	AC/DC 12 V/24 V/115 V/230 V
• Repeated-flash light	AC/DC 24 V/125 mA; AC 115 V/20 mA; AC 230 V/15 mA	AC/DC 24 V/125 mA; AC 115 V/20 mA; AC 230 V/15 mA
• Single-flash light	–	DC 24 V/125 mA; AC 115 V/20 mA; AC 230 V/35 mA
• Max. inrush current, repeated-flash/ single-flash light	–	500 mA
With integrated LED		
• Steady light	AC/DC 24 V/60 mA	AC/DC 24 V/45 mA; AC/DC 115 V/25 mA; AC 230 V/25 mA
• Repeated-flash light	–	AC/DC 24 V/40 mA
• Rotating beacon	–	AC/DC 24 V/70 mA
<b>Acoustic elements</b>		
• Buzzer element (Tone: pulsating or continuous, 85 dB)	AC/DC 24 V/25 mA; AC/DC 115 V/25 mA; AC 230 V/25 mA	AC/DC 24 V/25 mA; AC/DC 115 V/25 mA; AC 230 V/25 mA
• Siren element (8 tones + amplification can be set, 100 dB)	–	AC/DC 24 V/80 mA; AC 115 V/30 mA; AC 230 V/16 mA
• Siren element (108 dB)	–	DC 24 V/100 mA
<b>Power consumption</b>		
• Bulbs, base BA 15d	Max. 5 W	7 W
• Single-flash light	–	Flash energy 2 Ws
<b>Conductor</b>	M 3 screw connection $\leq 2.5 \text{ mm}^2 \leq 0.5 \text{ Nm}$	M 3 screw connection $\leq 2.5 \text{ mm}^2 \leq 0.5 \text{ Nm}$
<b>Degree of protection</b>		
• Light elements	IP54	IP65 (gasket premounted as standard with every module)
• Acoustic elements	IP54	IP65
<b>Operating temperature</b>	–20 °C ... +50 °C	–30 °C ... +50 °C

# SIGUARD Signaling Columns

## Signaling columns with 50 mm diameter

### Selection and ordering data

Version	Color	DT	Order No.	PS*	Weight per PU approx. kg	DT	Order No.	PS*	Weight per PU approx. kg	DT	Order No.	PS*	Weight per PU approx. kg	
<b>Light elements for incandescent lamp/LED, BA 15d base</b>														
	<b>Continu-ous light element <sup>1)</sup></b>		Rated voltage AC/DC 24 ... 230 V											
	red	A	<b>8WD42 00-1AB</b>	1 unit	0.049									
	green	A	<b>8WD42 00-1AC</b>	1 unit	0.048									
	yellow	A	<b>8WD42 00-1AD</b>	1 unit	0.049									
	clear	A	<b>8WD42 00-1AE</b>	1 unit	0.049									
blue	A	<b>8WD42 00-1AF</b>	1 unit	0.048										
	<b>Flashing light element <sup>1)</sup></b>		Rated voltage AC/DC 24 V				Rated voltage AC 115 V				Rated voltage AC 230V			
	red	A	<b>8WD42 20-1BB</b>	1 unit	0.053	A	<b>8WD42 40-1BB</b>	1 unit	0.054	A	<b>8WD42 50-1BB</b>	1 unit	0.055	
	green	A	<b>8WD42 20-1BC</b>	1 unit	0.054	A	<b>8WD42 40-1BC</b>	1 unit	0.054	A	<b>8WD42 50-1BC</b>	1 unit	0.054	
	yellow	A	<b>8WD42 20-1BD</b>	1 unit	0.053	A	<b>8WD42 40-1BD</b>	1 unit	0.054	A	<b>8WD42 50-1BD</b>	1 unit	0.054	
	clear	A	<b>8WD42 20-1BE</b>	1 unit	0.054	D	<b>8WD42 40-1BE</b>	1 unit	0.055	A	<b>8WD42 50-1BE</b>	1 unit	0.054	
	blue	A	<b>8WD42 20-1BF</b>	1 unit	0.052	D	<b>8WD42 40-1BF</b>	1 unit	0.055	A	<b>8WD42 50-1BF</b>	1 unit	0.054	
	<b>Light elements with integrated LED</b>													
		<b>Steady-light element</b>		red	A	<b>8WD42 20-5AB</b>	1 unit	0.051	–			–		
		green	A	<b>8WD42 20-5AC</b>	1 unit	0.051	–					–		
yellow		A	<b>8WD42 20-5AD</b>	1 unit	0.051	–					–			
<b>Acoustic elements</b>														
	<b>Buzzer element</b> 80 dB, adjustable tone: pul- sating or continuous	A	<b>8WD42 20-0FA</b>	1 unit	0.060	A	<b>8WD42 40-0FA</b>	1 unit	0.066	A	<b>8WD42 50-0FA</b>	1 unit	0.066	
<b>Connection element</b>														
	<b>Connection ele- ment with end cover</b> for mounting on pipes, floors and brackets		For all voltages		A	<b>8WD42 08-0AA</b>	1 unit	0.084	–		–			
	1) Lamp not included in scope of supply. Please order separately.													
Version	Rated voltage V	DT	Order No.	PS*	Weight per PU approx. kg									
<b>Accessories</b>														
	<b>Foot, single</b>		plastic, for mounting on pipes	A	<b>8WD43 08-0DB</b>	1 unit	0.042							
			plastic, for mounting on floor	A	<b>8WD42 08-0DE</b>	1 unit	0.036							
	<b>Socket for foot</b>		Side cable outlet	A	<b>8WD43 08-0DD</b>	1 unit	0.074							
			side cable outlet, with magnetic fixing <sup>1)</sup>	A	<b>8WD43 08-0DE</b>	1 unit	0.321							
<b>Pipe, single</b>		<a href="#">see 70 mm diameter, page 11/135</a>												
	<b>Bracket for wall mounting</b>			A	<b>8WD42 08-0CA</b>	1 unit	0.110							
	<b>Adapter for single-hole mounting</b>			A	<b>8WD42 08-0EH</b>	1 unit	0.115							
	<b>Incandescent lamp, 5 W</b>													
	Base BA 15d	24	A	<b>8WD43 28-1XX</b>	1 unit	0.009								
		115	A	<b>8WD43 48-1XX</b>	1 unit	0.009								
		230	A	<b>8WD43 58-1XX</b>	10 units	0.009								
<b>LEDs, BA 15d base</b>		<a href="#">see 70 mm diameter, page 11/135</a>												

1) For horizontal mounting, only 1 element is recommended.

# SIGUARD Signaling Columns

## Signaling columns with 50 mm diameter



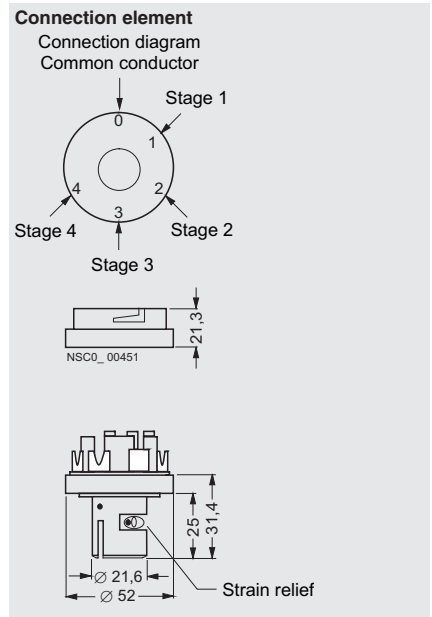
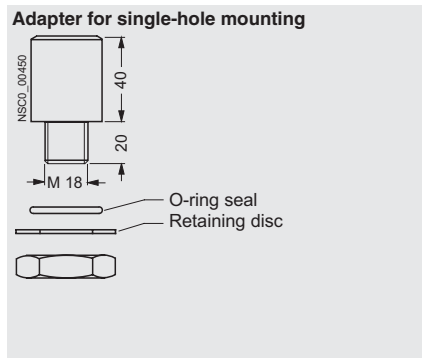
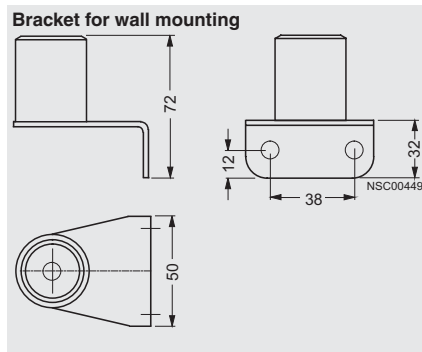
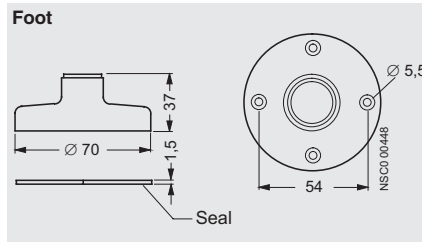
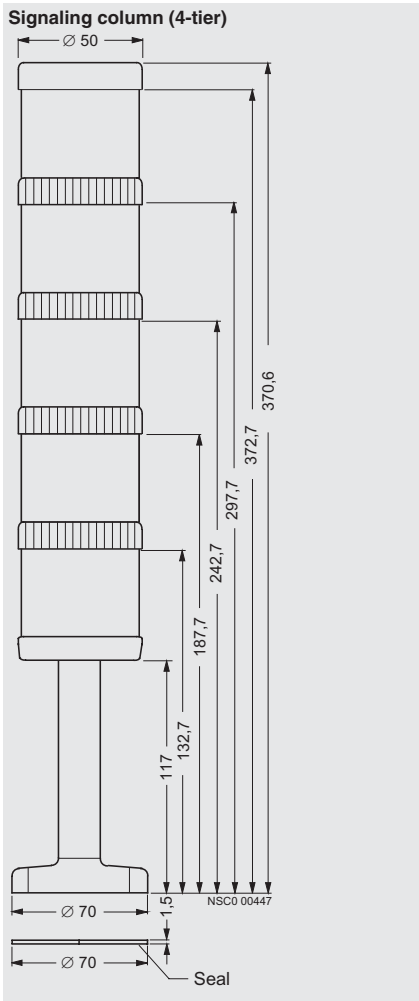

### Dimension drawings



# SIGUARD Signaling Columns

## Signaling columns with 70 mm diameter









### Selection and ordering data

Version	Color	DT	Order No.	PS*	Weight per PU approx. kg	DT	Order No.	PS*	Weight per PU approx. kg	DT	Order No.	PS*	Weight per PU approx. kg	
<b>Light elements for incandescent lamp/LED, BA 15d base</b>														
	<b>Cont. light element<sup>1)</sup></b>		Rated voltage AC/DC 12 ... 230 V											
		red	A	<b>8WD44 00-1AB</b>	1 unit	0.070								
		green	A	<b>8WD44 00-1AC</b>	1 unit	0.069								
		yellow	D	<b>8WD44 00-1AD</b>	1 unit	0.069								
		clear	D	<b>8WD44 00-1AE</b>	1 unit	0.069								
	blue	A	<b>8WD44 00-1AF</b>	1 unit	0.070									
	<b>Flashing light e.<sup>1)</sup></b>		Rated voltage AC/DC 24 V				Rated voltage AC 115 V				Rated voltage AC 230V			
	red	A	<b>8WD44 20-1BB</b>	1 unit	0.078	A	<b>8WD44 40-1BB</b>	1 unit	0.078	A	<b>8WD44 50-1BB</b>	1 unit	0.078	
	green	A	<b>8WD44 20-1BC</b>	1 unit	0.077	A	<b>8WD44 40-1BC</b>	1 unit	0.077	A	<b>8WD44 50-1BC</b>	1 unit	0.078	
	yellow	A	<b>8WD44 20-1BD</b>	1 unit	0.078	A	<b>8WD44 40-1BD</b>	1 unit	0.078	A	<b>8WD44 50-1BD</b>	1 unit	0.077	
	clear	A	<b>8WD44 20-1BE</b>	1 unit	0.078	A	<b>8WD44 40-1BE</b>	1 unit	0.077	A	<b>8WD44 50-1BE</b>	1 unit	0.078	
	blue	A	<b>8WD44 20-1BF</b>	1 unit	0.076	A	<b>8WD44 40-1BF</b>	1 unit	0.078	A	<b>8WD44 50-1BF</b>	1 unit	0.078	
<b>Light elements with integrated flash lamp</b>														
	<b>Single-flash light element with built-in electronic flash</b>		Rated voltage DC 24 V											
	red	D	<b>8WD44 20-0CB</b>	1 unit	0.090	A	<b>8WD44 40-0CB</b>	1 unit	0.088	A	<b>8WD44 50-0CB</b>	1 unit	0.086	
	green	A	<b>8WD44 20-0CC</b>	1 unit	0.091	A	<b>8WD44 40-0CC</b>	1 unit	0.088	A	<b>8WD44 50-0CC</b>	1 unit	0.086	
	yellow	A	<b>8WD44 20-0CD</b>	1 unit	0.090	A	<b>8WD44 40-0CD</b>	1 unit	0.087	A	<b>8WD44 50-0CD</b>	1 unit	0.087	
	clear	A	<b>8WD44 20-0CE</b>	1 unit	0.091	A	<b>8WD44 40-0CE</b>	1 unit	0.088	A	<b>8WD44 50-0CE</b>	1 unit	0.087	
	blue	A	<b>8WD44 20-0CF</b>	1 unit	0.091	A	<b>8WD44 40-0CF</b>	1 unit	0.088	A	<b>8WD44 50-0CF</b>	1 unit	0.088	
<b>Light elements with integrated LED</b>														
	<b>Steady-light element</b>		Rated voltage AC/DC 24 V				Rated voltage AC/DC 115 V							
		red	A	<b>8WD44 20-5AB</b>	1 unit	0.072	A	<b>8WD44 40-5AB</b>	1 unit	0.072	A	<b>8WD44 50-5AB</b>	1 unit	0.074
		green	A	<b>8WD44 20-5AC</b>	1 unit	0.072	A	<b>8WD44 40-5AC</b>	1 unit	0.071	A	<b>8WD44 50-5AC</b>	1 unit	0.073
		yellow	A	<b>8WD44 20-5AD</b>	1 unit	0.072	A	<b>8WD44 40-5AD</b>	1 unit	0.072	A	<b>8WD44 50-5AD</b>	1 unit	0.074
		clear	A	<b>8WD44 20-5AE</b>	1 unit	0.072	A	<b>8WD44 40-5AE</b>	1 unit	0.072	A	<b>8WD44 50-5AE</b>	1 unit	0.074
	blue	A	<b>8WD44 20-5AF</b>	1 unit	0.072	A	<b>8WD44 40-5AF</b>	1 unit	0.072	A	<b>8WD44 50-5AF</b>	1 unit	0.073	
	<b>Repeated-flash light element</b>													
	red	A	<b>8WD44 20-5BB</b>	1 unit	0.072									
	green	A	<b>8WD44 20-5BC</b>	1 unit	0.071									
	yellow	A	<b>8WD44 20-5BD</b>	1 unit	0.072									
	<b>Rotating-beacon element</b>													
	red	A	<b>8WD44 20-5DB</b>	1 unit	0.081									
	green	A	<b>8WD44 20-5DC</b>	1 unit	0.081									
	yellow	A	<b>8WD44 20-5DD</b>	1 unit	0.082									
<b>Acoustic elements</b>														
	<b>Buzzer element</b>		A	<b>8WD44 20-0FA</b>	1 unit	0.084	A	<b>8WD44 40-0FA</b>	1 unit	0.089	A	<b>8WD44 50-0FA</b>	1 unit	0.089
	<b>Siren element, multi-tone, 100 dB, 8 tones and amplification can be set</b>		A	<b>8WD44 20-0EA2</b>	1 unit	0.090	A	<b>8WD44 40-0EA2</b>	1 unit	0.106	A	<b>8WD44 50-0EA2</b>	1 unit	0.100
<b>Siren element 108 dB, IP40</b>		A	<b>8WD44 20-0EA</b>	1 unit	0.123									
<b>Connection elements</b>														
	<b>Connection element and cover</b>		For all voltages											
	Screw terminals													
		• For mounting on pipes	A	<b>8WD44 08-0AA</b>	1 unit	0.111								
		• For mounting on brackets or floors	A	<b>8WD44 08-0AB</b>	1 unit	0.115								
	Spring-loaded terminals													
	• For mounting on pipes	A	<b>8WD44 08-0AD</b>	1 unit	0.103									
	• For mounting on bracket or floor	A	<b>8WD44 08-0AE</b>	1 unit	0.106									

1) Lamp not included in scope of supply. Please order separately.

# SIGUARD Signaling Columns

## Signaling columns with 70 mm diameter

Version	Rated voltage	DT	Order No.	PS*	Weight per PU approx.	
	V				kg	
<b>Accessories</b>						
	<b>Foot with pipe</b>	Pipe length 100 mm	A	<b>8WD43 08-0DA</b>	1 unit 0.063	
	<b>Foot, single</b>	Plastic for mounting on pipes Cast iron, for pipe lengths > 400 mm	A	<b>8WD43 08-0DB</b> <b>8WD43 08-0DC</b>	1 unit 0.042 1 unit 0.327	
	<b>Socket for foot</b>	Side cable outlet	A	<b>8WD43 08-0DD</b>	1 unit 0.074	
		Side cable outlet, with magnetic fixing <sup>1)</sup>	A	<b>8WD43 08-0DE</b>	1 unit 0.321	
	<b>Pipe, single</b>	Length 100 mm	A	<b>8WD42 08-0EF</b>	1 unit 0.030	
		Length 150 mm	A	<b>8WD43 08-0EE</b>	1 unit 0.043	
		Length 250 mm	A	<b>8WD43 08-0EA</b>	1 unit 0.077	
		Length 400 mm	A	<b>8WD43 08-0EB</b>	1 unit 0.124	
		Length 1000 mm	A	<b>8WD43 08-0ED</b>	1 unit 0.301	
	<b>Bracket for wall mounting</b>	for single-sided mounting	A	<b>8WD43 08-0CA</b>	1 unit 0.081	
		for double-sided mounting	A	<b>8WD43 08-0CB</b>	1 unit 0.073	
	<b>Incandescent lamp, 5 W</b>	Base BA 15d	24	A	<b>8WD43 28-1XX</b>	1 unit 0.009
			115	A	<b>8WD43 48-1XX</b>	1 unit 0.009
			230	A	<b>8WD43 58-1XX</b>	10 units 0.009
	<b>LEDs</b>	Base BA 15d	AC/DC 24	A	<b>8WD44 28-6XB</b>	1 unit 0.020
				A	<b>8WD44 28-6XC</b>	1 unit 0.020
				A	<b>8WD44 28-6XD</b>	1 unit 0.019
				A	<b>8WD44 28-6XE</b>	1 unit 0.020
				A	<b>8WD44 28-6XF</b>	1 unit 0.025
				AC 115	A	<b>8WD44 48-6XB</b>
			A		<b>8WD44 48-6XC</b>	1 unit 0.015
			A		<b>8WD44 48-6XD</b>	1 unit 0.020
			A		<b>8WD44 48-6XE</b>	1 unit 0.019
			A		<b>8WD44 48-6XF</b>	1 unit 0.019
			AC 230		A	<b>8WD44 58-6XB</b>
				A	<b>8WD44 58-6XC</b>	1 unit 0.018
A	<b>8WD44 58-6XD</b>	1 unit 0.019				
A	<b>8WD44 58-6XE</b>	1 unit 0.020				
	<b>Bracket for floor mounting</b>		A	<b>8WD44 08-0CC</b>	1 unit 0.057	
	<b>Bracket for base mounting</b>		A	<b>8WD44 08-0CD</b>	1 unit 0.044	
	<b>Labeling panel</b>	with fixing material for pipe mounting Ø 25 mm Text area/step 50 mm × 140 mm Suitable for standard labels, e.g. • Zweckform 3425 • Herma 4457	A	<b>8WD44 08-0FA</b>	1 unit 0.350	

1) For horizontal mounting, only 1 element is recommended.

# SIGUARD Signaling Columns

## Signaling columns with 70 mm diameter

### Dimension drawings

Signaling column (5-tier)

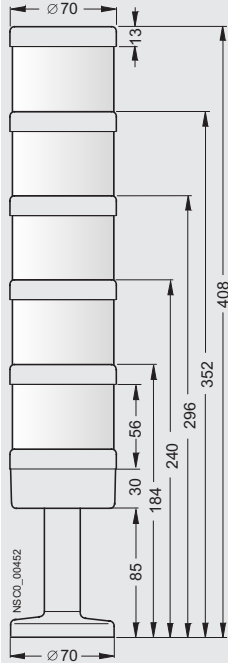

Connection elements

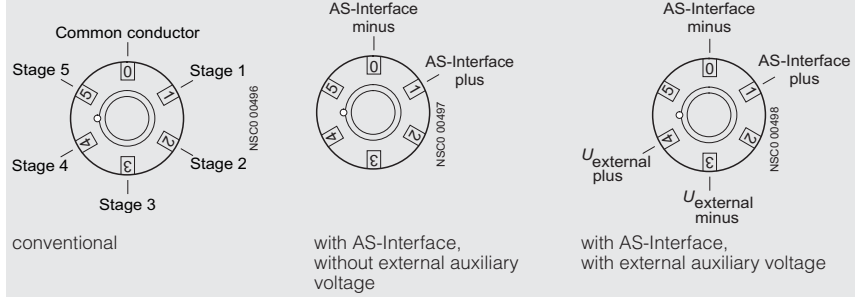

Connection element and cover for mounting on pipes

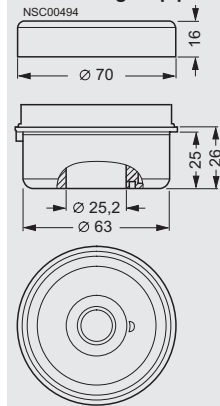

Connection element and cover for mounting on floor/bracket

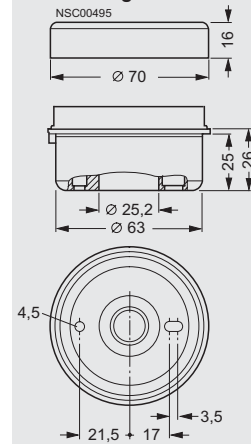

Foot with pipe

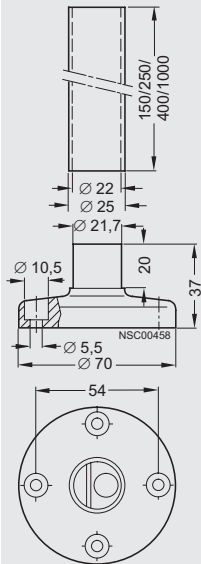

Bracket for single-sided mounting

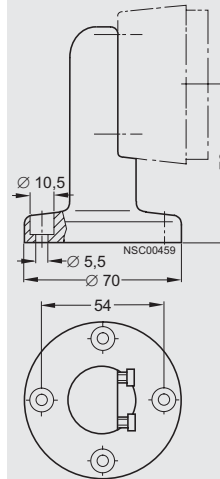

Bracket for double-sided mounting

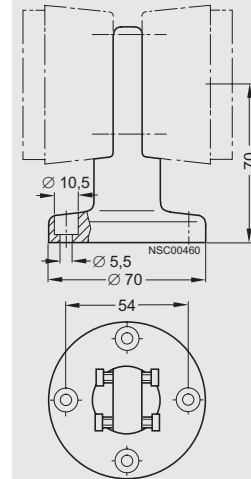

# SIGUARD Signaling Columns

## AS-Interface connection for signaling columns

### Overview

#### Communication capability – connection to AS-Interface

The 8WD4 signaling columns can be directly connected to the AS-Interface bus system via an adapter element that can be integrated. This reduces wiring effort. The two-wire cable is fixed to the screw terminals in the connection element.



The adapter element must be the first module to be positioned on the connection element. A maximum of 4 further signal elements can then be used.

### Technical specifications

#### AS-Interface adapter elements

Type	8WD42 with external auxiliary voltage	8WD44 without external auxiliary voltage	8WD44 with external auxiliary voltage
IO code/ID code	8/F	8/F	8/F
Supply	via bus cable	via bus cable	via bus cable
• Operating voltage	18.5 V ... 31.6 V	18.5 V ... 31.6 V	18.5 V ... 31.6 V
• Current input $I_{max}$	50 mA	210 mA	75 mA
Protective measures			
• Watchdog	✓	✓	✓
• Short-circuit/overload protection	external upstream fuse M 1.6 A	✓	external upstream fuse M 1.6 A
• Polarity reversal protection	✓	✓	✓
• Induction protection	not applicable	✓	not applicable
Outputs			
• Load voltage	4 relay outputs External auxiliary voltage DC 0 V ... 30 V AC 0 V ... 230 V	4 solid-state outputs via bus cable	4 relay outputs External auxiliary voltage DC 10 V ... 120 V AC 10 V ... 230 V
• Current carrying capacity $\Sigma I_{max}$	1.5 A	200 mA	1.5 A
Degree of protection	IP54	IP65	IP65
Operating temperature	-20 °C ... +50 °C	-20 °C ... +50 °C	-20 °C ... +50 °C

### Selection and ordering data

Version	Rated voltage	DT	Order No.	PS*	Weight per PU approx.
	V				kg
<b>Accessories for 50 mm diameter</b>					
	<b>AS-Interface adapter element</b> with ext. auxiliary voltage	24	A	<b>8WD42 28-0BB</b>	1 unit 0.074
<b>Accessories for 70 mm diameter</b>					
	<b>AS-Interface adapter element</b>				
	• without ext. auxiliary voltage	for 4 signaling elements up to 200 mA	24	A	<b>8WD44 28-0BA</b> 1 unit 0.079
	• with ext. auxiliary voltage	for 4 signaling elements up to 1.5 A	24	A	<b>8WD44 28-0BB</b> 1 unit 0.111

\* This quantity or a multiple thereof can be ordered

# SIGUARD Integrated Signal Lamps

## Integrated signal lamps with 70 mm diameter

### Overview



Characteristics:

- Thermoplast enclosure, diameter 70 mm
- IP65 degree of protection
- Rated voltage UC 24, 115 V to 230 V

### Design

8WD53 SIGUARD integrated signal lamps can be mounted directly at any point of the machine for the purpose of giving visual signals. They are mounted by means of a Pg 29 screw base with nut.

The special shape of the SIGUARD integrated signal lamps means that the light is emitted optimally in every direction (to the sides and upwards).

All SIGUARD integrated signal lamps have a high degree of protection IP65 and are made of a material highly resistant to impact.

Steady lights (with incandescent lamp or LED) and single-flash lights are available in the following colors: red, green, yellow, clear and blue.

The LED versions of the integrated signal lamps offer a considerably longer service life than the incandescent lamp versions.

LED lights are available as a steady light, repeated-flash light and rotating beacon.

### Technical specifications

<b>Enclosure</b>	PC/ABS composite impact-resistant, black
<b>Spherical cap</b>	Thermoplastic (polycarbonate), impact-resistant to 20 J
<b>Fixing</b>	Ø 37 mm hole (Pg 29)
<b>Rated voltage</b> (AC values at 50 Hz)	
• Continuous light, BA 15d (incandescent lamp)	AC/DC 24 V/115 V/230 V; 5 W
• Continuous light, BA 15d (LED)	AC/DC 24 V/115 V/230 V
• Single-flash lamp	AC/DC 24 V/125 mA; AC 115 V/20 mA; AC 230 V/15 mA
• Lights with integrated LED	AC/DC 24 V/70 mA
<b>Single-flash power</b>	2 Ws/approx. 1 Hz
<b>LED lamps</b>	
• Repeated flash lamp	Flash frequency approx. 1 Hz
• Rotating beacon	Rotating frequency approx. 120 rpm
<b>Inrush current</b>	
• LED lamp	< 0.5 A
• Single-flash lamp	< 0.5 A
<b>Cable connection</b>	Radial or axial
<b>Degree of protection</b>	IP65
<b>Ambient temperature</b>	
• Steady light (bulb)	-20 ... +60 °C
• Single-flash lamp, LED	-20 ... +50 °C



# SIGUARD Integrated Signal Lamps

## Integrated signal lamps with 70 mm diameter

### Selection and ordering data

Version	Color	DT	Order No.	PS*	Weight per PU approx. kg	DT	Order No.	PS*	Weight per PU approx. kg	DT	Order No.	PS*	Weight per PU approx. kg
---------	-------	----	-----------	-----	-----------------------------	----	-----------	-----	-----------------------------	----	-----------	-----	-----------------------------

#### Lights for incandescent lamp/LED, BA 15d base



##### Continuous light <sup>1)</sup>

Rated voltage  
AC/DC 24 ... 230 V

red	A	<b>8WD53 00-1AB</b>	1 unit	0.130
green	A	<b>8WD53 00-1AC</b>	1 unit	0.127
yellow	A	<b>8WD53 00-1AD</b>	1 unit	0.128
clear	A	<b>8WD53 00-1AE</b>	1 unit	0.127
blue	A	<b>8WD53 00-1AF</b>	1 unit	0.126

#### Lights with integrated flash lamp

Rated voltage  
AC/DC 24 V

Rated voltage  
AC 115 V

Rated voltage  
AC 230 V

Single-flash lamp with integrated electronic flash	Color	DT	Order No.	PS*	Weight per PU approx.	DT	Order No.	PS*	Weight per PU approx.	DT	Order No.	PS*	Weight per PU approx.
red	A	<b>8WD53 20-0CB</b>	1 unit	0.146	A	<b>8WD53 40-0CB</b>	1 unit	0.144	A	<b>8WD53 50-0CB</b>	1 unit	0.142	
green	A	<b>8WD53 20-0CC</b>	1 unit	0.153	A	<b>8WD53 40-0CC</b>	1 unit	0.143	A	<b>8WD53 50-0CC</b>	1 unit	0.142	
yellow	A	<b>8WD53 20-0CD</b>	1 unit	0.147	A	<b>8WD53 40-0CD</b>	1 unit	0.144	D	<b>8WD53 50-0CD</b>	1 unit	0.143	
clear	D	<b>8WD53 20-0CE</b>	1 unit	0.150	A	<b>8WD53 40-0CE</b>	1 unit	0.150	A	<b>8WD53 50-0CE</b>	1 unit	0.145	
blue	A	<b>8WD53 20-0CF</b>	1 unit	0.152	D	<b>8WD53 40-0CF</b>	1 unit	0.151	A	<b>8WD53 50-0CF</b>	1 unit	0.146	

#### Lights with integrated LED



##### Steady light

red	A	<b>8WD53 20-5AB</b>	1 unit	0.129	—	—
green	A	<b>8WD53 20-5AC</b>	1 unit	0.129	—	—
yellow	A	<b>8WD53 20-5AD</b>	1 unit	0.128	—	—

##### Repeated flash lamp

red	A	<b>8WD53 20-5BB</b>	1 unit	0.129	—	—
green	D	<b>8WD53 20-5BC</b>	1 unit	0.142	—	—
yellow	A	<b>8WD53 20-5BD</b>	1 unit	0.129	—	—

##### Rotating beacon

red	A	<b>8WD53 20-5DB</b>	1 unit	0.138	—	—
green	A	<b>8WD53 20-5DC</b>	1 unit	0.137	—	—
yellow	A	<b>8WD53 20-5DD</b>	1 unit	0.139	—	—

For bulbs and LEDs, see page 11/135.

1) Lamp not included in scope of supply. Please order separately.

### Dimension drawings

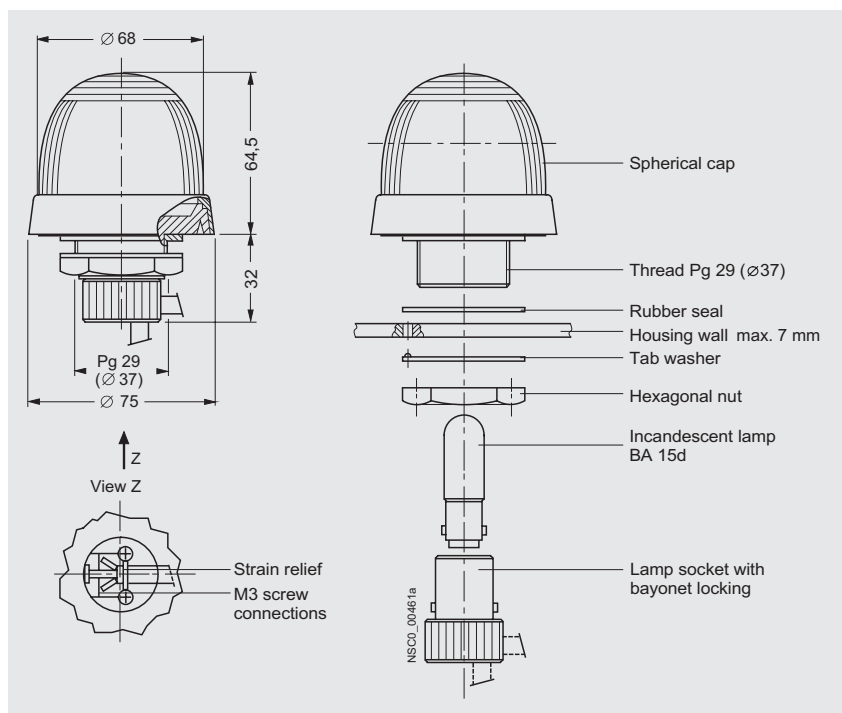

## System overview

### Overview

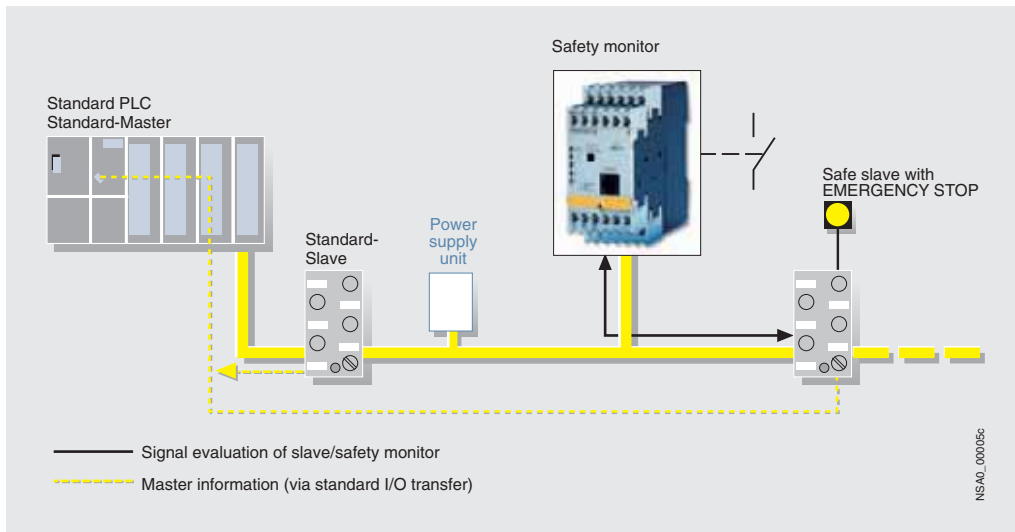

The Safety at Work concept supports the direct integration of safety-related components, such as EMERGENCY-STOP switches, protective door switches or safety light arrays, in the AS-Interface network. These are fully compatible with the familiar AS-Interface components (masters, slaves, power supply units, etc.) in accordance with EN 50295 and are operated in conjunction with them on the yellow AS-Interface cable.

Siemens can supply all the components for constructing a fail-safe AS-Interface network.

Advantages at a glance

- Safety-related and standard data on the same bus
- No failsafe PLC or special master is required
- Safe signals can be combined in groups
- Simple system structure thanks to standardized AS-Interface technique
- Existing systems can be expanded quickly and easily.

#### Safety monitor

The safety monitor checks the information transmitted over AS-Interface, i.e. the master call to and response from the safe slave, and places the equipment into a safe state in the event of an interruption in the safety circuit or malfunctioning of the safety sensors.

For the standard AS-Interface bus stations, the master continues to perform the data transmission function between a PLC and the bus stations (sensors and actuators).

#### K45F safe compact modules

The K45F compact module is available in a well-proven design, which is equipped with 2 "safe" inputs. For operation up to Category 2, both inputs can be separately assigned; if Category 4 is required, a two-channel input is available on the module.

#### K60F safe compact module

The K60F safe compact module has 2 "safe" inputs. For operation up to Category 2, both inputs can be separately assigned; if Category 4 is required, a two-channel input is available on the module. Two standard outputs are also available on the module. The K60F is available in two versions:

- Power supply of the outputs over the yellow cable ( $U_{AS-i}$ )
- Auxiliary power supply of the outputs over the black cable ( $U_{aux}$ )

#### Safe S22.5F slimline module

This family of safe modules has been expanded with the version for the control cabinet.

The safe S22.5F slimline module has two safe inputs. Depending on the connection of the inputs, Category 2 or 4 to EN 954-1 can be achieved.

- It is possible to achieve Category 2 by connecting to a single-channel mechanical sensor. The second input must be bridged.
- It is possible to achieve Category 4 by connecting to a two-channel mechanical sensor.

#### SIGNAL EMERGENCY-STOP

EMERGENCY-STOP devices can be directly connected via the standard AS-Interface with safety-oriented communication. This only applies to EMERGENCY-STOP devices of the SIGNAL 3SB3 series for front panel mounting and for installation in an enclosure.

#### SIGUARD light curtains and light arrays

The light curtains and light arrays of Category 4 to EN 954-1 offer active optical protection for persons at machines. They can be connected to AS-Interface directly and safely as an option.

#### SIGUARD position switches

SIGUARD position switches can be directly connected via the standard AS-Interface with safety-oriented communication. The safety functions no longer have to be conventionally wired up.

#### SIGUARD laser scanners

The SIGUARD laser scanner is an optical area sensor for protection in danger zones up to Category 3 according to EN 954-1 which is also available with a safe AS-Interface connection.

#### Ordering data and further information

See "AS-Interface Safety at Work" in Catalog IK PI.

### AS-Interface position switch

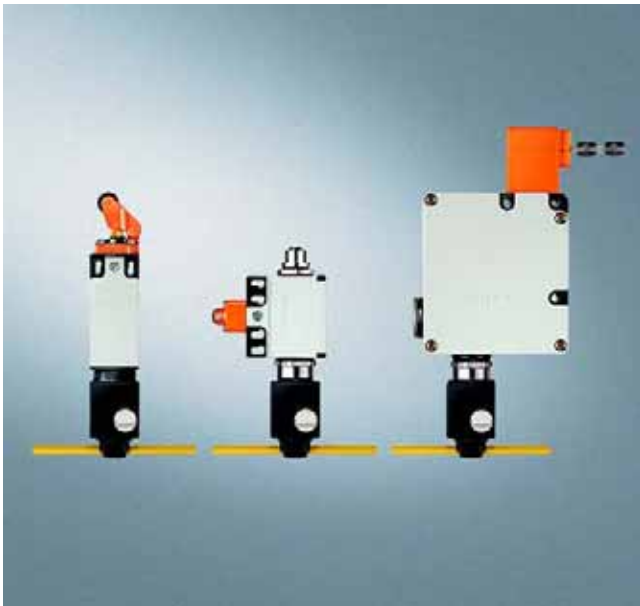

Position switches from left to right:  
standard, standard with M12 connector, with tumbler

SIGUARD position switches can now be directly connected via the standard AS-Interface with safety-oriented communication. The safety functions no longer have to be conventionally wired up.

The function of the position switches is to produce electrical signals corresponding to the positions of the moving machinery.

#### Position switch with separate actuator

Position switches with separate actuator are used where the position of doors, covers or safety screens must be monitored for safety reasons.

The position switch can only be operated with the matching triple-coded actuator. Simple overruling by hand or auxiliary devices is impossible.

#### Position switches with tumbler

The position switches with tumbler are exceptional safety-related devices which prevent an unforeseen or intentional opening of protective doors, protective grilles or other covers as long as a dangerous situation is present i.e. follow-on motion of the switched off machine.

The safety switch with tumbler basically has two main functions:

- Enabling the machine with closed and locked protective system
- Locking the machine with opened protective system.

The position switch can only be operated with the matching coded actuator. Simple overruling by hand or auxiliary devices is impossible.

### AS-Interface cable-operated switch

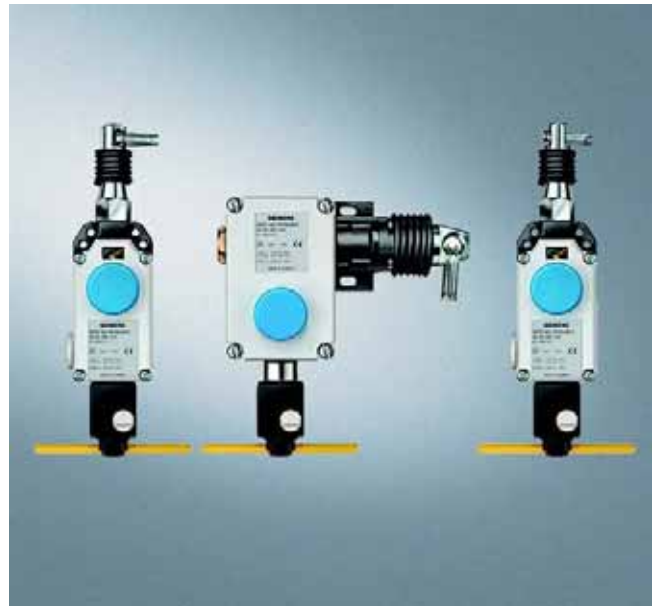

Cable-operated switch for various lengths of pull-wire

AS-Interface cable-operated switches can now be directly connected via the standard AS-Interface with safety-oriented communication. The safety functions no longer have to be conventionally wired up.

SIGUARD cable-operated switches are used for monitoring or for EMERGENCY-STOP facilities on particularly endangered system sections.

As the effective range of a cable-operated switch is only limited by the length of the pull-wire, large systems can also be protected.

Switches with latching for implementation in EMERGENCY-STOP equipment correspond to the EN 418 standard. The contacts are positively driven.

The AS-Interface cable-operated switches are prepared for operation by pretensioning the pull-wire or rope. When the rope is pretensioned, the cable-operated switch must first be released to return it to the initial position. Further information

#### Ordering data and further information

See "AS-Interface Safety at Work" in Catalog IK PI.

# Safety at Work

Notes

11

